





Chapter 10 Suspension and steering systems

Contents

Balljoints - check and renewal	7	Rear trailing arms (3-Series) - removal and refitting	13
Control arm (3-Series) - inspection, removal and refitting, and bush renewal	3	Rear trailing arms (5-Series) - removal and refitting	14
Control and thrust arms (5-Series) - inspection, removal and refitting, and bush renewal	4	Rear wheel bearings - renewal	15
Front anti-roll bar - removal and refitting	2	Steering and suspension check	See Chapter 1
Front hub and wheel bearing assembly - removal and refitting	8	Steering box (5-Series) - removal and refitting	21
Front strut assembly - removal and refitting	5	Steering gear boots (3-Series) - renewal	18
General information	1	Steering linkage (5-Series) - inspection, removal and refitting	20
Power steering fluid level check	See Chapter 1	Steering system - general information	16
Power steering pump - removal and refitting	22	Steering wheel - removal and refitting	24
Power steering system - bleeding	23	Strut or shock absorber/coil spring - renewal	6
Rack-and-pinion steering gear (3-Series) - removal and refitting	19	Suspension and steering checks	See Chapter 1
Rear anti-roll bar - removal and refitting	12	Track rod ends - removal and refitting	17
Rear coil springs (3-Series) - removal and refitting	10	Tyre and tyre pressure checks	See Chapter 1
Rear shock absorbers (3-Series) - removal and refitting	9	Tyre rotation	See Chapter 1
Rear shock absorber/coil spring assembly (5-Series) - removal and refitting	11	Wheel alignment - general information	26
		Wheels and tyres - general information	25

Degrees of difficulty

Easy , suitable for novice with little experience 	Fairly easy , suitable for beginner with some experience 	Fairly difficult , suitable for competent DIY mechanic 	Difficult , suitable for experienced DIY mechanic 	Very difficult , suitable for expert DIY or professional 
---	--	--	---	--

Specifications

General

Power steering fluid type See Chapter 1

Tyres

Tyre sizes

3-Series, E30	
316	175/70x14
316i	175/70x14, 195/65x14
318i	175/70x14
320i	195/65x14
325i	195/65x14, 200/60x356, 205/55x15
5-Series, E28 ("old-shape")	
518	175x14
518i	175x14
525i	175x14, 195/70x14
528i	195/70x14
535i and M535i	220/55x390
5-Series, E34 ("new-shape")	
518i	195/65x15
520i	195/65x15, 225/60x15
525i	195/65x15, 205/65x15, 225/65x15
530i	205/65x15, 225/60x15
535i	225/60x15, 240/45x415
Tyre pressures	See Chapter 1 Specifications

10•2 Suspension and steering systems

Torque wrench settings	Nm	Torque wrench settings	Nm
Front suspension		Rear suspension	
Strut damper rod nut		Rear shock absorber (3-Series)	
Rod with external hexagon	65	Shock absorber-to-upper mounting bracket	12 to 15
Rod with internal hexagon	44	Shock absorber-to-trailing arm	71 to 85
Strut cartridge threaded collar	130	Rear shock absorber (5-Series)	
Strut upper mounting nuts	22	Lower mounting bolt	125 to 142
Front control arm (3-Series)		Upper mounting nut	22 to 24
Control arm-to-steering knuckle balljoint nut	64	Upper spring mounting-to-shock absorber locknut	22 to 24
Control arm-to-subframe balljoint nut	83	Trailing arms (3-Series)	
Control arm bush bracket bolts	41	Trailing arm-to-lower mounting	71 to 85
Lower control arm (5-Series)		Trailing arm-to-anti-roll bar	22 to 23
Control arm-to-steering arm balljoint stud nut	85	Trailing arms (5-Series)	
Control arm pivot bolt	77	Trailing arm-to-rear axle carrier (rubber bush through-bolt and nut)	66
Thrust arm (5-Series)		Trailing arm-to-axle carrier connecting link (1983-on)	126
Thrust arm-to-steering arm balljoint stud nut	85	Rear wheel bearing drive flange axle nut (5-Series)	
Thrust arm through-bolt	130	M22	175 to 210
Front hub (wheel bearing) nut	290	M27	235 to 260
Steering arm-to-strut bolts (5-Series)	65		
Anti-roll bar (3-Series)		Steering system	
Anti-roll bar-to-connecting link bolt	41	Steering wheel retaining nut	79
Anti-roll bar mounting brackets-to-subframe	22	Steering column universal joint pinch-bolt	22
Connecting link-to-bracket	22	Steering gear-to-subframe mounting bolts (3-Series)	41
Connecting link bracket-to-control arm	41	Steering box-to-front suspension subframe bolts (5-Series)	42
Anti-roll bar (5-Series)		Track rod end-to-steering arm nut	37
Anti-roll bar mounting brackets	22	Track rod end clamping bolt	14
Anti-roll bar link-to-strut housing locknut		Pitman arm-to-steering box (5-Series)	140
Yellow chrome	20	Steering linkage balljoints (all)	37
White chrome	33		
Yellow	58		

1 General information



Warning: Whenever any of the suspension or steering fasteners are loosened or removed, they must be inspected and if

necessary, new ones fitted, of the same part number or of original-equipment quality and design. Torque specifications must be followed for proper reassembly and component retention. Never attempt to heat, straighten or weld any suspension or steering component. Any bent or damaged parts must be renewed.

The front suspension (see illustrations) is a MacPherson strut design. The struts are secured at the upper ends to reinforced areas at the top of the wheel arches, and at the lower ends to the steering arms/control arms. An anti-roll bar is attached to the control arms via connecting links, and to the suspension subframe (3-Series models) or the underbody (5-Series models).

The independent rear suspension system on 3-Series models (see illustration) features coil springs and telescopic shock absorbers. The upper ends of the shock absorbers are attached to the body; the lower ends are connected to trailing arms. An anti-roll bar is attached to the trailing arms via links, and to the body with clamps.

The independent rear suspension system on 5-Series models (see illustration) uses coil-

over shock absorber units instead of separate shock absorbers and coil springs. The upper ends are attached to the body; the lower ends are connected to the trailing arms. The rear suspension of 5-Series models is otherwise similar to that of 3-Series models: two trailing arms connected by an anti-roll bar.

The steering system consists of the steering wheel, a steering column, a universal joint shaft, the steering gear, the power

steering pump (where fitted) and the steering linkage, which connects the steering gear to the steering arms. On 3-Series models, a rack-and-pinion steering gear is attached directly to the steering arms via the track rods and track rod ends. On 5-Series models, a recirculating-ball steering box is connected to the steering arms via a Pitman arm, a centre track rod, the outer track rods and the track rod ends.

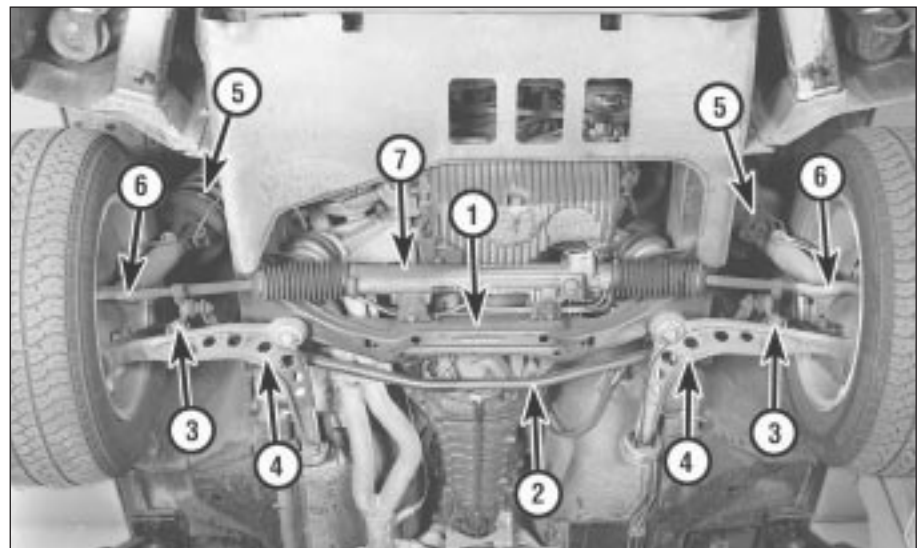

1.1a Front suspension and steering components (3-Series models)

- | | | | |
|-----------------|----------------------|-----------------|-----------------|
| 1 Subframe | 3 Anti-roll bar link | 5 Strut | 7 Steering gear |
| 2 Anti-roll bar | 4 Control arm | 6 Track rod end | |

1.1b Front suspension and steering components (5-Series models - left-hand-drive shown)

- 1 Subframe
- 2 Anti-roll bar
- 3 Anti-roll bar link
- 4 Centre track rod
- 5 Outer track rod
- 6 Track rod end
- 7 Steering arm
- 8 Control arm
- 9 Thrust arm
- 10 Strut

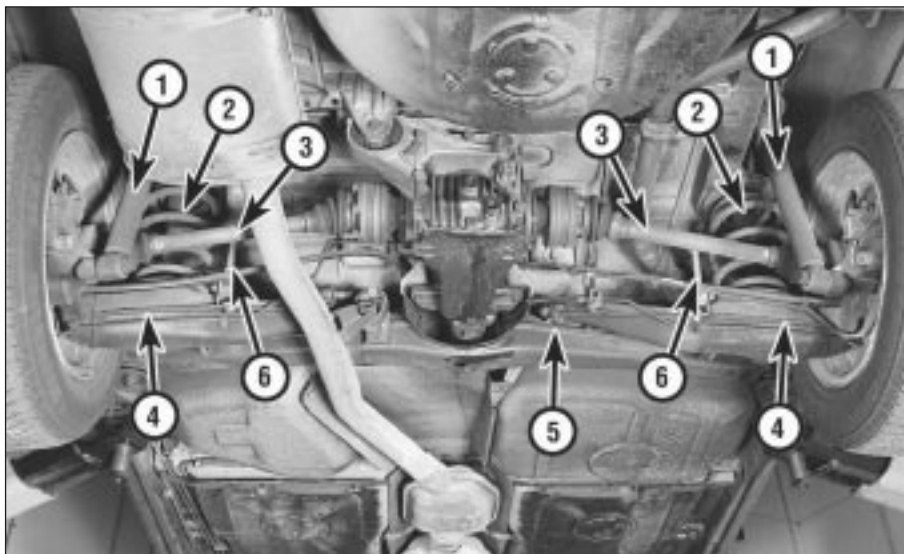
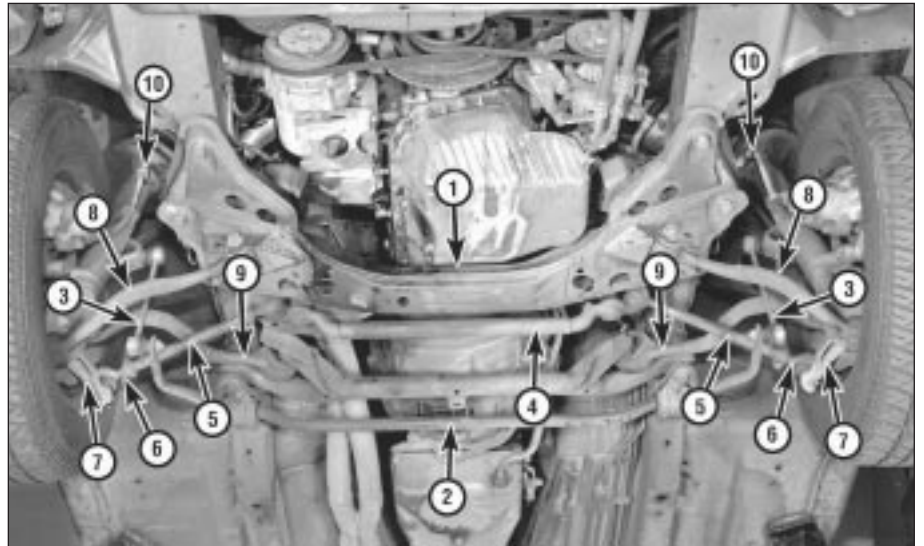

1.2 Rear suspension components (3-Series models)

- 1 Shock absorber
- 2 Coil spring
- 3 Driveshaft
- 4 Trailing arm
- 5 Rear axle carrier
- 6 Anti-roll bar link

1.3 Rear suspension components (5-Series models - left-hand-drive shown)

- 1 Shock absorber/coil spring assembly
- 2 Driveshaft
- 3 Anti-roll bar link
- 4 Anti-roll bar
- 5 Trailing arm
- 6 Rear axle carrier

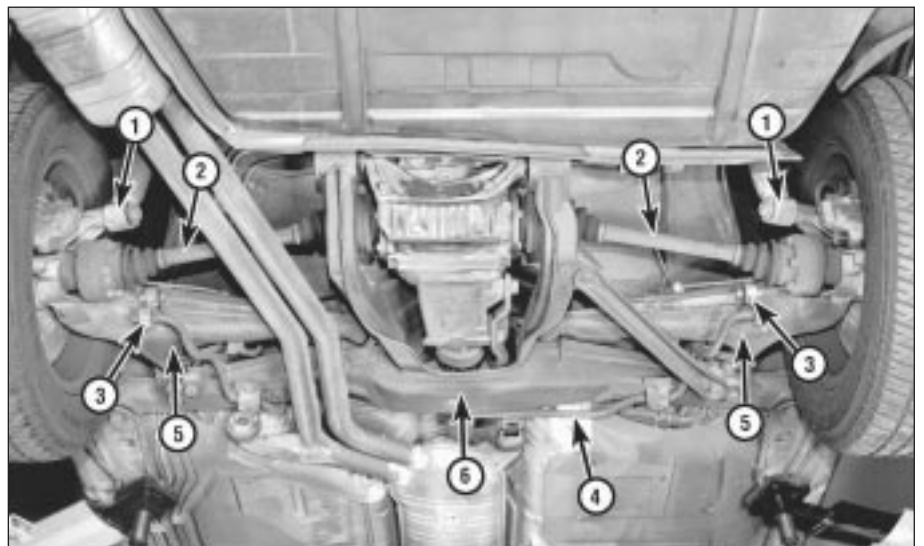



2.2a On 3-Series models, remove the nut (upper arrow) securing the anti-roll bar to the upper end of the connecting link (left side shown, right side similar). If a new control arm is being fitted, remove the lower nut (lower arrow) and disconnect the link assembly and bracket from the arm

2 Front anti-roll bar - removal and refitting



Removal

- 1 Raise the front of the vehicle, and support it securely on axle stands.
- 2 If you're removing or renewing the anti-roll bar itself, or disconnecting the bar to renew the strut assembly on a 3-Series model, disconnect it from the anti-roll bar links (see illustrations). If you're renewing the strut assembly on a 5-Series model, disconnect the anti-roll bar link from the strut housing.
- 3 On 3-Series models, disconnect the left control arm rubber bush from the underbody (see Section 3).
- 4 Remove the bolts from the anti-roll bar brackets which attach the anti-roll bar to the subframe (see illustration).
- 5 Remove the anti-roll bar from the vehicle. Where necessary, separate the anti-roll bar from the strut bar bracket.

Refitting

6 Refitting is the reverse of the removal procedure. Be sure to tighten all nuts and bolts to the torques listed in this Chapter's Specifications.



3.4 Remove the two bolts (arrowed) securing the bush bracket to the underbody



2.2b On 5-Series models, remove the nut (arrowed) securing the anti-roll bar to the connecting link (left side shown, right side similar)

3 Control arm (3-Series) - inspection, removal and refitting, and bush renewal



Inspection

- 1 Raise the front end of the vehicle, and support it securely on axle stands.
- 2 Grip the top and bottom of each balljoint with a large pair of water pump ("parrot jaw") pliers, and squeeze to check for free play. Alternatively, insert a lever or large screwdriver between the control arm and the subframe or strut housing. If there's any free play, renew the control arm (the balljoints can't be renewed separately).
- 3 Inspect the rubber bush. If it's cracked, dry, torn or otherwise deteriorated, renew it (see below).

Bush renewal

Note: Rubber bushes should always be renewed in pairs. Make sure both new bushes have the same markings (indicating they're manufactured by the same firm).

- 4 Remove the two bolts (see illustration) which attach the bush bracket to the underbody.
- 5 Using a puller, remove the bracket and



3.12 Remove the self-locking nut from the balljoint stud protruding through the top of the subframe (not shown in this photo, but it's directly above the balljoint) and separate the balljoint from the subframe. Try not to damage the dust boot



2.4 Remove the bolts (arrowed) from the anti-roll bar brackets to detach the anti-roll bar from the subframe (3-Series model shown, 5-series similar)

bush from the end of the control arm. If the puller slips on the end of the control arm, centre-punch the control arm to give the puller bolt a place to seat.

6 Note the orientation of the old bush. This is exactly how the new bush should be orientated when it's fitted. Press the old rubber bush out of the bracket, or have it pressed out by an engineering works.

7 Coat the end of the control arm with BMW's special lubricant (Part No. 81 22 9 407 284), and press the new bush and bracket onto the arm - or have it pressed on at an engineering works - all the way to the stop.



Caution: Don't try to use any other type of lubricant; 30 minutes after it's applied, this lubricant loses its properties and the bush is permanently located in its proper position. Make sure the new bush is pressed on so it's orientated exactly the same way as the old bush.

8 Refit the bracket bolts and tighten them to the torque listed in this Chapter's Specifications.

9 Lower the vehicle, and leave it at rest for at least 30 minutes (this will give the special lubricant time to dry).

Control arm removal and refitting

Note: If either balljoint is worn or damaged, the only way to renew it is to renew the control arm. If you're fitting a new control arm, a new bush must also be fitted. The old bush can't be removed from the old control arm and re-used in the new control arm.

10 Loosen but do not remove the wheel bolts, raise the front of the vehicle and support it on axle stands. Remove the wheel bolts and the front wheel.

11 Remove the two bolts which attach the rubber bush bracket to the underbody (see illustration 3.4).

12 Remove the nut which secures the control arm balljoint to the subframe, and remove the balljoint stud from the subframe. **Note:** It may be necessary to use a balljoint separator to separate the balljoint from the subframe (see illustration), but take care not to damage the



3.13a Remove the self-locking nut from the balljoint stud which attaches the outer end of the control arm to the steering knuckle. If you don't have a balljoint separator tool . . .

dust boot. If the boot does become damaged (and you're refitting the same control arm and balljoint), be sure to fit a new boot.

13 Unscrew the nut which secures the outer control arm balljoint to the steering knuckle (see illustration) and detach the balljoint stud from the knuckle (see illustration). Ideally you should use a purpose-made balljoint separator tool for this job. Using a hammer is OK if you're going to fit new parts anyway, but is not recommended if you're planning to re-use parts.

14 Remove the control arm.



4.5 If you're removing the control arm, remove the three bolts (arrowed) from the steering arm, and separate the strut assembly from the arm



4.6b If you're removing the thrust arm, remove the nut and bolt (arrowed) that secure the rear end of the arm



3.13b . . . give the steering knuckle a few sharp knocks with a hammer to release the balljoint stud from the strut housing, and remove the control arm

15 If you're renewing the control arm, you'll have to fit a new bush (see above). The old bush can't be removed re-used in another control arm.

16 Refitting is the reverse of removal. Be sure to use new self-locking nuts on the balljoint studs and tighten them, and the bush bracket bolts, to the torques listed in this Chapter's Specifications.

17 When you're finished, have the front wheel alignment checked by a dealer service department or qualified garage.



4.6a If you're removing the control arm, remove the self-locking nut and the through-bolt (arrowed) that attach the inner end of the arm to the vehicle



4.7a Remove the self-locking nut (control arm nut, left arrow; thrust arm nut, right arrow) from the balljoint, then support the steering arm, and press or knock the balljoint out of the steering arm

4 Control and thrust arms (5-Series) - inspection, removal and refitting and bush renewal



Inspection

1 Inspect the thrust arm rubber bush (see illustration 4.6b). If the bush is cracked, torn or otherwise deteriorated, renew it. The control arm bush can't be inspected until the control arm is removed.

2 Raise the vehicle and place it securely on axle stands.

3 To inspect the control arm and thrust arm balljoints for wear, grip the top and bottom of each balljoint with a large pair of water pump ("parrot jaw") pliers, and try to squeeze them. Alternatively, use a lever or large screwdriver to move them up and down. If there's any free play, renew the control arm or thrust arm. The balljoints can't be renewed separately.

Removal

Note: *If a balljoint is worn or damaged, the only way to renew it is to renew the control arm or thrust arm. If you're fitting a new control arm or thrust arm, a new bush must also be fitted. The old bush can't be removed from the old control arm or thrust arm and re-used in the new arm.*

4 Loosen the wheel bolts, raise the vehicle and support it securely on axle stands. Remove the wheel.

5 If you're removing the control arm, remove the three bolts from the steering arm (see illustration) and separate the strut assembly from the arm.

6 Remove the nut and the through-bolt that secure the control arm or thrust arm rear mounting (see illustrations).

7 Remove the nut from the balljoint (see illustration). Support the steering arm and separate the balljoint from the steering arm (see illustrations). Ideally you should use a purpose-made balljoint separator tool for this job. Using a hammer is OK if you're going to fit new parts anyway, but is not recommended if you're planning to re-use parts.



4.7b You can separate the thrust arm balljoint from the steering arm with a puller . . .

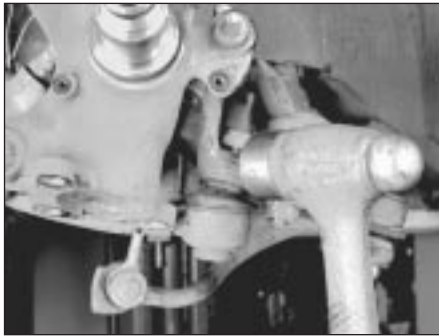

4.7c . . . but you may have to use a hammer to knock the control arm balljoint stud loose from the steering arm, because there's no room to use a puller. A purpose-made balljoint separator tool would be better

Bush inspection and renewal

8 If the bush is cracked, torn or otherwise deteriorated, take the arm to a BMW dealer service department or an engineering works, and have it pressed out and a new bush pressed in. Bushes should always be renewed in pairs (a new bush should be fitted in each arm, and both bushes should have the same manufacturer markings). If you're fitting a new thrust arm bush, make sure it's correctly orientated (see illustration).

Refitting

9 Refitting is the reverse of removal. Be sure to use new self-locking nuts on the balljoint stud nut and the through-bolt. Don't forget to refit the washers on both sides of the through-bolt. If you're refitting the control arm, be sure to use thread-locking compound on the steering arm mounting bolts. Don't tighten the through-bolt to the final torque yet. **Note:** *Thrust arms are marked "L" for the left side, and "R" for the right side. Be sure to check the marking before fitting a new arm.*

10 Support the control arm with a trolley jack, and raise it to simulate normal ride height, then tighten the through-bolt to the torque listed in this Chapter's Specifications.

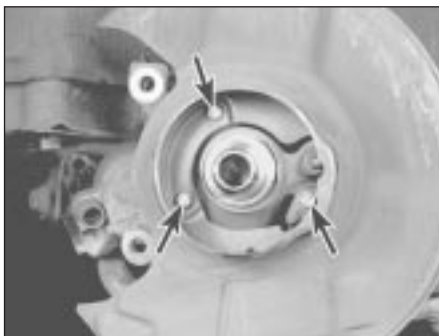

5.8 To remove the brake splash shield, remove these three bolts (arrowed)

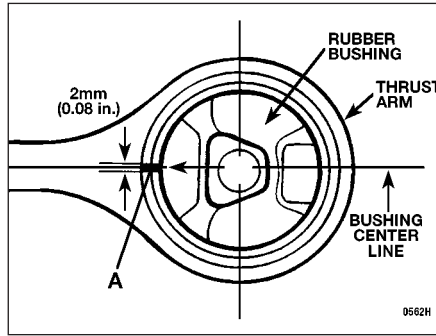

4.8 Correct orientation of the bush for the 5-Series thrust arm. The arrow on the rubber bush is aligned with the mark on the arm, and the centre of the bush is concentric with the bore

Refit the wheel and tighten the wheel bolts to the torque listed in the Chapter 1 Specifications.

11 Have the front end alignment checked at a dealer service department or qualified garage.

5 Front strut assembly - removal and refitting



Removal

Note: *Although strut assemblies don't always fail or wear out simultaneously, renew both left and right struts at the same time, to prevent handling peculiarities or abnormal ride quality.*

- 1 Loosen but do not remove the front wheel bolts.
- 2 Raise the front of the vehicle and support it on axle stands.
- 3 Remove the front wheel.
- 4 Detach all brake hoses and electrical wires attached to the strut housing.
- 5 Disconnect the electrical connections for the ABS system, if applicable.
- 6 If you're removing the left strut, disconnect



5.13 Support the weight of the strut and remove the three mounting nuts (arrowed) at the top of the strut (5-Series shown, 3-Series similar)

the electrical connector for the brake pad wear sensor.

7 Remove the bolt securing the ABS wheel sensor, if applicable. Remove the brake disc (see Chapter 9).

8 Remove the brake splash shield (see illustration).

9 On 3-Series models, disconnect the anti-roll bar from its connecting link (see Section 2). On 5-Series models, disconnect the anti-roll bar link from the strut housing (see Section 2).

10 On 3-Series models, disconnect the control arm balljoint from the steering knuckle (see Section 3) and the track rod end from the steering arm (see Section 17).

11 On 5-Series models, disconnect the bolts that attach the steering arm to the strut housing (see illustration 4.5).

12 Pull out the lower end of the strut housing far enough to clear the end of the control arm (3-Series) or the steering arm (5-Series).

13 Support the weight of the strut and remove the three mounting nuts at the top of the strut, located inside the engine compartment (see illustration) and remove the strut.

14 Remove the strut assembly. If a new shock absorber (strut cartridge) is being fitted, see Section 6.

Refitting

15 Refitting is the reverse of removal. On 3-Series models, be sure to use new self-locking nuts on the control arm balljoint, the track rod end balljoint and the strut upper mountings. On 5-Series models, make sure the tang in the steering arm is mated with the notch in the strut housing (see illustration). BMW recommends using a thread-locking compound on the steering arm mounting bolts. On all models, tighten the fasteners to the torques listed in this Chapter's Specifications.

16 When you're done, drive the vehicle to a dealer service department or qualified garage and have the wheel alignment checked, and if necessary, adjusted.

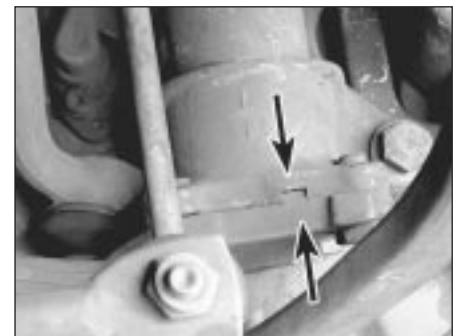

5.15 On 5-Series models, make sure the tang in the steering arm is mated with the notch in the strut housing (arrowed)

6 Strut or shock absorber/coil spring - renewal



Note: This section applies to all front strut assemblies and, on 5-Series models, the rear coil-over shock absorber assemblies.

1 If the struts, shock absorbers or coil springs exhibit the telltale signs of wear (leaking fluid, loss of damping capability, chipped, sagging or cracked coil springs) explore all options before beginning any work. Strut or shock absorber assemblies complete with springs may be available on an exchange basis, which eliminates much time and work. Whichever route you choose to take, check on the cost and availability of parts before dismantling the vehicle.



Warning: Dismantling a strut or coil-over shock absorber assembly is a potentially dangerous undertaking, and utmost attention must be directed to the job, or serious injury may result. Use only a high-quality spring compressor, and carefully follow the manufacturer's instructions supplied with the tool. After removing the coil spring from the strut assembly, set it aside in a safe, isolated area.

2 Remove the strut or shock absorber assembly (see Section 5 or 11). Mount the assembly in a vice. Line the vice jaws with wood or rags to prevent damage to the unit, and don't tighten the vice excessively.

3 Following the tool manufacturer's instructions, fit the spring compressor (these can be obtained at most car accessory shops, or it may be possible to hire one) on the spring, and compress it sufficiently to relieve all pressure from the suspension support (see illustration). This can be verified by wiggling the spring.

4 Prise the protective cap off the damper rod self-locking nut. Loosen the nut (see illustration) with a spanner while holding the

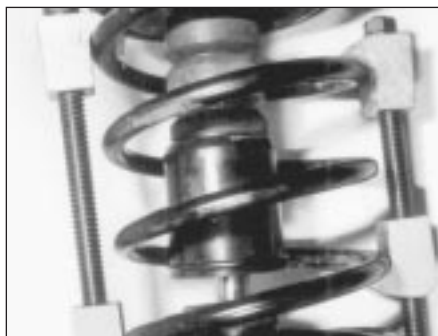

6.3 Following the tool manufacturer's instructions, fit the spring compressor to the spring, and compress it sufficiently to relieve all pressure from the suspension support

damper rod stationary with another spanner or an Allen key.

5 Remove the nut, the strut bearing, the insulator and the large washer. Check the bearing for smooth operation. If it doesn't turn smoothly, renew it. Check the rubber insulator for cracking and general deterioration. If there is any separation of the rubber, renew the insulator.

6 Lift off the spring retainer and the rubber ring at the top of the spring. Check the rubber ring for cracking and hardness. Renew it if necessary.

7 Carefully lift the compressed spring from the assembly and set it in a safe place, such as a steel cabinet.



Warning: Never place your head near the end of the spring!

8 Slide the protective tube and rubber bumper off the damper rod. If either is damaged or worn, renew it.

9 If you're working on a front strut, loosen and remove the threaded collar (see illustration) and pull the old strut cartridge from the strut housing.

10 On all struts except gas-charged units, fill the strut housing with 20 to 25 cc (3-Series), 42 to 47 cc (518i and 520i 5-Series models) or 20 to 25 cc (all other 5-Series models) of



6.4 Prise the protective cap off the damper rod nut, and remove the large nut (arrowed) - to prevent the damper rod from turning, place an Allen key in the end of the shaft

engine oil (the oil helps cool the shock absorber by transferring heat to the strut housing). **Note:** It doesn't matter what viscosity or grade of engine oil is used.

11 Refitting is otherwise the reverse of removal. Tighten the threaded collar to the torque listed in this Chapter's Specifications. Make sure you align the end of the coil spring with the shoulder of the rubber ring and with the spring retainer (see illustration). Tighten the damper rod nut to the torque listed in this Chapter's Specifications.

12 Refit the strut or shock absorber assembly (see Section 5 or 11).

7 Balljoints - check and renewal



Check

Note: On 3-Series models, there are two balljoints on each control arm - one between the middle of the arm and the subframe, and the other between the outer end of the arm and the steering knuckle. On 5-Series models, there are balljoints on the outer ends of the control arm and the thrust arm.

1 Raise the vehicle and support it securely on axle stands.

2 Visually inspect the rubber boot between the balljoint and the subframe or steering knuckle, etc for cuts, tears or leaking grease. If you note any of these conditions, renew the control arm or thrust arm - the balljoints are not available separately.

3 Place a large lever under the balljoint, and try to push the balljoint up. Next, position the lever between the arm and the subframe or between the arm and steering knuckle. If you can see or feel any movement during either check, a worn balljoint is indicated.

4 Have an assistant grasp the tyre at the top and bottom, and shake the top of the tyre with an in-and-out motion. Touch the balljoint stud nut. If any looseness is felt, suspect a worn balljoint stud or a widened hole in the subframe or steering knuckle. If the latter



6.9 Loosen and remove the threaded collar, and pull the old strut cartridge from the strut housing - on all struts except gas-charged units, pour the old oil from the strut housing. (Spring should have been removed first)



6.11 Make sure you align the end of the coil spring with the shoulder of the rubber ring, and with the spring retainer



8.2 Using a hammer and chisel, knock out the dust cap in the centre of the hub



8.3 Using a chisel, knock out the staked portion of the hub nut



8.8a If the hub sticks, knock it loose with a hammer

problem exists, a new subframe or steering arm (5-Series) or steering knuckle (3-Series), which is integral with the strut housing, should be fitted as well as the new balljoint.

Renewal

Note: None of these balljoints can be serviced or renewed individually. If one of them is worn, a complete new arm must be fitted.

8 Front hub and wheel bearing assembly - removal and refitting



Note: Removing the front hub/bearing assembly renders it unfit for re-use. A new assembly will be required for refitting.

Removal

- 1 Loosen the wheel bolts, then raise the front of the vehicle, and support it securely on axle stands. Remove the wheel bolts and the wheel.
- 2 Using a hammer and chisel, remove the dust cap from the centre of the wheel hub (see illustration).
- 3 Unstake the hub nut (see illustration).
- 4 Refit the wheel and lower the vehicle to the ground. Loosen, but do not remove, the hub nut.



Warning: Always loosen and tighten the hub nut with the vehicle on the ground. The

leverage needed to loosen the nut (which is very tight) could topple the vehicle off a lift or an axle stand.

- 5 Raise the front of the vehicle, support it securely on axle stands, and remove the front wheel again.
- 6 Remove the front brake caliper and mounting bracket (see Chapter 9). There is no need to disconnect the brake hose. Hang the caliper out of the way with a piece of wire.
- 7 Remove the brake disc (see Chapter 9).
- 8 Remove the hub nut, and pull the hub and bearing assembly off the stub axle. You may have to tap it off if it's stuck (see illustration). If the inner race of the bearing remains on the stub axle (it probably will), remove the dust shield (rubber boot) behind the bearing, and use a puller to remove the inner race (see illustration).

Refitting

- 9 Fit a new dust shield.
- 10 Push the new hub and bearing onto the stub axle. If it's necessary to use force, press or drive only against the bearing inner race (see illustration).
- 11 Fit a new hub nut, and tighten it finger-tight at this stage.
- 12 Refit the brake disc, its countersunk retaining screw, and the brake caliper (see Chapter 9).
- 13 Refit the wheel, and lower the vehicle to the ground.
- 14 Tighten the hub nut to the torque listed in

this Chapter's Specifications. Again, make sure you do this with the vehicle on the ground, not up on axle stands.

- 15 Raise the front of the vehicle and place it securely on axle stands. Remove the wheel.
- 16 Stake the collar of the nut into the groove of the spindle.
- 17 Apply suitable sealant to a new grease cap, and fit the cap by driving it into place with a soft-faced mallet.
- 18 Refit the wheel and wheel bolts. Lower the vehicle to the ground, and tighten the wheel bolts to the torque listed in the Chapter 1 Specifications.

9 Rear shock absorbers (3-Series) - removal and refitting



Removal

Note: Although shock absorbers don't always wear out simultaneously, renew both left and right shock absorbers at the same time, to prevent handling peculiarities or abnormal ride quality.

- 1 Chock the front wheels.
- 2 Raise the rear of the vehicle, and support it securely on axle stands. Support the trailing arm with a trolley jack. Place a block of wood on the jack head to serve as a cushion.
- 3 Remove the shock absorber lower mounting bolt (see illustration).



8.8b If the inner race of the bearing sticks to the stub axle, use a puller to get it off



8.10 Use a large socket or a suitable piece of pipe to drive against the inner race of the new bearing

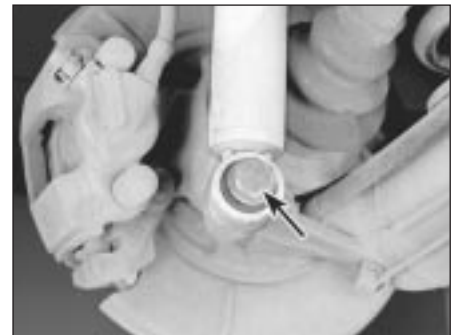

9.3 Remove the shock absorber lower mounting bolt (arrowed)

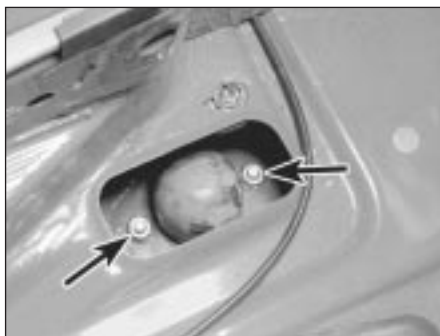

9.4 Shock absorber upper mounting nuts (arrowed) - late-model convertible shown.

On other early models, upper nuts are accessible from the luggage compartment; on later models, they're behind the back of the rear seat, up under the parcel shelf

4 On some models, working inside the boot, you can remove the trim to access the upper mounting nuts; on later models, you'll have to remove the rear seat back to get at the upper mounting nuts. On Touring (Estate) models, remove the side backrest and rear seat belt reels, and unscrew the centring shell on the wheel arch. On Convertibles, simply remove the top from the recessed well behind the passenger compartment, and remove the small rubber access cover. As you remove the mounting nuts (see illustration), have an assistant support the shock absorber from below so it doesn't fall out.

5 Look for oil leaking past the seal in the top of the shock absorber body. Inspect the rubber bushings in the shock absorber eye. If they're cracked, dried or torn, renew them. To test the shock absorber, grasp the shock absorber body firmly with one hand, and push the damper rod in and out with the other. The strokes should be smooth and firm. If the rod goes in and out too easily, or unevenly, the shock absorber is defective and must be renewed.

Refitting

6 Fit the shock absorbers in the reverse order of removal, but don't tighten the mounting bolts and nuts yet.

7 Bounce the rear of the vehicle a couple of times to settle the bushings, then tighten the nuts and bolts to the torque values listed in this Chapter's Specifications.

10 Rear coil springs (3-Series) - removal and refitting



Note: Although coil springs don't always wear out simultaneously, renew both left and right springs at the same time, to prevent handling peculiarities or abnormal ride quality.

Removal

1 Loosen the wheel bolts. Chock the front wheels, then raise the rear of the vehicle and



11.2 Remove the shock absorber lower mounting bolt (arrowed)

support it securely on axle stands. Make sure the stands don't interfere with the rear suspension when it's lowered and raised during this procedure. Remove the wheels.

2 Disconnect the mountings and brackets which support the rear portion of the exhaust system, and temporarily lower the exhaust system only enough to lower the suspension and remove the springs. Suspend the exhaust with a piece of wire.

3 Support the differential with a trolley jack, then remove the differential rear mounting bolt. Push the differential down, and wedge it into this lowered position with a block of wood. This reduces the drive angle, preventing damage to the CV joints when the trailing arms are lowered to remove the springs.

4 Place a trolley jack under the trailing arm.

5 If the vehicle has a rear anti-roll bar, disconnect the bar from its connecting links, or disconnect the links from the trailing arms (see Section 12).

6 Loop a chain through the coil spring, and bolt the chain together, to prevent the coil spring from popping out when the trailing arm is lowered. Be sure to leave enough slack in the chain to allow the spring to extend completely.

7 Disconnect the shock absorber lower mounting bolt (see Section 9), carefully lower the trailing arm and remove the coil spring.

Refitting

8 Refitting is the reverse of removal. As the trailing arm is raised back up, make sure the spring seats properly.

11 Rear shock absorber/coil spring assembly (5-Series) - removal and refitting



Removal

Note: Although shock absorbers don't always wear out simultaneously, renew both left and right shock absorbers at the same time, to prevent handling peculiarities or abnormal ride quality.

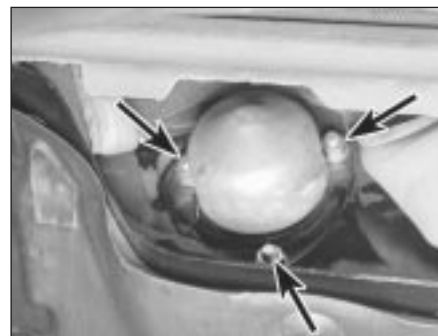

11.3 Shock absorber upper mounting nuts (arrowed) on a later (E34) 5-Series model

1 Loosen the wheel bolts, then chock the front wheels. Raise the vehicle and support it securely on axle stands. Remove the wheels.

2 Remove the shock absorber lower mounting bolt (see illustration).

3 On early models, peel back the trim inside the luggage compartment far enough to access the upper mounting nuts. To get at the upper mounting nuts on later models, first remove the rear seat cushion (see Chapter 11), then remove the two bolts holding the rear seat backrest, and remove the backrest. Support the trailing arm with a jack, and remove the upper mounting nuts (see illustration). Lower the jack, and remove the shock absorber and the gasket. To separate the shock absorber and spring, refer to Section 6.

Refitting

4 Refitting is the reverse of removal. Don't forget to fit the gasket between the upper end of the shock absorber and the body. Tighten the upper nuts to the torque listed in this Chapter's Specifications. Don't tighten the lower bolt until the vehicle is lowered.

5 Lower the vehicle, and with it sitting at the normal ride height, tighten the lower bolt to the torque listed in this Chapter's Specifications.

12 Rear anti-roll bar - removal and refitting



Removal

Note: The rear anti-roll bar is mounted basically the same way on all models. Follow these general removal and refitting procedures, keeping in mind any variations.

1 Chock the front wheels, then raise the rear of the vehicle and support it securely on axle stands.

2 Remove the anti-roll bar bracket bolts or nuts (see illustration).

3 Disconnect the anti-roll bar from the link at each end of the bar (see illustrations) and detach the anti-roll bar.



12.2 Rear anti-roll bar bracket bolt (arrowed) (3-Series)

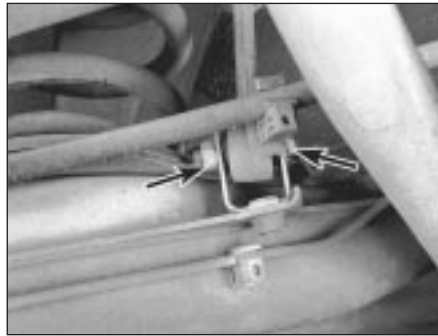

12.3a A nut and bolt (arrowed) connect each rear anti-roll bar link to the rear trailing arms (3-Series)

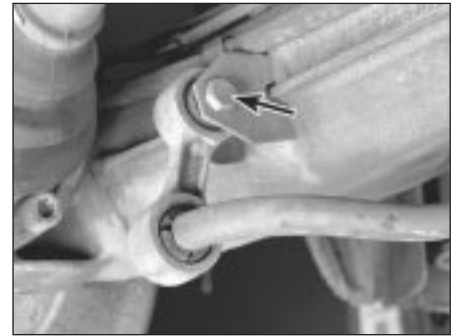

12.3b Bolt (arrowed) connecting rear anti-roll bar link to trailing arm (5-Series)

4 Inspect and, if necessary, renew any worn or defective bolts, washers, bushes or links.

Refitting

5 Refitting is the reverse of removal. Tighten all fasteners securely.

13 Rear trailing arms (3-Series) - removal and refitting



Removal

1 Loosen the wheel bolts, then chock the front wheels. Raise the rear of the vehicle, and support it securely on axle stands. Remove the wheel(s).

2 Remove the driveshaft (see Chapter 8), or disconnect it from the final drive output flange.

3 Disconnect the rear brake hose from the metal brake line at the bracket on the trailing arm (see illustration). **Note:** For information on disconnecting brake hose-to-metal line connections, see Chapter 9. Plug the line and hose, to prevent dirt ingress and loss of brake fluid.

4 Disconnect the handbrake cable (see Chapter 9).

5 Disconnect the lower end of the shock

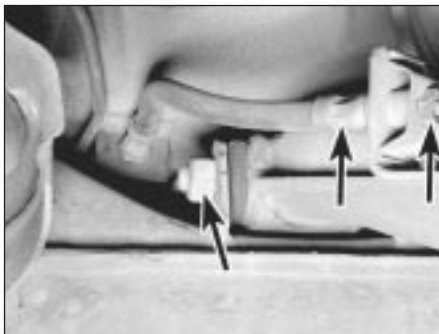

13.3 Disconnect the rear brake hose (middle arrow) from the metal brake line fitting (right arrow) at this bracket on the trailing arm, then plug the line and hose immediately; the other arrow points to the nut for the inner pivot bolt

absorber from the trailing arm (see Section 9), and lower the trailing arm.

6 Remove the trailing arm pivot bolts (see illustration) and remove the trailing arm.

7 Inspect the pivot bolt bushes. If they're cracked, dried out or torn, take the trailing arm to an engineering works and have them new ones fitted. Each bush has a larger diameter shoulder on one end. Make sure this larger diameter shoulder on each bush faces away from the trailing arm, ie the inner bush shoulder faces the centre of the vehicle, and the outer bush shoulder faces away from the vehicle.

Refitting

8 Refitting is the reverse of removal. Support the trailing arm with a trolley jack, and raise it to simulate normal ride height, then tighten the nuts and bolts to the torque listed in this Chapter's Specifications. Be sure to bleed the brakes as described in Chapter 9.

14 Rear trailing arms (5-Series) - removal and refitting



Removal

1 Loosen the wheel bolts, then chock the front wheels. Raise the rear of the vehicle and support it securely on axle stands. Remove the wheel(s).



13.6 Nut (arrowed) for the outer pivot bolt

2 Remove the driveshaft (see Chapter 8).

3 Disconnect the rear brake hose from the metal brake line at the bracket on the trailing arm (see illustration). **Note:** For information on disconnecting brake hose-to-metal line connections, see Chapter 9. Plug the line and hose, to prevent dirt ingress and loss of brake fluid.

4 Disconnect the handbrake cable from the handbrake actuator, and unclip the handbrake cable from the trailing arm (see Chapter 9).

5 Remove the ABS wheel sensor (if applicable) from the trailing arm, and unclip the sensor wire harness from the arm. Position the sensor aside so it won't be damaged during removal of the trailing arm.

6 If you're removing the right trailing arm, unplug the connector for the brake pad wear sensor, if applicable.

7 Disconnect the rear anti-roll bar from the trailing arm (see Section 12).

8 On 1983 and later models, remove one of the rear axle carrier bolts (see illustration).

9 Disconnect the shock absorber lower mounting bolt (see Section 11).

10 Remove the two trailing arm pivot bolts and nuts, and remove the trailing arm from the vehicle.

11 Inspect the pivot bolt bushes. If they're cracked, dried out or torn, take the trailing arm to an engineering works, and have new ones fitted. The bush inner sleeve is longer on one side. Make sure the bushes are fitted with

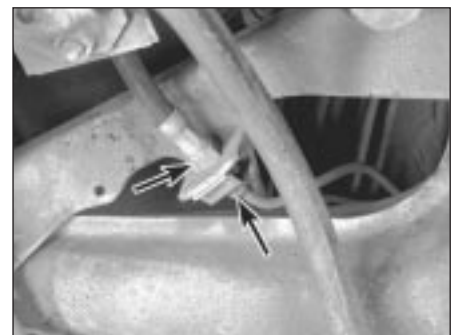

14.3 Disconnect the brake hose (left arrow) from the fitting on the metal brake line (right arrow) at this bracket



14.8 On 1983 and later models, remove one of these trailing arm-to-axle carrier bolts (it doesn't matter which one you remove - one attaches the link to the trailing arm, and the other attaches the link to the axle carrier)

the longer side of the sleeve facing towards the centre of the vehicle.

Refitting

12 Refitting is the reverse of removal. Refit the inner pivot bolt first. Don't fully tighten the nuts on the pivot bolts or the shock absorber yet.

13 Bleed the brakes as described in Chapter 9.

14 Support the trailing arm with a trolley jack, and raise it to simulate normal ride height. Tighten the bolts and nuts to the torques listed in this Chapter's Specifications.

15 Rear wheel bearings - renewal



3-Series models

1 Loosen the driveshaft nut and the rear wheel bolts, then chock the front wheels. Raise the rear of the vehicle and place it securely on axle stands. Remove the rear wheel. **Note:** Depending on the type of rear wheel, it may be necessary to remove the wheel first, remove the hubcap, then refit the wheel and loosen the driveshaft nut.

2 Remove the driveshaft (see Chapter 8).



15.8 Lower the vehicle and loosen the drive flange nut

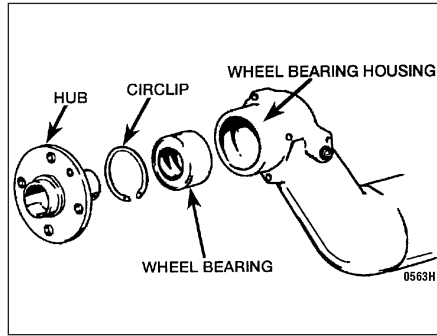

15.4 An exploded view of the 3-Series rear wheel bearing assembly

3 On models with rear brake drums, remove the drum. On models with rear disc brakes, remove the brake caliper and mounting bracket. Don't disconnect the hose. Hang the caliper out of the way with a piece of wire. Remove the brake disc (see Chapter 9). Working from behind, drive the wheel hub out of the wheel bearing with a large socket or a piece of pipe.

HAYNES HINT If the bearing inner race sticks to the hub (it probably will), use a puller to remove the race from the hub.

4 Remove the large circlip (see illustration) that holds the wheel bearing in the wheel bearing housing, then drive out the bearing with a large socket or piece of pipe.

5 Refitting is basically the reverse of removal, bearing in mind the following points:

- a) Be extremely careful where you place the socket or piece of pipe when you drive the new bearing into the housing. It should be butted up against the outer race of the bearing. Driving in the new bearing using the inner race will ruin the bearing.
- b) Refit the wheel and lower the vehicle to the ground before attempting to tighten the driveshaft nut to the torque listed in the Chapter 8 Specifications.



15.11 Remove the drive flange with a puller

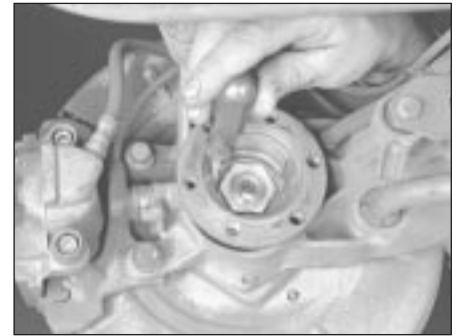

15.7 Prise out the lockplate that secures the drive flange nut - once you've prised out an edge of the lockplate, pull it out with a pair of needle-nose pliers

5-Series models

6 Chock the front wheels, then raise the rear of the vehicle and support it securely on axle stands. Disconnect the outer CV joint from the drive flange (see Chapter 8). Support the outer end of the driveshaft with a piece of wire - don't let it hang, as this could damage the inner CV joint.

7 Prise out the lockplate that secures the drive flange nut (see illustration). Once you've prised out an edge of the lockplate, pull it out with a pair of needle-nose pliers.

8 Lower the vehicle and unscrew the drive flange nut, but don't remove it yet. You'll need a long bar (see illustration).



Warning: Don't attempt to loosen this nut with the vehicle on axle stands. The force required to loosen the nut could topple the vehicle from the stands.

9 Loosen the rear wheel bolts, raise the rear of the vehicle again, place it securely on axle stands and remove the wheel.

10 Remove the brake caliper and the brake disc (see Chapter 9). Hang the caliper out of the way with a piece of wire.

11 Remove the drive flange nut. Using a suitable puller, remove the drive flange (see illustration).

12 Using a soft-faced hammer, drive the stub axle out of the bearing (see illustration). If the bearing inner race comes off with the stub

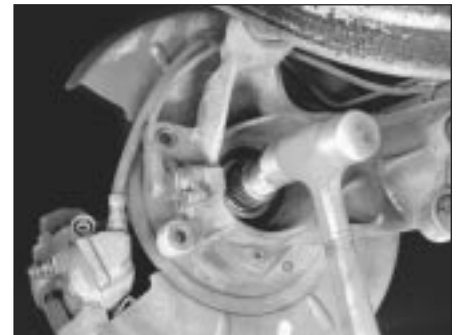

15.12 Using a soft-faced hammer, drive the stub axle out of the bearing



15.13a Remove the large circlip that retains the bearing in the housing . . .



15.13b . . . then drive the bearing out of the housing with a large socket or a suitable piece of pipe



15.14a To refit the new bearing, use a large socket or a piece of pipe with an outside diameter the same diameter as the outer race of the bearing - don't apply force to the inner race - and make sure the bearing is fully seated against the back of its bore

axle (it probably will), use a puller to remove the race from the stub axle. If you can't get the race off with a puller, take the stub axle to an engineering works and have it pressed off.

13 Remove the large circlip that retains the bearing in the bearing housing (see *illustration*), then drive the bearing out of the bearing housing with a large socket or a suitable piece of pipe (see *illustration*).

14 Refitting is basically a reversal of removal, bearing in mind the following points:

- a) Fit the new bearing using a large socket or a suitable piece of pipe, with an outside diameter the same diameter as the outer race (see *illustration*). Don't apply force to the inner race. Make sure the bearing is fully seated against the back of the bore. Refit the circlip, making sure it's fully seated into its groove.
- b) BMW dealers use special tools (Part Nos. 23 1 1300, 33 4 080 and 33 4 020) to pull the stub axle into the bearing, because the smooth portion between the splined portion of the stub axle and the flange is a press-fit, and knocks out the wheel bearing inner race during refitting of the stub axle. However, you can refit the stub axle without these tools, using the old inner race and a piece of pipe 13 mm long by 38 mm inside diameter (see

illustration). First, insert the stub axle through the new bearing until the threaded portion protrudes from the inner race. Refit the nut and tighten it until the splined portion of the stub axle shaft bottoms against the nut. You'll need to hold the stub axle flange with a lever or a large screwdriver while tightening the nut (see *illustration*). Tighten the nut again until it bottoms against the splines. Remove the nut, refit the old inner race, refit the nut and tighten it once more until it bottoms against the splines. Remove the nut, remove the old inner race, refit your piece of pipe, refit the old inner race, refit the nut and tighten it until it bottoms against the splines. Remove the nut, the old race and the pipe. Refit the drive flange, refit the nut and tighten it securely, but don't attempt to tighten it to the final torque until the vehicle is lowered to the ground.

- c) Refit the wheel and lower the vehicle to the ground before tightening the stub axle nut to the torque listed in this Chapter's Specifications.

15 The remainder of refitting is the reverse of removal.

16 Steering system - general information

On 3-Series models, the steering wheel and steering column are connected to a rack-and-pinion steering gear (power-assisted where applicable) via a short universal joint shaft. When the steering wheel is turned, the steering column and universal joint turn a pinion gear shaft on top of the rack. The pinion gear teeth mesh with the gear teeth of the rack, so the rack moves right or left in the housing when the pinion is turned. The movement of the rack is transmitted through the track rods and track rod ends to the steering arms, which are an integral part of the strut housings.

On 5-Series models, the upper part of the steering system is identical to a 3-Series. Instead of a rack-and-pinion set-up, however, these models use a power-assisted recirculating ball steering box which steers the front wheels via a steering linkage consisting of a Pitman arm, an idler arm, a centre track rod, a pair of inner track rods, and two track rod ends.



15.14b You can fabricate your own spacer tool from a piece of 13 mm long, 38 mm inside diameter pipe (left); you'll also need to use the old inner race (right)



15.14c Hold the stub axle flange with a large lever while tightening the nut



15.14d When you refit the spacer, make sure it's centred on the inner race of the bearing before tightening the nut



17.2 Loosen the nut on the track rod balljoint stud. For preference use a balljoint separator; otherwise, give the steering arm a few light blows with a hammer to release the balljoint stud. Remove the nut, and separate the balljoint stud from the steering arm



17.3 Loosen the clamp bolt (arrowed) that locks the track rod end to the inner track rod. Paint an alignment mark on the threads, to ensure the track rod end is refitted in the same position, and unscrew the track rod end from the inner track rod



17.6 Measure the length of the track rod and record your measurement, or paint an alignment mark on the threads to ensure the track rod end is refitted in the same position, then loosen the clamp bolt (arrowed)

Where power-assistance is fitted, hydraulic pressure (provided by an engine-driven pump) delivers power steering fluid to the rack-and-pinion steering gear or the recirculating-ball steering box - this enhances steering response and reduces steering effort.

Aside from maintaining the proper level of power steering fluid in the system and checking the tension of the drivebelt (see Chapter 1, where applicable), the steering system requires no maintenance. However, on high-mileage vehicles, the track rod end balljoints, the universal joints on either end of the universal joint shaft, and the rubber coupling between the steering column and the universal joint shaft will wear, develop excessive play, and cause the steering to feel somewhat loose. At this point, you'll have to renew these items; they can't be serviced.

Before you conclude that the steering system needs work, however, always check the tyres (see Section 25) and tyre pressures (see Chapter 1). Also inspect the bearings in the strut upper mounts (see Section 5), the front hub bearings (see Section 8) and other suspension parts, which may also be contributing to an imprecise steering feel.

17 Track rod ends - removal and refitting



1 Loosen but do not remove the wheel bolts, then raise the front of the vehicle and secure it on axle stands. Remove the front wheel.

3-Series models

2 Loosen the nut on the track rod balljoint stud, and free the balljoint stud from the steering arm using a balljoint separator. In the absence of a separator tool, try giving the steering arm a few light blows with a hammer (see illustration). Remove the nut, and separate the balljoint stud from the steering arm.

3 Loosen the clamp bolt that locks the track rod end to the inner track rod. Measure the length of the track rod end, or paint an alignment mark on the threads to ensure the track rod end is refitted in the same position (see illustration). Unscrew the track rod end from the inner track rod.

4 Refitting is the reverse of removal. Make sure the mark you made on the threads of the track rod end is aligned correctly, if applicable. If you measured the track rod end, make sure it is refitted to the same distance.

5 Have the toe-in checked and, if necessary, adjusted at a dealer service department or qualified garage.

5-Series models

6 Measure the length of the track rod and record your measurement, or paint an alignment mark on the threads to ensure the track rod end is refitted in the same position (see illustration). Loosen the clamp bolt.

7 Use a balljoint separator or a puller to separate the track rod end from the steering arm (see illustration).

8 Unscrew the track rod end.

9 Refitting is the reverse of removal. Make sure you align the paint mark made on the threads of the track rod end, if applicable. If you measured the track rod end, make sure it is refitted to the same distance.

10 Have the toe-in checked and, if necessary, adjusted at a dealer service department or qualified garage.

18 Steering gear boots (3-Series) - renewal



1 Remove the track rod ends (see Section 17).

2 Cut the boot clamps at both ends of the old boots, and slide off the boots.

3 While the boots are removed, inspect the seals in the end of the steering gear. If they're



17.7 Using a puller to separate the track rod end from the steering arm

leaking, renew the steering gear (see Section 19).

4 Slide the new boots into place and fit new boot clamps.

5 Refit the track rod ends (see Section 17).

19 Rack-and-pinion steering gear (3-Series) - removal and refitting



Removal

1 Loosen but do not remove the wheel bolts, raise the vehicle and support it securely on axle stands. Remove the front wheels.

2 Mark the lower universal joint on the steering shaft and the pinion shaft, to ensure proper alignment when they're reassembled. Remove the nut and bolt that attach the lower end of the universal joint shaft to the steering gear pinion shaft. Loosen the bolt and nut at the upper end of the universal joint shaft. Slide the universal joint shaft up a little, disengage it from the pinion shaft, and remove it. Inspect the universal joints and the rubber coupling for wear. If any of them are worn or defective, renew the universal joint shaft.

3 On power steering models, using a large

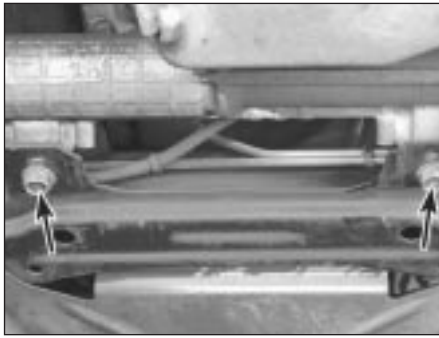

19.6 Rack-and-pinion steering gear mounting bolts (arrowed) - 3-Series models - (self-locking nuts not visible in this photo)

syringe or hand pump, empty the power steering fluid reservoir.

4 On power steering models, remove the banjo bolts and disconnect the power steering pressure and return lines from the steering gear. Place a container under the lines to catch spilled fluid. Plug the lines to prevent excessive fluid loss and contamination. Discard the sealing washers (new ones should be used when reassembling).

5 Disconnect the track rod ends from the steering arms (see Section 17).

6 Remove the nuts and bolts from the steering gear mounting brackets (see illustration). Discard the old nuts.

7 Withdraw the assembly from beneath the vehicle. Take care not to damage the steering gear boots.

Refitting

8 Refitting is the reverse of removal. Make sure the marks you made on the lower universal joint and the pinion shaft are aligned before you tighten the clamping bolts for the upper and lower universal joints. Use new self-locking nuts on the steering rack



20.4 To remove an outer track rod, remove this nut (arrowed) from the end of the centre track rod, and use a balljoint separator to separate the balljoint stud from the centre track rod (if you're renewing the inner track rod end, mark the threads with paint before loosening the clamp bolt and nut)

mounting bolts, and new sealing washers on the hydraulic line fittings. Tighten the mounting bolts, the track rod end nuts and the universal joint shaft clamping bolts to the torque values listed in this Chapter's Specifications.

9 Lower the vehicle to the ground.

10 On power steering models, fill the reservoir with the recommended fluid (see Chapter 1) and bleed the power steering system (see Section 23).

11 It's a good idea to have the front wheel alignment checked by a dealer service department or qualified garage.

20 Steering linkage (5-Series) - inspection, removal and refitting



Inspection

1 Raise the vehicle and place it securely on axle stands.

2 Firmly grasp each front tyre at the top and bottom, then at the front and rear, and check for play in the steering linkage by rocking the tyre back and forth. There should be little or no play in any of the linkage balljoints. Inspect the Pitman arm, the idler arm, the centre track rod, the inner track rods, the track rod ends and the steering arms for any obvious damage. Try forcing the linkage parts in opposite directions from one another. There should be no play between any of them. If any of the parts are bent or damaged in any way, or if any of the balljoints are worn, renew the parts concerned.

Removal

3 Before dismantling the steering linkage, obtain a suitable balljoint separator. A two-jaw puller or a wedge-type tool will work (although the wedge-type tends to tear the balljoint boots). Sometimes, you can also jar a balljoint taper pin free from its eye by striking opposite sides of the eye simultaneously with two large hammers, but the space available to do this is limited, and the balljoint stud sometimes



20.7 To unbolt the idler arm from the subframe crossmember, remove this nut (arrowed)

sticks to the eye because of rust and dirt. There is also a risk of damaging the component being struck.

4 To remove the outer track rods, disconnect the track rod ends from the steering arms (see Section 17). Remove the nut that attaches the balljoint on the inner end of each outer track rod to the centre track rod (see illustration). Using a balljoint separator, disconnect the outer track rods from the centre track rod. If you're renewing the balljoint at either end of the outer track rods, paint or scribe alignment marks on the threads to mark their respective positions as a guide to adjustment during reassembly (see illustration 17.3).

5 To remove the centre track rod, remove the nuts that attach the centre track rod balljoints to the Pitman arm and the idler arm, and use a balljoint separator to disconnect the balljoints from the two arms.

6 To remove the Pitman arm, you'll have to remove the steering box first (see Section 21). Look for match marks between the sector shaft and arm. If there aren't any, scribe a mark across the bottom face of both parts. Remove the Pitman arm pinch-bolt and nut, then remove the arm with a puller.

7 To unbolt the idler arm, first remove the small cover bolted to the top of the subframe crossmember. Put a spanner on the bolt, and remove the nut recessed into the underside of the subframe crossmember (see illustration). Check the idler arm rubber bush for wear. If it's damaged or worn, renew it.

8 Check each balljoint for excessive play or stiffness, and for split or deteriorated rubber dust boots. Renew all worn or damaged balljoints. The inner and outer track rod ends on the outer track rods can be renewed individually; if either balljoint on the centre track rod is damaged or worn, you must renew the centre track rod.

Refitting

9 Refitting is the reverse of the removal procedure, but observe the following points:

- Realign the match marks on the Pitman arm and the steering box sector shaft when reassembling them.
- If you're fitting new inner or outer track rod ends on the outer track rods, position them so that the match marks made during dismantling are aligned, and make sure they are equally spaced on each side.
- Position the track rod end balljoint studs on the outer track rods at an angle of 90° to each other.
- Make sure the left and right outer track rods are equal in length when they are fitted.
- Tighten all retaining bolts to the torque values listed in this Chapter's Specifications.
- When reassembly of the linkage is complete, have the front wheel alignment checked, and if necessary, adjusted.

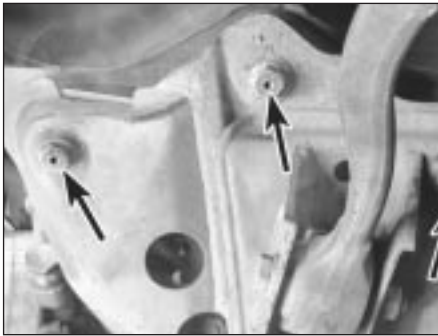

21.7 Subframe crossmember bolts (arrowed)



21.9 Disconnect the power steering pressure line fitting (right arrow) and the return line fitting (left arrow). Note that the return line fitting banjo bolt is larger than the bolt for the pressure line fitting (left-hand-drive shown)



21.10a This bolt (arrowed) secures the steering box to the subframe crossmember. The nut, not visible in this photo, is accessed through a hole in the crossmember (engine removed for clarity, left-hand-drive shown)

21 Steering box (5-Series) - removal and refitting



Removal

Note: If you find that the steering box is defective, it is not recommended that you overhaul it. Because of the special tools needed to do the job, it is best to let your dealer service department overhaul it for you (otherwise, fit a new unit). Removal and refitting the steering box is outlined here.

- 1 On 5-Series E28 ("old-shape") models, discharge the hydraulic system by depressing the brake pedal about 20 times.
- 2 Using a large syringe or hand pump, empty the power steering fluid reservoir (see Chapter 1).
- 3 Raise the front of the vehicle and support it securely on axle stands.
- 4 Support the front of the engine with a trolley jack. Place a block of wood between the jack head and the sump to protect the sump from damage.
- 5 Remove the pivot bolts from the inner ends of the front control arms (see Section 4).
- 6 Remove the nuts from the left and right engine mountings (see Chapter 2).
- 7 Remove the mounting bolts (two on each side on earlier models, three on each side on later models) from the subframe crossmember (see illustration) and remove the subframe.
- 8 Remove the nuts and bolts that secure the universal joint shaft to the steering box worm shaft. Slide the universal joint shaft up and off the worm shaft. Inspect the universal joint shaft for wear. If it's stiff or worn, renew it.
- 9 Remove the banjo bolts, and disconnect the hydraulic pressure line and the return line from the box (see illustration). Plug the ends of the lines to prevent fluid loss and contamination. Discard the sealing washers - new ones should be used when reassembling.
- 10 Remove the steering box retaining bolts (see illustrations) and remove the steering box.
- 11 If it's necessary to detach the Pitman arm from the box sector shaft (to have the box serviced or to switch the arm to a new or

rebuilt unit), make a match mark across the two for correct reassembly. Remove the Pitman arm retaining nut and washer. Use a puller to withdraw the arm if necessary.

Refitting

- 12 Refit the Pitman arm by aligning the match marks made during removal, then tighten the nut to the torque listed in this Chapter's Specifications.
- 13 When fitted the Pitman arm must not have any measurable endfloat within 100° from the neutral position. If play exists, have the following parts checked:
 - a) Sector shaft and bearings (for wear)
 - b) Thrust washer and adjuster bolt head (for wear)
 - c) Ball nut and worm shaft (for wear)
- 14 Refit the steering box. Align the mark on the pinion gear shaft with the mark on the universal joint shaft, and tighten the steering box bolts to the torque listed in this Chapter's Specifications.
- 15 The remainder of refitting is the reverse of removal. Be sure to use new self-locking nuts on the universal joint shaft, the centre track rod, the steering box and the crossmember. Also, use new sealing washers on the hydraulic line fittings.
- 16 Refer to Chapter 1 and fill the power



21.10b This bolt (arrowed) attaches the steering box to the body (the nut, not visible in this photo, is on the front side of the steering box)

steering reservoir with the recommended fluid, then bleed the system as described in Section 23. Check for leakage from the lines and connections.

22 Power steering pump - removal and refitting



Removal

- 1 Raise the vehicle and support it securely on axle stands. Remove the engine undertray.
- 2 On 5-Series E28 ("old-shape") models, discharge the hydraulic system by depressing the brake pedal about 20 times before loosening the hydraulic line fittings.
- 3 Disconnect the fluid return hose, and drain the power steering fluid from the reservoir into a clean container. Disconnect the pressure line from the pump.
- 4 If you need to remove the pulley from the pump, push on the power steering pump drivebelt by hand to increase the tension, and unscrew the pulley nuts or bolts.
- 5 Loosen the power steering pump drivebelt tensioner bolt, and remove the drivebelt (see Chapter 1).
- 6 Remove the mounting bolts (see illustrations) and detach the power steering pump.



22.6a Typical 3-Series power steering pump adjusting bolt (arrowed) . . .

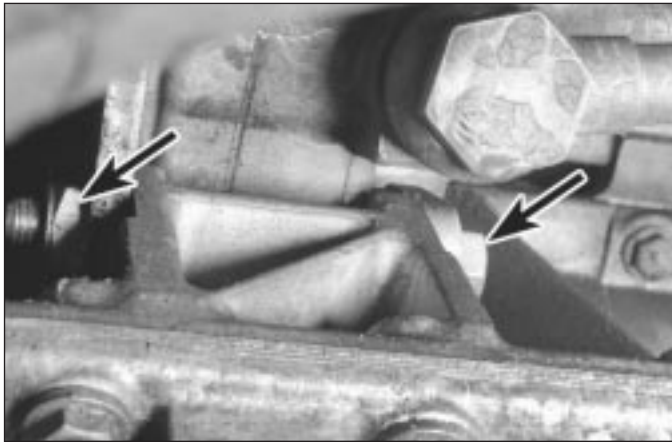

22.6b . . . and mounting nut and bolt (arrowed)



22.6c Typical 5-Series power steering pump mounting bolts (arrowed)

Refitting

7 Refitting is the reverse of removal. Tighten the nuts and bolts securely. Adjust the drivebelt tension (see Chapter 1).

8 Top-up the fluid level in the reservoir (see Chapter 1) and bleed the system (see Section 23).

23 Power steering system - bleeding



1 To bleed the power steering system, begin by checking the power steering fluid level and adding fluid if necessary (see Chapter 1).

2 Raise and support the front of the vehicle on axle stands.

3 Turn the steering wheel from lock-to-lock several times. Recheck the fluid level and top up if necessary.

4 Start the engine and run it at 1000 rpm or less. Turn the steering wheel from lock-to-lock again (three or four times) and recheck the fluid level one more time. **Note:** On 5-



24.3 After removing the steering wheel nut, mark the relationship of the steering wheel to the steering shaft (arrowed) to ensure proper alignment during reassembly

Series E28 ("old-shape") models, pump the brake pedal five or six times before turning the steering wheel. Once the fluid level remains constant, continue turning the wheel back and forth until no more bubbles appear in the fluid in the reservoir.

5 Lower the vehicle to the ground. Run the engine and again turn the wheels from lock-to-lock several more times. Recheck the fluid level. Position the wheels straight-ahead.

24 Steering wheel - removal and refitting



Warning: If the vehicle is equipped with an airbag, do not attempt this procedure. Have it performed by a dealer service department or other qualified specialist, as there is a risk of injury if the airbag is accidentally triggered.



Caution: If the radio in your vehicle is equipped with an anti-theft system, make sure you have the correct activation code before disconnecting the battery.

Note: If, after connecting the battery, the wrong language appears on the instrument panel display, refer to page 0-7 for the language resetting procedure.

Removal

1 Disconnect the battery negative cable.

2 Using a small screwdriver, prise off the BMW emblem in the centre of the steering wheel.

3 Remove the steering wheel nut, and mark the relationship of the steering wheel hub to the shaft (see illustration).

4 On all 3-Series models, and on 1986 and later 5-Series models, turn the ignition key to the first position to unlock the ignition lock.

5 Remove the steering wheel from the

steering shaft. If the wheel is difficult to remove from the shaft, use a steering wheel puller to remove it - don't hammer on the shaft.

Refitting

6 Refitting is the reverse of removal. Be sure to align the match marks you made on the steering wheel and the shaft. Tighten the steering wheel nut to the torque listed in this Chapter's Specifications.

25 Wheels and tyres - general information



Note: For more information on care and maintenance of tyres, refer to Chapter 1.

1 All vehicles covered by this manual are equipped with steel-belted radial tyres as original equipment. Use of other types or sizes of tyres may affect the ride and handling of the vehicle. Don't mix different types or sizes of tyres, as the handling and braking may be seriously affected. It's recommended that tyres be renewed in pairs on the same axle; if only one new tyre is being fitted, be sure it's the same size, structure and tread design as the other.

2 Because tyre pressure has a substantial effect on handling and wear, the pressure on all tyres should be checked at least once a month or before any extended trips (see Chapter 1).

3 Wheels must be renewed if they are bent, heavily dented, leak air, or are otherwise damaged.

4 Tyre and wheel balance is important in the overall handling, braking and performance of the vehicle. Unbalanced wheels can adversely affect handling and ride characteristics, as well as tyre life. Whenever a new tyre is fitted, the tyre and wheel should be balanced.

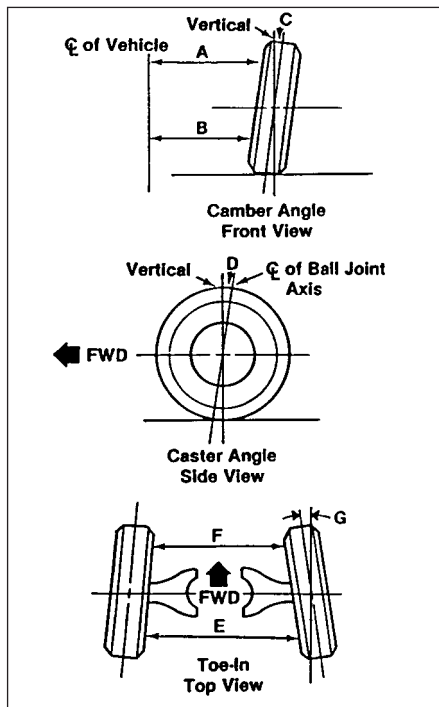

26.1 Wheel alignment details

- 1 $A \text{ minus } B = C$ (degrees camber)
- 2 $E \text{ minus } F = \text{toe-in}$
(expressed in inches or mm)
- 3 $G = \text{toe-in}$ (expressed in degrees)

26 Wheel alignment - general information



Wheel alignment refers to the adjustments made to the wheels so they are in proper angular relationship to the suspension and the road. Wheels that are out of proper alignment not only affect vehicle control, but also increase tyre wear. The front end angles normally measured are camber, castor and toe-in (see illustration). Front wheel toe-in is adjustable on all models; castor is not adjustable. Camber is only adjustable by replacing the strut upper mount with a special eccentric version. Toe-in is adjustable on the rear wheels, but only by replacing the trailing arm outer bushings with special eccentric bushings.

Setting the proper wheel alignment is a very exacting process, one in which complicated and expensive equipment is necessary to perform the job properly. Because of this, you should have a technician with the proper equipment perform these tasks. We will, however, use this space to give you a basic idea of what is involved with wheel alignment so you can better understand the process.

Toe-in is the "turning in" of the wheels. The purpose of a toe specification is to ensure

parallel rolling of the wheels. In a vehicle with zero toe-in, the distance between the front edges of the wheels will be the same as the distance between the rear edges of the wheels. The actual amount of toe-in is normally very small. On the front end, toe-in is controlled by the track rod end position on the track rod. On the rear end, toe-in can only be adjusted by fitting special eccentric bushings in the trailing arm outer mounting. Incorrect toe-in will cause the tyres to wear improperly by making them scrub against the road surface.

Camber is the "tilting" of the wheels from vertical, when viewed from one end of the vehicle. When the wheels tilt out at the top, the camber is said to be positive (+). When the wheels tilt in at the top the camber is negative (-). The amount of tilt is measured in degrees from vertical, and this measurement is called the camber angle. This angle affects the amount of tyre tread which contacts the road, and compensates for changes in the suspension geometry when the vehicle is cornering or travelling over an undulating surface.

Castor is the "tilting" of the front steering axis from the vertical. A tilt toward the rear at the top is positive castor; a tilt toward the front is negative castor. Castor is not adjustable on the vehicles covered by this manual.