

Owner's Manual
for Vehicle



The Ultimate
Driving Machine



323i
328i
328xi
335i

Owner's Manual for Vehicle

Congratulations, and thank you for choosing a BMW.

Thorough familiarity with your vehicle will provide you with enhanced control and security when you drive it. We therefore have this request:

Please take the time to read this Owner's Manual and familiarize yourself with the information that we have compiled for you before starting off in your new vehicle. It contains important data and instructions intended to assist you in gaining maximum use and satisfaction from your BMW's unique range of technical features. The manual also contains information on maintenance designed to enhance operating safety and contribute to maintaining the value of your BMW throughout an extended service life.

This manual is supplemented by a Service and Warranty Information Booklet for US models or a Warranty and Service Guide Booklet for Canadian models.

We wish you an enjoyable driving experience.

BMW AG

© 2006 Bayerische Motoren Werke
Aktiengesellschaft
Munich, Germany
Reprinting, including excerpts, only with the
written consent of BMW AG, Munich.
Order No. 01 41 0 012 928
US English VIII/06, 06 09 500
Printed in Germany
Printed on environmentally friendly paper,
bleached without chlorine, suitable for recycling.

Contents

The fastest way to find information on a particular topic or item is by using the index, refer to page [246](#).

Using this Owner's Manual

- [4](#) Notes
- [6](#) Reporting safety defects

At a glance

- [10](#) Cockpit
- [16](#) iDrive
- [22](#) Voice command system

Controls

- [28](#) Opening and closing
- [44](#) Adjustments
- [53](#) Transporting children safely
- [57](#) Driving
- [72](#) Everything under control
- [86](#) Technology for driving comfort and safety
- [97](#) Lamps
- [101](#) Climate
- [107](#) Practical interior accessories

Driving tips

- [122](#) Things to remember when driving

Navigation

- [130](#) Starting the navigation system
- [131](#) Destination entry
- [143](#) Destination guidance
- [152](#) What to do if ...

Entertainment

- [156](#) On/off and settings
- [160](#) Radio
- [166](#) CD player and CD changer
- [173](#) External audio device

Communications

- [176](#) Telephoning
- [190](#) BMW Assist

Mobility

- [200](#) Refueling
- [202](#) Wheels and tires
- [214](#) Under the hood
- [219](#) Maintenance
- [221](#) Replacing components
- [229](#) Giving and receiving assistance

Reference

- [236](#) Technical data
- [242](#) Short commands for the voice command system
- [246](#) Everything from A-Z

Notes

Using this Owner's Manual

We have tried to make all the information in this Owner's Manual easy to find. The fastest way to find specific topics is to refer to the detailed index at the back of the manual. If you wish to gain an initial overview of your vehicle, you will find this in the first chapter.

Should you sell your BMW some day, please remember to hand over the Owner's Manual as well; it is an important component of your vehicle.

Additional sources of information

Should you have any other questions, your BMW center will be glad to advise you at any time.

Information on BMW, e.g. on technical aspects, can also be found on the Internet at www.bmwusa.com.

Symbols used

 Indicates precautions that must be followed precisely in order to avoid the possibility of personal injury and serious damage to the vehicle.

 Indicates information that will assist you in gaining the optimum benefit from your vehicle and enable you to care more effectively for your vehicle.

 Refers to measures that can be taken to help protect the environment.

◀ Marks the end of a specific item of information.

* Indicates special equipment, country-specific equipment and optional extras, as well as equipment and functions not yet available at the time of printing.

"..." Identifies Control Display texts used to select individual functions.

>...< Verbal instructions to use with the voice command system.

>>...<< Identifies the answers generated by the voice command system.

Symbols on vehicle components

 Indicates that you should consult the relevant section of this Owner's Manual for information on a particular part or assembly.

The individual vehicle

When you ordered your BMW, you chose various items of equipment. This Owner's Manual describes the entire array of options and equipment available with a specific BMW model.

Please bear in mind that the manual may contain information on accessories and equipment that you have not specified for your own vehicle. Sections describing options and special equipment are marked by asterisks * to assist you in identifying possible differences between the descriptions in this manual and your own vehicle's equipment.

If equipment in your BMW is not described in this Owner's Manual, please refer to the accompanying Supplementary Owner's Manuals.

Editorial notice

BMW pursues a policy of continuous, ongoing development that is conceived to ensure that our vehicles continue to embody the highest quality and safety standards combined with advanced, state-of-the-art technology. For this reason, it is possible in exceptional cases that features described in this Owner's Manual could differ from those on your vehicle.

For your own safety

Maintenance and repair

 Advanced technology, e.g. the use of modern materials and powerful electronics, requires specially adapted maintenance and repair methods. You should therefore have the corresponding work on your vehicle performed only by your BMW center or at a workshop that works according to BMW repair procedures with correspondingly trained personnel. If this work is not carried out properly, there is a danger of subsequent damage and related safety hazards. ◀

Parts and accessories

 For your own safety, use genuine parts and accessories approved by BMW.

When you purchase accessories tested and approved by BMW and Original BMW Parts, you simultaneously acquire the assurance that they have been thoroughly tested by BMW to ensure optimum performance when installed on your vehicle.

BMW warrants these parts to be free from defects in material and workmanship.

BMW will not accept any liability for damage resulting from installation of parts and accessories not approved by BMW.

BMW cannot test every product made by other manufacturers to verify if it can be used on a BMW safely and without risk to either the vehicle, its operation, or its occupants.

Original BMW Parts, BMW Accessories and other products approved by BMW, together with professional advice on using these items, are available from all BMW centers.

Installation and operation of non-BMW approved accessories such as alarms, radios, amplifiers, radar detectors, wheels, suspension components, brake dust shields, telephones, including operation of any mobile phone from within the vehicle without using an externally mounted antenna, or transceiver equipment, for instance, CBs, walkie-talkies, ham radio or similar accessories, may cause extensive damage

to the vehicle, compromise its safety, interfere with the vehicle's electrical system or affect the validity of the BMW Limited Warranty. See your BMW center for additional information. ◀



Maintenance, replacement, or repair of the emission control devices and systems may be performed by any automotive repair establishment or individual using any certified automotive part. ◀

California Proposition 65 warning

California law requires us to issue the following warning:



Engine exhaust and a wide variety of automobile components and parts, including components found in the interior furnishings in a vehicle, contain or emit chemicals known to the State of California to cause cancer and birth defects and reproductive harm. In addition, certain fluids contained in vehicles and certain products of component wear contain or emit chemicals known to the State of California to cause cancer and birth defects or other reproductive harm.

Battery posts, terminals and related accessories contain lead and lead compounds. Wash your hands after handling.

Used engine oil contains chemicals that have caused cancer in laboratory animals. Always protect your skin by washing thoroughly with soap and water. ◀

Service and warranty

We recommend that you read this publication thoroughly.

Your BMW is covered by the following warranties:

- ▷ New Vehicle Limited Warranty
- ▷ Rust Perforation Limited Warranty
- ▷ Federal Emissions System Defect Warranty
- ▷ Federal Emissions Performance Warranty
- ▷ California Emission Control System Limited Warranty

Detailed information about these warranties is listed in the Service and Warranty Information Booklet for US models or in the Warranty and Service Guide Booklet for Canadian models.

Reporting safety defects

For US customers

The following applies only to vehicles owned and operated in the US.

If you believe that your vehicle has a defect which could cause a crash or could cause injury or death, you should immediately inform the National Highway Traffic Safety Administration, NHTSA, in addition to notifying BMW of North America, LLC, P.O. Box 1227, Westwood, New Jersey 07675-1227, Telephone 1-800-831-1117.

If NHTSA receives similar complaints, it may open an investigation, and if it finds that a safety defect exists in a group of vehicles, it may order a recall and remedy campaign. However, NHTSA cannot become involved in individual problems between you, your dealer, or BMW of North America, LLC.

To contact NHTSA, you may call the Vehicle Safety Hotline toll-free at 1-888-327-4236 (TTY: 1-800-424-9153); go to <http://www.safercar.gov>; or write to: Administrator, NHTSA, 400 Seventh Street, SW., Washington, DC 20590. You can also obtain other information about motor vehicle safety from <http://www.safercar.gov>

For Canadian customers

Canadian customers who wish to report a safety-related defect to Transport Canada, Defect Investigations and Recalls, may call 1-800-333-0510 toll-free from anywhere in Canada or 1-613-993-9851 from the Ottawa region and from other countries, or contact Transport Canada by mail at: Transport Canada, ASFAD, Place de Ville, Tower C, 330 Sparks Street, Ottawa, ON, K1A 0N5.

You can also obtain other information about motor vehicle safety from <http://www.tc.gc.ca>







At a glance



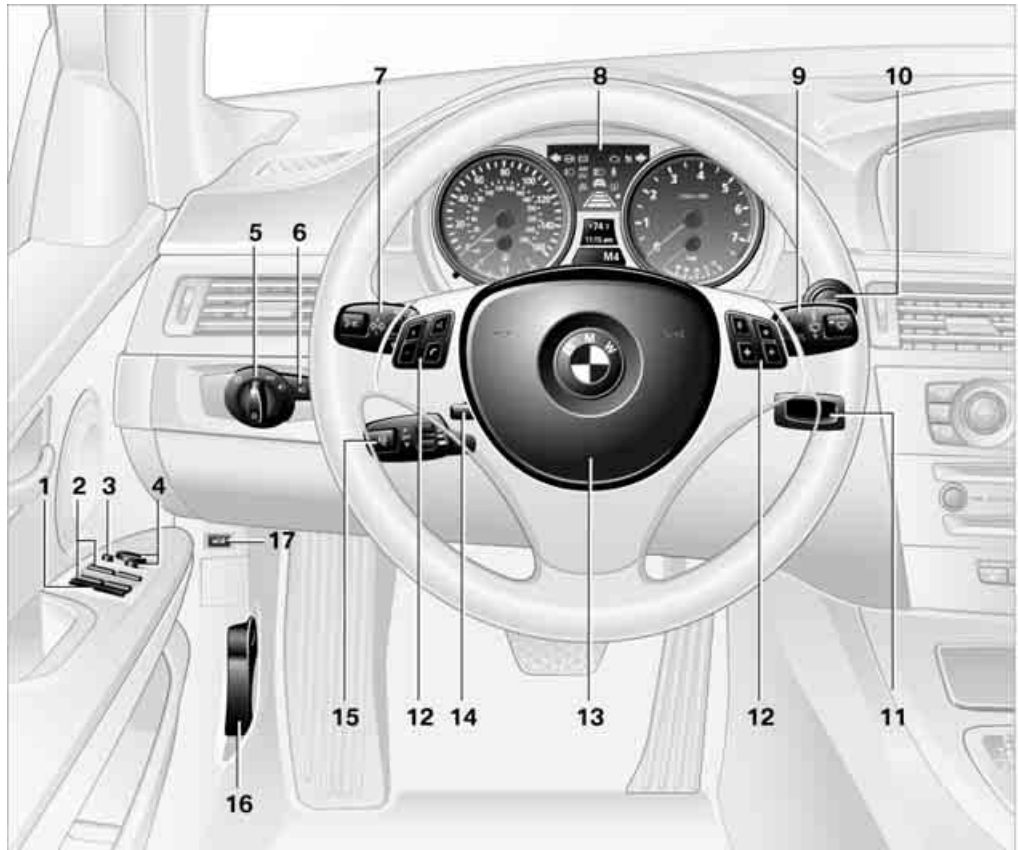

This overview of buttons, switches and displays is intended to familiarize you with your vehicle's operating environment. The section will also assist you in becoming acquainted with the control concepts and options available for operating the various systems.







Cockpit

Around the steering wheel: controls and displays



- 1  Safety switch for electric rear windows [39](#)
- 2  Opening and closing windows [38](#)
- 3 Folding exterior mirrors in and out* [50](#)
- 4 Adjusting exterior mirrors, automatic curb monitor* [50](#)

- 5  Parking lamps [97](#)
-  Low beams [97](#)
-  Automatic headlamp control* [97](#)
-  Adaptive Head Light* [99](#)
- 6  Fog lamps* [99](#)

- 7  Turn signals 61
-  High beams, headlamp flasher 99
-  Roadside parking lamps* 99
-  Computer 74
-  Settings and information about the vehicle 76
-  Instrument lighting 100

8 Instrument cluster 12

9  Windshield wipers 62

 Rain sensor* 62

 Sports Wagon:
Rear window wiper 63

10  Switching the ignition on/off and starting/stopping the engine 57



11 Ignition lock 57

12 Buttons* on the steering wheel

-  Telephone*:
 - ▷ Press: accepting and ending a call, starting dialing* selected phone numbers. Redialing if no phone number is selected
 - ▷ Press longer: redialing

 Volume

 Activating/deactivating voice command system* 22

 Changing radio station
Selecting music track
 Scrolling through phone book and lists with stored phone numbers

 Individually programmable 51

 Individually programmable 51

13 Horn: the entire surface

14 Adjusting the steering wheel 51

15  Cruise control* 64

 Active cruise control* 66

16 Releasing the hood 214

17 Opening the tailgate/luggage compartment lid*

Instrument cluster

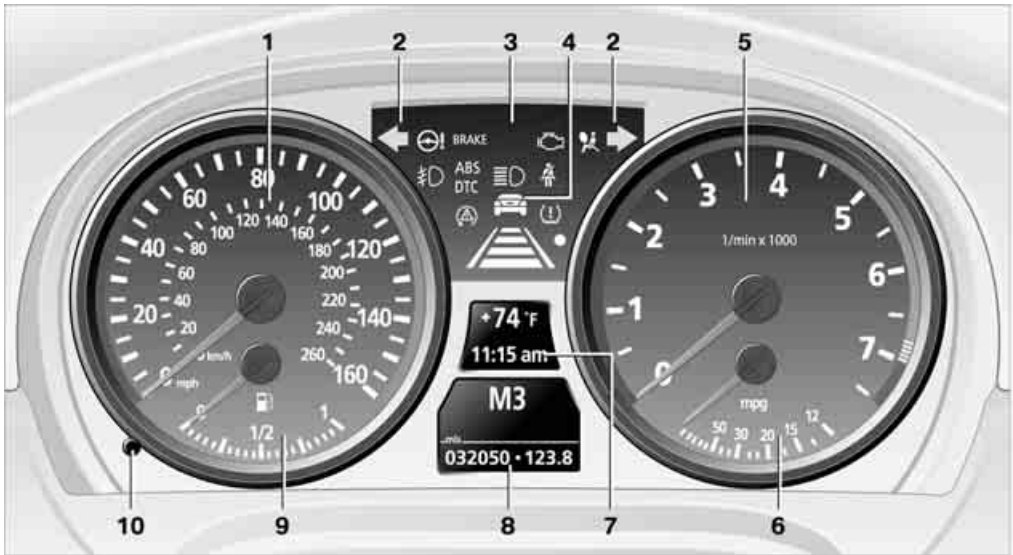

WAGO/TOC/0001

- 1 Speedometer
- 2 Indicator lamps for turn signals
- 3 Indicator and warning lamps [13](#)
- 4 Displays for active cruise control* [66](#)
- 5 Tachometer [72](#)
- 6 Energy Control* [73](#)
Engine oil temperature* [73](#)
- 7 Display for
 - ▷ Clock [72](#)
 - ▷ Outside temperature [72](#)
 - ▷ Indicator and warning lamps [82](#)
- 8 Display for
 - ▷ Position of automatic transmission* [59](#)
 - ▷ Computer [74](#)
 - ▷ Date of next scheduled service, and remaining distance to be driven [77](#)
 - ▷ Odometer and trip odometer [72](#)
 - ▷ Checking engine oil level* [215](#)
 - ▷ Settings and information [76](#)
 - ▷ There is a Check Control message [82](#)
- 9 Fuel gauge [73](#)
- 10 Resetting the trip odometer [72](#)

Indicator and warning lamps

The concept

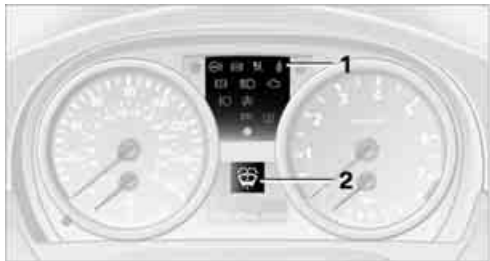

Indicator and warning lamps can light up in various combinations and colors in the indicator area **1** or **2**.

Some lamps are checked for proper functioning and thus come on briefly when the engine is started or the ignition is switched on.

Explanatory text messages



Text messages at the lower edge of the Control Display explain the meaning of the displayed indicator and warning lamps.

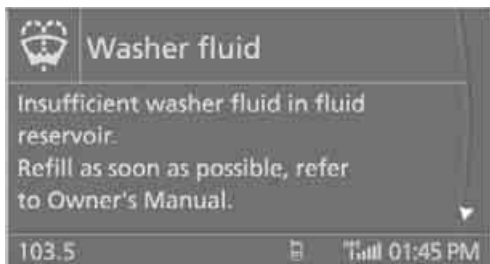



You can call up more information, e.g. on the cause of a malfunction and on how to respond, via Check Control, refer to page [82](#).

In urgent cases, this information will be shown as soon as the corresponding lamp comes on.

Indicator lamps without text messages

The following indicator lamps in the indicator area **1** signal that the associated functions are activated:

 High beams/headlamp flasher [99](#)

 Fog lamps* [99](#)

 Lamp flashes:
DSC or DTC is regulating the propulsive forces in order to maintain driving stability [88](#)

 Parking brake applied [59](#)

Around the center console: controls and displays



WIPAC/UCD/WH

- 1 Microphone for voice command system* and for telephone in hands-free mode* 229
- 2 SOS: initiating an Emergency Request call* 229
- 3 Reading lamps 100
- 4 Glass roof/panorama glass roof* 41
- 5 Interior lamps 100
- 6 Passenger airbag status lamp* 96
- 7 Control Display 16
- 8 Hazard warning flashers
- 9 DTC Dynamic Traction Control 88
- 10 Central locking system 32
- 11 Automatic climate control



Air distribution to the windshield 102



Air distribution to the upper body area 102



Air distribution to the footwell 102

AUTO

Automatic air distribution and flow rate 103



Cooling function 104



AUC Automatic recirculated-air control 103



Recirculated-air mode 103



Maximum cooling 103



Residual heat mode 104



Air flow rate 103



Defrosting windows 104



Rear window defroster 104

12 Ejecting

- ▷ Audio CD 156
- ▷ Navigation DVD 130

13 Changing

- ▷ Radio station 160
- ▷ Track 167

14



Heated seats* 48



PDC Park Distance Control* 86



Sedan:
Roller sun blind* 110



Hill Descent Control HDC* 88

15 Controller 16

Can be turned, pressed, or moved horizontally in four directions

16 Activating voice command system* 22

17 Opening start menu on Control Display 17

18 Drive for navigation DVD 130

19 Switching audio sources on/off and adjusting volume 156

20 Drive for audio CDs 156

iDrive integrates the functions of a large number of switches. This allows these functions to be operated from a single central position. The following section provides an introduction to

basic menu navigation. The control of the individual functions is described in connection with the relevant equipment.

Controls

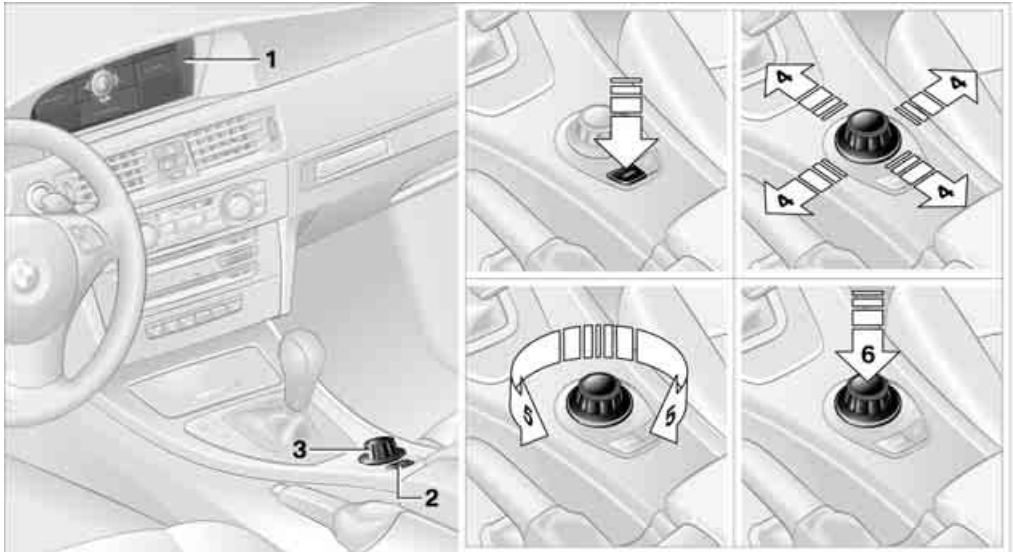

- 1 Control Display
- 2 **MENU** button
Opening start menu
- 3 Controller
The controller can be used to select menu items and to adjust settings:
 - ▷ Move in four directions, arrow 4
 - ▷ Turn, arrow 5
 - ▷ Push, arrow 6

! Operate the controller only when traffic and road conditions allow this, to avoid endangering the car's occupants and other road users by being distracted. ◀

Menu overview

Communication

- ▷ Telephone*
- ▷ BMW Assist* or TeleService*

Navigation

- ▷ Navigation system
- ▷ Onboard information, e.g. for displaying the average fuel consumption.

Entertainment

- ▷ Radio
- ▷ CD player and CD changer*
- ▷ External audio device

Climate

- ▷ Vent settings
- ▷ Automatic programs
- ▷ Parked car operation

i menu

- ▷ Switching off Control Display
- ▷ Tone and display settings
- ▷ Settings for your vehicle, e.g. for the central locking system
- ▷ Display of service requirements and dates for statutory emissions and vehicle inspections
- ▷ Settings for telephone

Operating principle

As of radio readiness, the following message appears on the Control Display:

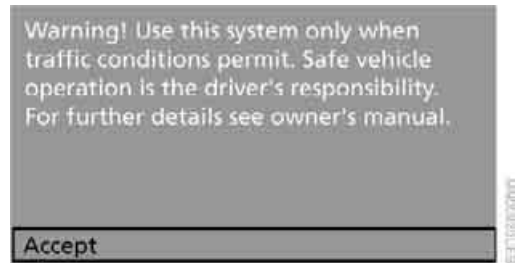

To hide the message:

Press the controller.

The start menu is displayed.

The message is automatically hidden after approx. 10 seconds.

Start menu



All iDrive functions can be called up via five menu items.

Opening start menu

Press the **MENU** button.

To open the start menu from the **i** menu:

Press the **MENU** button twice.

Calling up menu items in the start menu

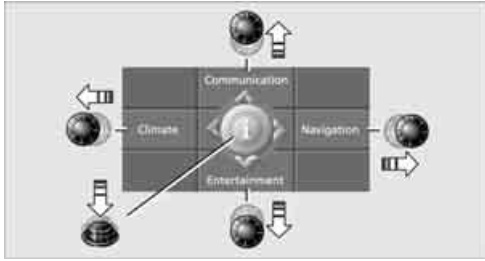

As of radio readiness, refer to page 57:
Via the start menu you can call up the four menu items of Communication, Navigation, Entertainment and Climate by moving the controller forwards, backwards, to the left or to the right.
You can call up the **i** menu by pressing the controller.

Convenient call-up of menu items

The convenient call-up function enables you to:

- ▷ Call up a menu item from the start menu in the view last displayed
- ▷ Switch directly between Communication, Navigation, Entertainment and Climate without having to press the **MENU** button

To do so, move the controller in the corresponding direction and hold it for more than approx. 2 seconds.

Displays in menu

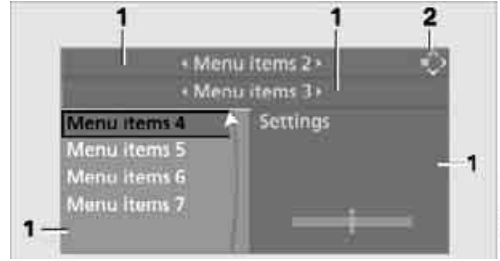

- 1 Each menu is subdivided into fields. The active field is highlighted.
- 2 A symbol indicates the start menu item last selected.

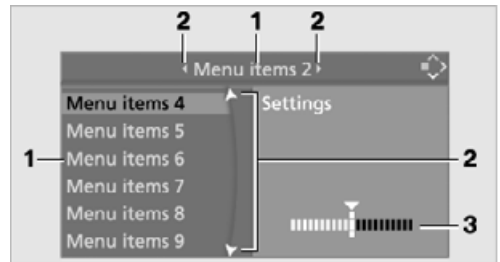
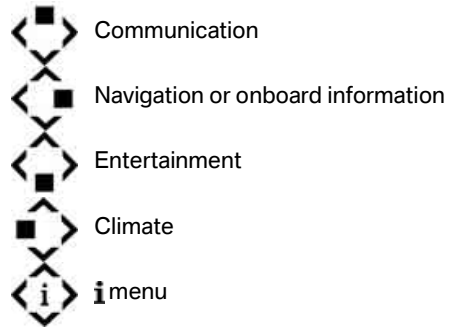

- 1 Menu items are usually grouped in horizontal or vertical lists.
- 2 In these lists, arrows indicate the possibility of accessing other menu items that are not currently visible.
- 3 Settings are represented graphically or as numerical values.

Operating principle at a glance

The following is a general description of operations using iDrive.

For an exemplary step-by-step application refer to Setting the time, page 80.

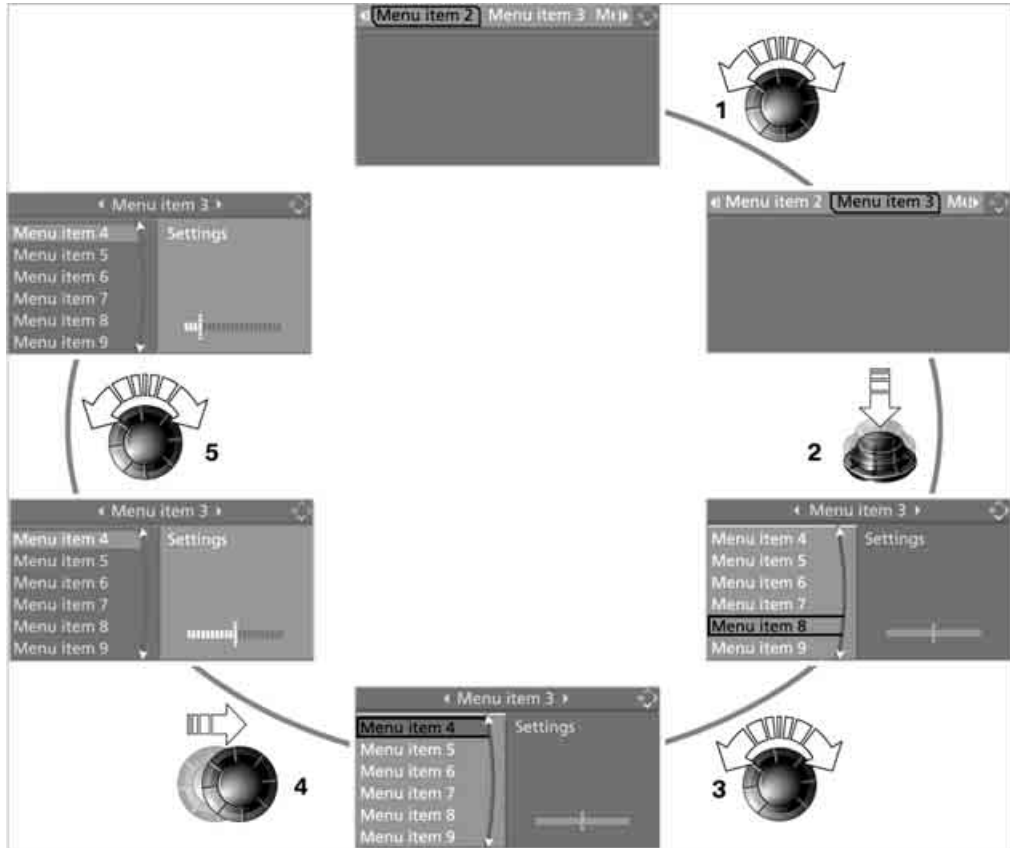

- 1** Select a menu item:
 - ▶ Turn the controller; the highlight marker moves
 - ▶ Menu items in white can be selected by highlighting them
- 2** To activate a menu item:
 - ▶ Press the controller
 - ▶ New menu items are displayed or the function is executed
- 3** Select a menu item: refer to 1
- 4** To switch between fields:
 - ▶ Briefly move the controller to the left, right, forward, or backward
 - ▶ Release the controller
 - ▶ The active field is brighter in color
- 5** To adjust settings:
 - ▶ Turn the controller
 - ▶ Graphic display, numerical value or text displays can be changed
 - ▶ Confirm by changing the field

Status information



- 1 Display for:
 - ▷ Entertainment: Radio, CD or
 - ▷ Telephone* in "Communication": Name of the connected mobile phone, network search or no network
 - ▷ "BMW Assist"*: Active voice connection with a BMW Assist service
- 2 Entertainment audio output off
- 3 Display for traffic information*: "TI":
Traffic information for the navigation system can be received and the transmission is switched on
- 4 Display for:
 - ▷ New entries present in "Missed calls"*
 - ▷ Roaming active
- 5 It is possible to make calls* if the mobile phone is paired with the vehicle
 Reception strength of mobile phone network, display depending on mobile phone
- 6 Time

Other displays:

Status information is temporarily hidden during Check Control message displays or entries via the voice command system*.

Assistance window*



Additional information can be displayed in the assistance window:

- ▷ The computer or the trip computer*
- ▷ The arrow or map view in vehicles with navigation system*
- ▷ The current position*

Selecting display

1. Move the controller to the right to change to the assistance window and press the controller.

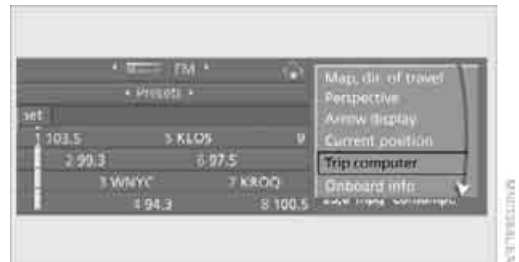

2. Select a menu item.
3. Press the controller.

Switching assistance window on/off

1. Move the controller to the right to change to the assistance window and press the controller.
2. Select "Assist. window off" and press the controller.



To turn back on, switch to the assistance window and press the controller.

Switching Control Display off/on

1. Press the **MENU** button.
This opens the start menu.
2. Press the controller to open the **i** menu.
3. Select "Display off" and press the controller.



Press the controller to switch on.

Voice command system*

The concept

The voice command system allows you to control operation of various vehicle systems without removing your hands from the steering wheel.

Individual menu items on the Control Display can be spoken as commands. It is not necessary to use the controller.

The voice command system transforms your oral commands into control signals for the selected systems and provides support in the form of instructions or questions.

The voice command system uses a special microphone located in the area of the interior rearview mirror, refer to page 14.

Precondition

Via iDrive, select the language in which the voice command system is operating, so that the spoken commands can be identified. Selecting the language for iDrive, refer to page 85.

Symbols in the Owner's Manual

-  >...< Say the specified commands word for word.
- >>...<< Indicates responses of the voice command system.

Saying commands

Activating voice command system

1. Press the  button on the steering wheel or in the center console.



 This symbol on the Control Display and an acoustic signal indicate that the voice command system is ready to receive spoken commands.



2. Say the command.
The command appears on the Control Display.



 This symbol appears on the Control Display when you can enter additional commands.

If no further commands are possible, continue by operating the item of equipment via iDrive.

Terminating or canceling voice command system

Press the  button on the steering wheel or in the center console or

 ›Cancel‹

Commands

Having the possible commands read aloud

You can have the system read aloud the possible commands related to the selected menu item on the Control Display.

To have the possible commands read out to you:

 ›Options‹

For instance, if you have selected "CD" the commands available for operating the CD player and CD changer are read out*.

Opening help

 ›Help‹

Using alternative commands

There are often a number of commands to run a function, e.g.:

 ›Radio on‹ or ›Turn radio on‹

Calling up functions immediately via short commands

Short commands enable you to perform certain functions immediately, irrespective of which menu item is selected, refer to page 242.

Opening the start menu

 ›Main menu‹

Example: selecting a track

1. If necessary, switch on entertainment audio output.
2. Press the  button on the steering wheel or in the center console.

 3. ›Entertainment‹
The system says:
››Entertainment‹‹



 4. ›CD‹
The system says:
››CD on‹‹



5. Press the  button on the steering wheel or in the center console.
6. Select a track, e.g.:
 ›Track 1‹
 The system says:
 ››Track 1‹‹



Notes

 For information on voice control of the telephone, refer also to the separate Owner's Manual. ◀

For voice commands, bear in mind the following:

- ▷ Pronounce the commands and digits smoothly and at normal volume, avoiding excessive emphases and pauses. The same applies to spelling when entering a destination for navigation.
- ▷ Always speak the commands in the language of the voice command system.
- ▷ When selecting a radio station, use the standard pronunciation of the station name.
- ▷ For entries in the voice-activated phone book, only use names in the language of the voice command system and no abbreviations
- ▷ Keep the doors, windows and glass roof/panorama glass roof closed to prevent interference from outside noise.
- ▷ Avoid ambient noise in the vehicle while speaking.





Controls

This chapter is intended to provide you with information for complete control of your vehicle. All features and accessories that are useful for driving and your safety, comfort and convenience, are described here.

Opening and closing

Keys/remote controls



Each remote control contains a rechargeable battery that is automatically recharged when it is in the ignition lock while the car is being driven. Use each remote control at least twice a year for longer road trips in order to maintain the batteries' charge status. In cars with convenient access*, the remote control contains a replaceable battery, refer to page 38.

The settings called up and implemented when the car is unlocked depend on which remote control is used to unlock the car, refer to Personal Profile, page 28.

In addition, information about service requirements is stored in the remote control, refer to Service data in the remote control, page 219.

Integrated key



Press button 1 to release the key.

The integrated key fits the following locks:

- ▷ Glove compartment, refer to page 110
- ▷ Driver's door, refer to page 31

- ▷ Sedan:
Luggage compartment lid, refer to page 33

New remote controls

Your BMW center can supply new remote controls with integrated keys as additional units or as replacements in the event of loss.

Personal Profile

The concept

You can set many of your BMW's functions to suit your personal needs and preferences. Without any action on your part, Personal Profile ensures that most of these settings are stored for the remote control currently in use. When you unlock the car, the remote control used for the purpose is recognized and the settings stored for it are called up and implemented.

This means that your personal settings will be activated for you, even if in the meantime your car was used by someone else with another remote control and the corresponding settings. The individual settings are stored for up to three remote controls.

Personal Profile settings

For more information on specific settings, refer to the specified pages.

- ▷ Response of the central locking system when the car is unlocked, refer to page 29
- ▷ Automatic locking of the vehicle, refer to page 32
- ▷ Automatic call-up* of the driver's seat and exterior-mirror positions after unlocking, refer to page 48
- ▷ Functions assigned to the programmable buttons* on the steering wheel, refer to page 51
- ▷ 12h/24h mode of the clock, refer to page 81

- ▷ Date format, refer to page [82](#)
- ▷ Brightness of the Control Display, refer to page [85](#)
- ▷ Language on the Control Display, refer to page [85](#)
- ▷ Units of measure for fuel consumption, distance covered/remaining distances, and temperature, refer to page [77](#)
- ▷ Show visual warning for Park Distance Control PDC*, refer to page [86](#)
- ▷ Automatic climate control: AUTO program, activating/deactivating cooling function and automatic recirculated-air control, setting temperature, air flow rate and distribution, refer to page [102 ff](#)
- ▷ Audio volume, refer to page [157](#)
- ▷ Tone control, refer to page [157](#)
- ▷ Speed-dependent volume control, refer to page [157](#)

Central locking system

The concept

The central locking system is ready for operation whenever the driver's door is closed.

The system simultaneously engages and releases the locks on the following:

- ▷ Doors
- ▷ Luggage compartment lid/tailgate
- ▷ Fuel filler door

Operating from outside

- ▷ Via the remote control
- ▷ Via the door lock
- ▷ In cars with convenient access*, via the handles on the driver's and front passenger's doors

The anti-theft system is also operated at the same time. It prevents the doors from being unlocked using the lock buttons or door handles. In addition, if the remote control is used, the interior lamps and the door's courtesy lamps* are also switched on or off. The alarm

system* is also armed or disarmed. For further details of the alarm system, refer to page [35](#).

Operating from inside

By means of the button for central locking, refer to page [32](#).

In the event of a sufficiently severe accident, the central locking system unlocks automatically. In addition, the hazard warning flashers and interior lamps come on.

Opening and closing: from outside

Using the remote control



Persons or animals in a parked vehicle could lock the doors from the inside. You should therefore take the remote control with you when you leave the vehicle so that the latter can be opened from outside. ◀

Unlocking

Press the  button.

The interior lamps and the courtesy lamps* come on. You can also set the way in which the car is unlocked. The setting is stored for the remote control currently in use.

iDrive, for operating principle refer to page [16](#).

1. Press the **MENU** button.
This opens the start menu.
2. Press the controller to open the **i** menu.
3. Select "Settings" and press the controller.
4. Select "Vehicle / Tires" and press the controller.
5. If necessary, move the highlight marker to the uppermost field. Turn the controller

until "Door locks" is selected and press the controller.



6. Select "Central locking" and press the controller.
7. Select "Unlock button" and press the controller.
8. Select a menu item:
 - ▷ "All doors"
Press the button once to unlock the entire vehicle.
 - ▷ "Driver's door only"
Press the button once to unlock only the driver's door and the fuel filler door. Press the button twice to unlock the entire vehicle.



9. Press the controller.

Convenience opening

Hold the button down. The windows and the glass roof*/panorama glass roof* are opened.

Locking

Press the LOCK button.

Switching on interior lamps

While the car is locked:
Press the LOCK button.

You can also use this function to locate your vehicle in parking garages etc.

Panic mode*

You can also trigger the alarm system if you find yourself in a dangerous situation:

Press the button for at least three seconds.

To switch off the alarm: press any button.

Sedan:

Unlocking the luggage compartment lid

Press the button for a longer period.

The luggage compartment lid opens a short distance, regardless of whether it was locked or unlocked.

In order to avoid damage, make sure there is sufficient clearance in all directions before opening the luggage compartment lid. A previously locked luggage compartment lid is locked again after closing.

Before and after each trip, check that the luggage compartment lid has not been inadvertently unlocked. ◀

Sports Wagon:

Unlocking the tailgate

Press the button for a longer period.

The tailgate opens a short distance, regardless of whether it was locked or unlocked.

A previously locked tailgate is locked again after closing.

Before and after each trip, check that the tailgate has not been inadvertently unlocked. ◀

If you press the button on the remote control a second time for a longer period within three seconds, the roll-up cover is raised*. Before closing the tailgate, press the roll-up cover downward until it engages. ◀

Setting confirmation signals

You can program the vehicle to confirm when it has been locked or unlocked.

1. Open the start menu.
2. Press the controller to open the menu.

3. Select "Settings" and press the controller.
4. Select "Vehicle / Tires" and press the controller.
5. If necessary, move the highlight marker to the uppermost field. Turn the controller until "Door locks" is selected and press the controller.
6. Select "Confirmation" and press the controller.



7. Select the desired signal.
8. Press the controller.
 - The signal is activated.

Malfunctions

The remote control may malfunction due to local radio waves. If this occurs, unlock and lock the car at the door lock with the integrated key. If the car can no longer be locked with a remote control, the battery in the remote control is discharged. Use this remote control during an extended drive; this will recharge the battery, refer to page 28.

For US owners only

The transmitter and receiver units comply with part 15 of the FCC/Federal Communications Commission regulations. Operation is governed by the following:

FCC ID:
LX8766S
LX8766E
LX8CAS

Compliance statement:

This device complies with part 15 of the FCC Rules. Operation is subject to the following two conditions:

- ▷ This device must not cause harmful interference, and
- ▷ This device must accept any interference received, including interference that may cause undesired operation.

 Any unauthorized modifications or changes to these devices could void the user's authority to operate this equipment. ◀

Using the door lock

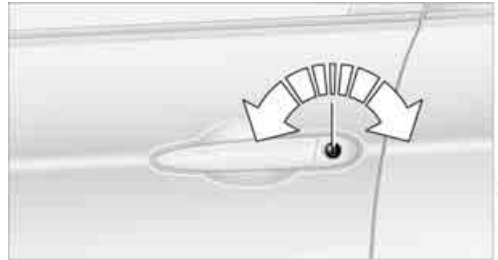

You can set the way in which the car is unlocked, refer to page 29.

Convenient operation

At the door lock, you can operate the windows and glass roof*/panorama glass roof*.

Hold the key in the position for unlocking or locking.

 Watch during the closing process to be sure that no one is injured. Releasing the key stops the operation. ◀

Manual operation

In the event of an electrical malfunction, you can lock and unlock the driver's door by turning the integrated key to the corresponding limit positions in the door lock.

Opening and closing: from inside

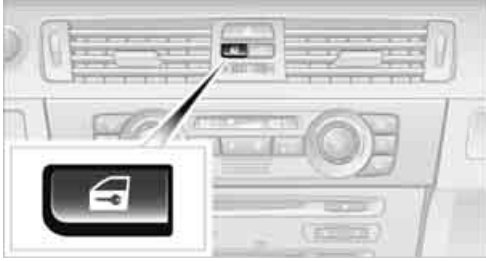

This button serves to unlock or lock doors and the luggage compartment lid/tailgate, but does not activate the anti-theft system. The fuel filler door remains unlocked.

Automatic locking

You can also set the situations in which the car locks:

iDrive, for operating principle refer to page 16.

1. Press the **MENU** button.
This opens the start menu.
2. Press the controller to open the **i** menu.
3. Select "Settings" and press the controller.
4. Select "Vehicle / Tires" and press the controller.
5. If necessary, move the highlight marker to the uppermost field. Turn the controller until "Door locks" is selected and press the controller.
6. Select "Central locking" and press the controller.



7. Select a menu item:
 - ▷ "Relock door if not opened"
The central locking system automatically locks the vehicle after a short time when no door has been opened.
 - ▷ "Lock after driving"
The central locking system automatically locks the vehicle as soon as you drive off.
8. Press the controller.
 - The setting is selected.

The setting is stored for the remote control currently in use.

Unlocking and opening doors

- ▷ Either unlock the doors together using the button for the central locking system and then pull the door handle above the armrest or
- ▷ pull on the door handle of each door twice: the first time unlocks the door, the second time opens it.

Locking

- ▷ Use the central locking button to lock all of the doors simultaneously, or
- ▷ press down the safety lock button of a door. To prevent you from being locked out, the open driver's door cannot be locked using the lock button.

 Persons or animals in a parked vehicle could lock the doors from the inside. You should therefore take the remote control with you when you leave the vehicle so that the latter can be opened from outside. ◀

Luggage compartment lid/tailgate

 In order to avoid damage, make sure there is sufficient clearance in all directions before opening the luggage compartment lid/tailgate. ◀

Opening from inside



Press the button: the luggage compartment lid/tailgate opens unless it has been locked.

Opening from outside

Sedan



Press the button, see arrow, or the  button on the remote control for a longer period. The luggage compartment lid will open slightly. It can now be swung upwards.

Sports Wagon



Press the button, see arrow, or the  button on the remote control for a longer period. The tailgate will open slightly. It can now be swung upwards.

Press the button, see arrow, or the  button on the remote control a second time for a longer

period within three seconds: the roll-up cover is raised.



Before closing the tailgate, press the cover downward until it engages.

Opening manually

Sedan

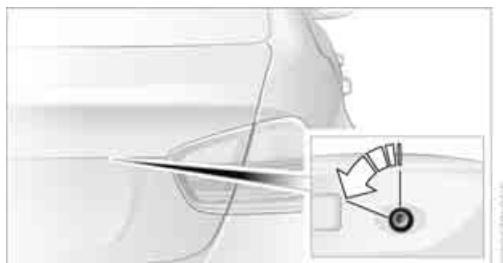

The integrated key of the remote control, refer to page 28, fits the luggage compartment lid lock.

Turn the integrated key of the remote control or the spare key all the way to the left: the luggage compartment lid opens.

 If you unlock and open the luggage compartment lid with the key while the alarm system is armed, the alarm will be triggered. Switching off an alarm, refer to page 36. ◀

Sports Wagon

In the event of an electrical malfunction:

1. From the cargo bay, swing the cover on the tailgate upward.

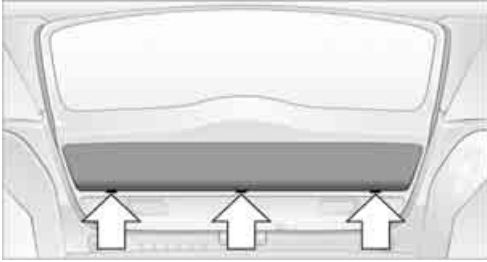

2. Pull the ring upward. The tailgate is unlocked.

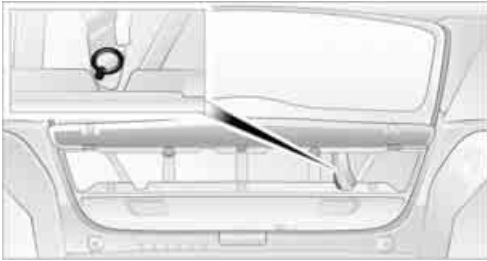

3. Open the tailgate and close the cover again. The tailgate is locked as soon as it is pressed shut.

Locking or unlocking separately

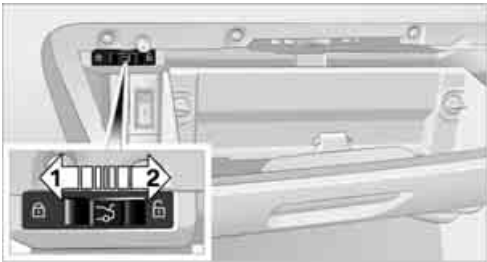

The switch is located in the glove compartment.

- 1 Locking the luggage compartment lid
- 2 Unlocking the luggage compartment lid

Locking separately

Push the switch in the direction of arrow 1. The luggage compartment lid is locked and cannot be unlocked using the central locking system.

If you give the remote control without the integrated key to someone else while the glove compartment is locked, the luggage compartment lid cannot be opened. This is an advantage when valet parking, for example.

Unlocking separately

Push the switch in the direction of arrow 2.

Emergency release



Pull the lever in the cargo bay. The luggage compartment lid is unlocked.

Closing

Sedan

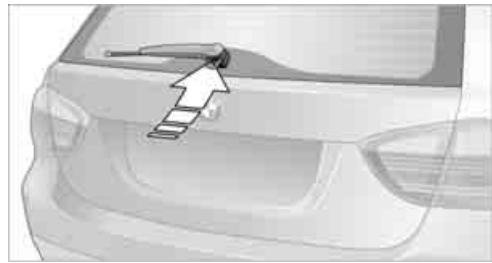

Press the button: the rear window opens slightly. It can now be swung upwards.

Press the window shut to close it.

⚠ Make sure that the corners of any pointed or sharp-edged cargo are padded if they could bump against the rear window while the vehicle is in motion, otherwise the heating elements of the rear window could be damaged. ◀

Sports Wagon



The handle recesses on the interior trim of the luggage compartment lid/tailgate make it easier to pull down.

⚠ Make sure that the closing path of the luggage compartment lid/tailgate is clear, otherwise injuries may result. ◀

Sports Wagon: opening and closing the rear window

Small items can be loaded and unloaded quickly when the rear window is opened separately.

▶ The roll-up cover is raised when the rear window is opened. Before closing the rear window, press the roll-up cover downward until it engages. ◀

Alarm system*

The concept

The vehicle alarm system responds:

- ▶ When a door, the hood or the luggage compartment lid/tailgate is opened
- ▶ To movements inside the vehicle: Interior motion sensor, refer to page 36
- ▶ When the car's inclination changes, for instance if an attempt is made to jack it up and steal the wheels or to raise it prior to towing away
- ▶ When there is an interruption in the power supply from the battery

The alarm system signals unauthorized entry attempts for a short time by means of:

- ▶ An acoustic alarm
- ▶ Switching on the hazard warning flashers
- ▶ Flashing the high beams

Arming and disarming

When you lock or unlock the vehicle, either with the remote control or at the door lock, the alarm system is armed or disarmed at the same time.

You can open the luggage compartment lid/tailgate even when the alarm system is armed, by pressing the  button on the remote control, refer to page 30. The lid is locked and monitored again as soon as you close it.

Switching off an alarm

- ▷ Unlock the car with the remote control, refer to page 29.
- ▷ Insert the remote control all the way into the ignition lock.

Indicator lamp displays



- ▷ The indicator lamp under the inside rearview mirror flashes continuously: the system is armed.
- ▷ The indicator lamp flashes after locking: doors, hood, luggage compartment lid/tailgate or rear window are not properly closed. Even if you do not close the alerted area, the system begins to monitor the remaining areas, and the indicator lamp flashes continuously after approx. 10 seconds. However, the interior motion sensor is not activated.
- ▷ The indicator lamp goes out after unlocking: your vehicle has not been disturbed while you were away.
- ▷ If the indicator lamp flashes after unlocking until the remote control is inserted in the ignition, but for no longer than approx. 5 minutes: your vehicle has been disturbed while you were away.

Tilt alarm sensor

The tilt of the vehicle is monitored. The alarm system reacts, e.g. to attempts to steal a wheel or tow the vehicle.

Interior motion sensor

In order for the interior motion sensor to function properly, the windows and glass sunroof must be completely closed.

Avoiding unintentional alarms

The tilt alarm sensor and interior motion sensor may be switched off at the same time. This prevents unintentional alarms, e.g. in the following situations:

- ▷ In duplex garages
- ▷ During transport on car-carrying trains, boats/ships or on a trailer
- ▷ When animals are to remain in the vehicle

Switching off tilt alarm sensor and interior motion sensor

Press the  LOCK button on the remote control again as soon as the vehicle is locked.

The indicator lamp comes on for approx. two seconds, then begins to flash steadily. The tilt alarm sensor and the interior motion sensor are switched off until the next time the vehicle is unlocked and subsequently locked again.

Convenient access*

Convenient access enables you to enter your vehicle without needing to hold the remote control in your hand. All you need to do is wear the remote control close to your body, e.g. in your jacket pocket. The vehicle automatically detects the corresponding remote control within the immediate vicinity or in the passenger compartment.

Convenient access supports the following functions:

- ▷ Unlocking/locking the vehicle
- ▷ Unlocking the luggage compartment lid/tailgate separately

- ▷ Engine starting
- ▷ Convenient closure

Functional requirement

- ▷ The vehicle or the luggage compartment lid/tailgate can only be locked when the vehicle detects that the remote control currently in use is outside of the vehicle.
- ▷ The vehicle cannot be locked or unlocked again until after approx. 2 seconds.
- ▷ The engine can only be started when the vehicle detects that the remote control currently in use is inside the vehicle.

Comparison to standard remote controls

In general, there is no difference between using convenient access or pressing the buttons on the remote control to carry out the functions mentioned above. You should therefore first familiarize yourself with the instructions on opening and closing starting on page 28.

Special features regarding the use of convenient access are described below.

▷ If you notice a brief delay while opening or closing the windows or glass sunroof, the system is checking whether a remote control is inside the vehicle. Please repeat the opening or closing procedure, if necessary. ◀

Unlocking

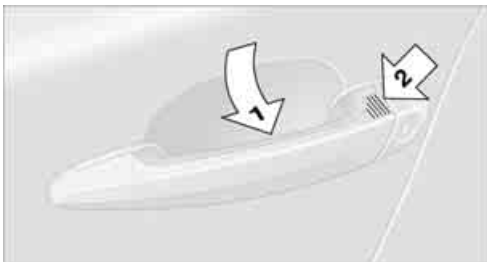

Grasp the handle on the driver's or front passenger's door completely, arrow 1. This corresponds to pressing the  button.

If a remote control is detected inside the car after the vehicle is unlocked, the electric steering wheel lock is released, refer to page 57.

Locking

Touch the surface, arrow 2, with your finger for approx. 1 second. This corresponds to pressing the  LOCK button.

▷ To preserve the battery, please make sure that the ignition and all electrical consumers are switched off before locking the vehicle. ◀

Convenient closure

For convenient closure, keep your finger on the surface, arrow 2.

Unlocking the luggage compartment lid/tailgate separately

Press the button on the outside of the luggage compartment lid/tailgate. This corresponds to pressing the  button.

▷ If the vehicle detects that a remote control has been accidentally left inside the locked vehicle's cargo bay after the luggage compartment lid/tailgate or rear window is closed, the lid will reopen. The hazard warning flashers flash and an acoustic signal* sounds. ◀

Switching on radio readiness

Radio readiness is switched on by pressing the start/stop button, refer to page 57.

▷ Do not depress the brake or the clutch, otherwise the engine will start. ◀

Starting the engine

You can start the engine or switch on the ignition when a remote control is inside the vehicle. It is not necessary to insert a remote control into the ignition switch, refer to page 57.

Switch off the engine in cars with automatic transmission

The engine can only be switched off when the selector lever is in position P, refer to page 58. To switch the engine off when the selector lever is in position N, the remote control must be in the ignition switch.

Before driving a vehicle with automatic transmission into a car wash

1. Insert remote control into ignition switch.
2. Depress the brake.
3. Move the selector lever to position N.
4. Switch off the engine.

The vehicle can roll.

Malfunction

Convenient access may malfunction due to local radio waves. If this happens, open or close the vehicle via the buttons on the remote control or using the integrated key. To start the engine afterward, insert the remote control into the ignition switch.

Warning lamps



The warning lamp in the instrument cluster lights up when you attempt to start the engine: the engine cannot be started. The remote control is not inside the vehicle or is malfunctioning. Take the remote control with you inside the vehicle or have it checked. If necessary, insert another remote control into the ignition switch.



The warning lamp in the instrument cluster lights up while the engine is running: the remote control is no longer inside the vehicle. After the engine is switched off, the engine can only be restarted within approx. 10 seconds.



The indicator lamp in the instrument cluster comes on and a message appears on the Control Display: replace the battery in the remote control.

Replacing the battery

The remote control for convenient access contains a battery that will need to be replaced from time to time.

1. Take the integrated key out of the remote control, refer to page 28.



2. Remove the cover.
3. Insert the new battery with the plus side facing up.
4. Press the cover on to close.



Take the old battery to a battery collection point or to your BMW center. ◀

Windows



To prevent injuries, exercise care when closing the windows and keep them in your field of vision until they are shut. Take the remote control with you when you leave the car, otherwise children could operate the electric windows and possibly injure themselves. ◀

Opening, closing



- ▶ Press the switch to the resistance point. The window continues to open as long as you keep the switch pressed.
- ▶ Press the switch beyond the resistance point. The window opens automatically. Press the

switch again to stop the opening movement.

You can close the windows in the same manner by pulling the switch.

There are separate switches in the rear seat armrests.

After switching off the ignition

When the remote control is removed or the ignition is switched off, you can still operate the windows for approx. 1 minute as long as no door is opened.

For information on convenient operation via the remote control or the door lock, refer to page 30 or 31. For information on closing with convenient access, refer to Locking on page 30.

Pinch protection system

If the closing force exceeds a specific value as a window closes, the closing action is interrupted and the window reopens slightly.

 Despite the pinch protection system check and clear the window's travel path prior to closing it, otherwise the safety system might fail to detect certain kinds of obstructions, such as thin objects, and the window would continue closing.

Do not install any accessories that might interfere with window movement. Otherwise the pinch protection system could be impaired. ◀

Closing without pinch protection

If there is an external danger, or if ice on the windows, etc., prevents you from closing the windows normally, proceed as follows:

1. Pull the switch past the resistance point and hold it there. Pinch protection is limited and the window reopens slightly if the closing force exceeds a certain value.
2. Pull the switch again past the resistance point within approx. 4 seconds and hold it there. The window closes without pinch protection.

Safety switch



With the safety switch, you can prevent the rear windows from being opened or closed via the switches in the rear passenger area, by children, for example. When the safety function is switched on, the LED comes on.

 Always press the safety switch when children ride in the rear, otherwise unchecked closing of the windows could lead to injuries. ◀

Sedan: Glass sunroof*, electric

 To prevent injuries, exercise care when closing the glass sunroof and keep it in your field of vision until it is shut. Take the remote control with you when you leave the car, otherwise children could operate the sunroof and possibly injure themselves. ◀



Raising

Press the switch.

- ▷ The closed glass sunroof is raised and the sliding visor opens slightly.

- ▷ The open glass sunroof automatically travels into the raised position. The sliding visor remains completely open.

Opening, closing

- ▷ Press the switch backwards to the resistance point.
The glass sunroof and the sliding visor open together as long as you hold the switch in this position.
- ▷ Push the switch backwards past the resistance point.
The glass sunroof and the sliding visor open automatically. Briefly press the switch again to stop the opening movement.

You can close the glass sunroof in a similar manner by pushing the switch forwards. The sliding visor remains open and can be closed by hand.

For information on convenient operation via the remote control or door lock, refer to page 30 or 31.

After switching off the ignition

When the remote control is removed or the ignition is switched off, you can still operate the sunroof for approx. 1 minute as long as no door has been opened.

Pinch protection system

If the glass sunroof encounters an obstruction during closing from approximately the middle of the opening in the roof, or during closing from the raised position, the closing movement is interrupted and the glass sunroof is opened again slightly.

 Despite the pinch protection system check and clear the sunroof's travel path prior to closing it, otherwise the safety system might fail to detect certain kinds of obstructions, such as very thin objects, and the sunroof would continue closing. ◀

Closing without pinch protection

If there is an external danger, push the switch past the resistance point and hold it there. The roof closes without pinch protection.

Following interruptions in electrical power supply

After a power failure, there is a possibility that the glass sunroof can only be raised. The system must be initialized. BMW recommends having this work done by your BMW center.

Closing manually

In the event of an electrical malfunction, you can move the glass sunroof manually:

1. Unclip the front of the cover of the interior lamps using the screwdriver from the onboard tool kit, refer to page 221.



2. Insert the screwdriver into the openings on each side to press the clips.



3. Remove the control unit.
4. Unplug the motor. Considerably less effort will be required for manual operation.

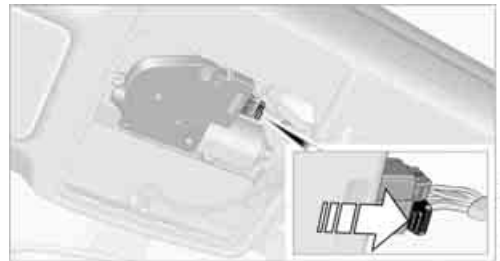

5. Insert the Allen wrench supplied with the onboard tool kit, refer to page 221, into the opening provided. Move the glass sunroof in the desired direction.



6. Reinstall the control unit and reattach the lamp cover.

Sports Wagon: Panorama glass roof*

⚠ To prevent injuries, exercise care when closing the panorama glass roof and keep it in your field of vision until it is shut. Take the remote control with you when you leave the car, otherwise children could operate the sunroof and possibly injure themselves. ◀



Raising

- ▷ Press the switch.
The closed panorama glass roof is raised and the sliding visor opens slightly.
- ▷ Press the switch twice.
The open panorama glass roof is raised and the sliding visor is opened completely.

⚠ Do not close the sliding visor forcibly with the roof in the raised position, as this would damage the mechanism. ◀

Opening, closing

Sliding visor

The sliding visor can be opened or closed separately when the sunroof is closed or raised.

- ▷ Press the switch backwards to the resistance point.
The sliding visor opens as long as you keep the switch in this position.
- ▷ Press the switch backwards past the resistance point.
The sliding visor will open automatically. Briefly press the switch again to stop the movement.

You can close the sliding visor in a similar manner by pressing the switch forwards.

Comfort position

In the comfort position, the sunroof is not completely open, thus reducing wind noise in the passenger compartment.

Each time the panorama glass roof is opened or closed, it stops in the comfort position. If desired, continue the movement by pressing the switch.

Panorama glass roof

- ▷ With the sliding visor open, press the switch backwards again to the resistance point.
The panorama glass roof opens as long as you keep the switch in this position.
- ▷ With the sliding visor open, press the switch backwards again beyond the resistance point.
The panorama glass roof opens automatically. Briefly press the switch again to stop the movement.

You can close the panorama glass roof in a similar manner by pressing the switch forwards.

For information on convenient operation via the remote control or door lock, refer to page 30 or 31.

Opening and closing the sunroof and sliding visor at the same time

Press the switch twice in quick succession beyond the resistance point. Pressing the switch again stops the operation.

After switching off the ignition

When the remote control is removed or the ignition is switched off, you can still operate the sunroof for approx. 1 minute as long as no door has been opened.

Pinch protection system

If the panorama glass roof or the sliding visor encounters an obstruction while closing from a position about two-thirds closed, or during closing from the raised position, the closing movement is interrupted and the panorama glass roof and the sliding visor are opened again slightly.

 Despite the pinch protection system check and clear the sunroof's travel path prior to closing it, otherwise the safety system might fail to detect certain kinds of obstructions, such as very thin objects, and the sunroof would continue closing. ◀

Closing without pinch protection

If there is an external danger, push the switch past the resistance point and hold it there. The roof closes without pinch protection.

Following interruptions in electrical power supply

After a power failure, there is a possibility that the panorama glass roof can only be raised. The system must be initialized. BMW recommends having this work done by your BMW center.

Closing manually

In the event of an electrical malfunction, you can move the panorama glass roof manually:

1. Unclip the front of the cover of the interior lamps using the screwdriver from the onboard tool kit, refer to page 221.

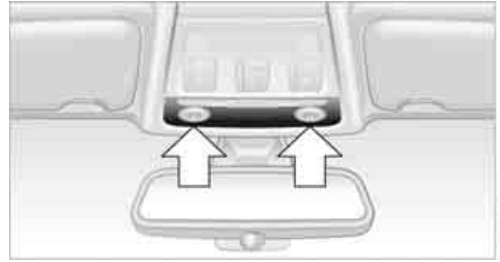

2. Insert the screwdriver into the openings on each side to press the clips.



3. Remove the control unit.
4. Unplug the motor. Considerably less effort will be required for manual operation.

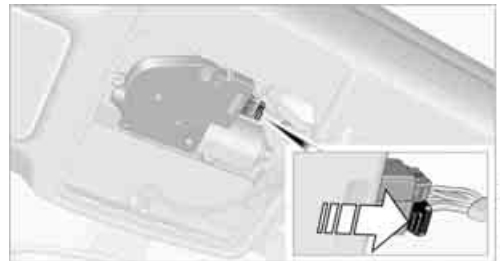

5. Insert the Allen wrench supplied with the onboard tool kit, refer to page 221, into the

opening provided. Move the panorama glass roof in the desired direction.

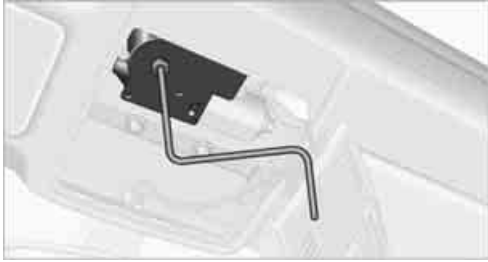

6. Reinstall the control unit and reattach the lamp cover.

Adjustments

Sitting safely

The ideal sitting position can make a vital contribution to relaxed, fatigue-free driving. In conjunction with the safety belts, the head restraints and the airbags, the seated position has a major influence on your safety in the event of an accident. To ensure that the safety systems operate with optimal efficiency, we strongly urge you to observe the instructions contained in the following section.

For additional information on transporting children safely, refer to page 53.

Airbags



Always maintain an adequate distance between yourself and the airbags. Always grip the steering wheel on the rim, with your hands in the 3 o'clock and 9 o'clock positions, to minimize the risk of injury to the hands or arms in the event of the airbag being triggered off.

No one and nothing is to come between the airbags and the seat occupant.

Do not use the cover of the front airbag on the front passenger side as a storage area. Make sure that the front passenger is sitting correctly, e.g. not resting feet or legs on the dashboard, otherwise leg injuries can occur if the front airbag is triggered.

Make sure that passengers do not lean their heads against the side or head airbags, otherwise serious injuries could result if the airbags suddenly deployed. ◀

Even if you follow all the instructions, injuries resulting from contact with airbags cannot be fully excluded, depending on the circumstances. The ignition and inflation noise may provoke a mild hearing loss in extremely sensitive individuals. This effect is usually only temporary.

For airbag locations and additional information on airbags, refer to page 95.

Head restraint

A correctly adjusted head restraint reduces the risk of neck injury in the event of an accident.



Adjust the head restraint in such a way that its center is at approx. ear level. Otherwise, there is an increased risk of injury in the event of an accident. ◀

Head restraints, refer to page 46.

Safety belt

Before every drive, make sure that all occupants wear their safety belts. Airbags complement the safety belt as an additional safety device, but they do not represent a substitute.

Your vehicle has five seats, each of which is equipped with a safety belt.



Never allow more than one person to wear a single safety belt. Never allow infants or small children to ride in a passenger's lap. Make sure that the belt in the lap area sits low across the hips and does not press against the abdomen.

The safety belt must not rest against the throat, run across sharp edges, pass over hard or fragile objects or be pinched. Fasten the safety belt so that it sits as snugly as possible against the lap and shoulder without being twisted. Otherwise the belt could slide over your hips and injure your abdomen in the event of a frontal collision.

Avoid wearing bulky clothing and regularly pull the belt in the upper-body area taut, otherwise its restraining effect could be impaired.

Sports Wagon: if the rear center safety belt is used, the wider backrest must be locked in place, refer to page 115. Otherwise the safety belt will have no restraining effect. ◀

Safety belts, refer to page 49.

Seats

Note before adjusting

⚠ Never attempt to adjust your seat while the vehicle is moving. The seat could respond with unexpected movement, and the ensuing loss of vehicle control could lead to an accident.

On the front passenger seat as well, do not incline the backrest too far to the rear while the vehicle is being driven, otherwise there is a danger in the event of an accident of sliding under the safety belt, eliminating the protection normally provided by the belt. ◀

Comply with the instructions on head restraint height on page 46, and on damaged safety belts on page 50.

Manual adjustment

⚠ Observe the adjustment instructions on page 45 to ensure the best possible personal protection. ◀

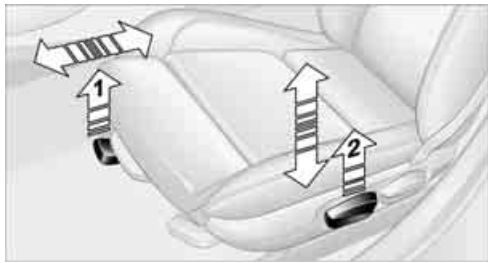

Longitudinal direction

Pull lever **1** and slide the seat to the desired position. After releasing the lever, move the seat gently forward or back to make sure it engages properly.

Height

Pull lever **2** and apply your weight to the seat or lift it off, as necessary.

Backrest

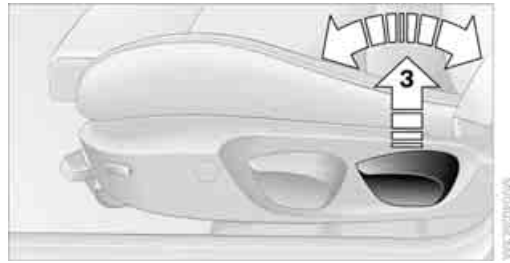

Pull lever **3** and apply your weight to the backrest or lift it off, as necessary.

Tilt*

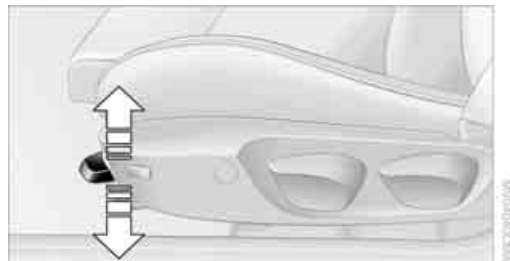

Pull the lever and apply your weight to the seat or lift it off, as necessary.

Thigh support*

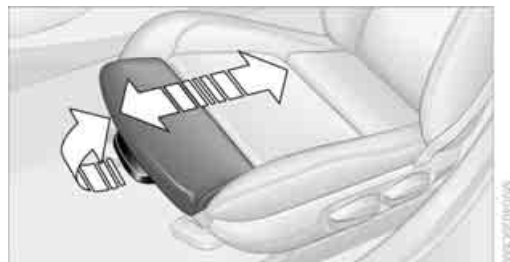

Pull the lever and move the thigh support forward or back.

Electrical adjustment

⚠ Observe the adjustment instructions on page 45 to ensure the best possible personal protection. ◀

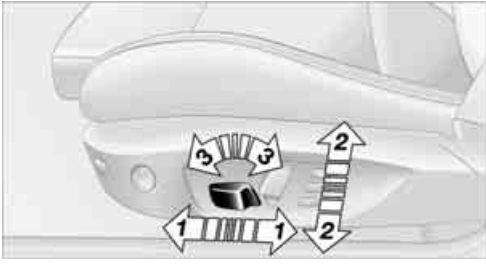

- 1 Longitudinal direction
- 2 Height
- 3 Angle



4 Backrest

The head restraints are adjusted manually, refer to Head restraints below.

Lumbar support*



You can also adjust the contour of the backrest to obtain additional support in the lumbar region.

The upper hips and spinal column receive supplementary support to help you maintain a relaxed, upright sitting position.

- ▷ Increase or decrease curvature: press the switch at the front or rear, respectively.

- ▷ Shift curvature up or down: press the switch at the top or bottom, respectively.

Backrest width*



You can change the width of the backrest to suit your individual preferences by adjusting the lateral-support pads.

Press the front or rear end of the switch. Backrest width decreases or increases accordingly.

Head restraints

A correctly adjusted head restraint reduces the risk of neck injury in the event of an accident.

- ⚠ Adjust the head restraint in such a way that its center is at approx. ear level. Otherwise, there is an increased risk of injury in the event of an accident. Only remove a head restraint if no one will be sitting on the seat in question. Reinstall the head restraint before transporting anyone on that seat. Otherwise, the passenger will be without protection from the head restraint. ◀

Front seats

Height adjustment

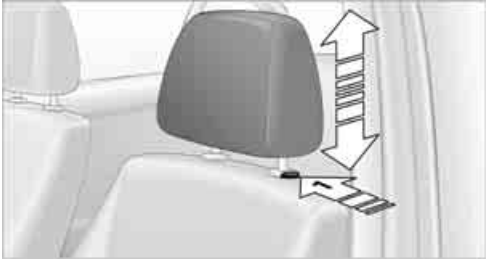

- ▷ To raise: pull up.
- ▷ To lower: press the button, arrow **1**, and slide the head restraint down.

Removing

1. Pull up as far as it will go.
2. Press the button, arrow **1**, and pull the head restraint all the way out.

Rear seats

Height adjustment

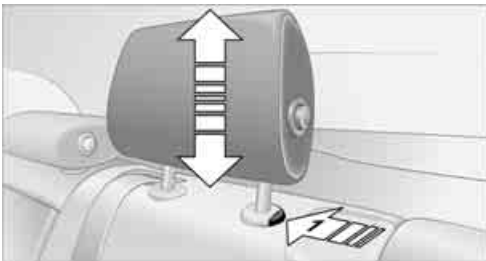

- ▷ To raise: pull up.
- ▷ To lower: press the button, arrow **1**, and slide the head restraint down.

The center head restraint is not height-adjustable.

Removing

Sedan:

Only with through-loading system:

1. Pull up as far as it will go.
2. Press the button, arrow **1**, tilt the rear seat backrest slightly forward and pull the head restraint all the way out.

▶ Only remove the head restraints if no passengers will be sitting in the rear. Reinstall head restraints before transporting passengers in the rear. ◀

Folding head restraints down and back up

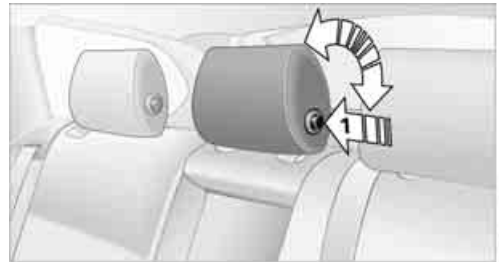

Folding down:

Press the button, arrow **1**.

Folding up:

Pull the head restraint.

Sedan:

Depending on the equipment version, it may be possible to fold down the outer rear head restraints as well.

▶ Only fold the head restraints down if no passengers will be sitting in the rear. Fold up the head restraints before transporting passengers in the rear. ◀

Heated seats*



Press once for each temperature level.
Three LEDs indicate the highest temperature.

To switch off:
Press button longer.

If you continue driving within approx. the next 15 minutes, the seat heating is automatically activated at the previously set temperature.

Seat and mirror memory*

You can store and call up two different combinations of driver's-seat and exterior-mirror positions.

Settings for the backrest width and lumbar support are not stored in memory.

Storing

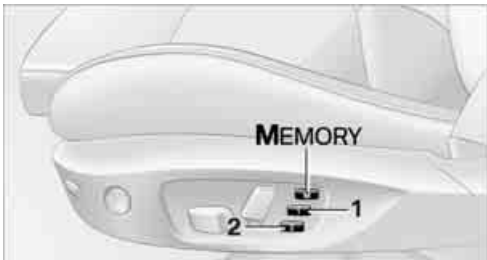

1. Switch on radio readiness or the ignition, refer to page 57.
2. Adjust the seat and exterior mirrors to the desired positions.
3. Press the **M** button.
The LED in the button lights up.
4. Press the desired memory button **1** or **2**: the LED goes out.

The driver's seat and exterior mirror positions are stored for the remote control currently in use.

Call-up

! Do not call up memory while you are driving, otherwise unexpected seat movement could result in an accident. ◀

Convenience mode

1. Unlock and open the driver's door or switch on radio readiness, refer to page 57.
2. Briefly press the desired memory button **1** or **2**.

The adjusting procedure is halted immediately when you touch a seat adjustment switch or one of the memory buttons.

Safety feature

1. Close the driver's door and switch the ignition on or off, refer to page 57.
2. Press the desired memory button **1** or **2** and keep it pressed until the adjustment process has been completed.

If the **M** button was pressed accidentally: Press the button again; the LED goes out.

Call-up with the remote control

The driver's seat position last stored is stored for the remote control currently in use.

You can select the occasion on which the seat is reset to that position.

- ▷ Call-up when the vehicle is unlocked
- ▷ Call-up when the driver's door is opened.

! When this Personal Profile function is used, first make sure that the footwell behind the driver's seat is free of obstacles. Failure to do so could cause injury to persons or damage to objects as a result of a rearward movement of the seat. ◀

The adjusting procedure is halted immediately when you touch a seat adjustment switch or one of the memory buttons.

Selecting automatic call-up

iDrive, for operating principle refer to page 16.

1. Open the start menu.
2. Press the controller to open the **i** menu.
3. Select "Settings" and press the controller.
4. Select "Vehicle / Tires" and press the controller.
5. If necessary, move the highlight marker to the uppermost field. Turn the controller until "Door locks" is selected and press the controller.

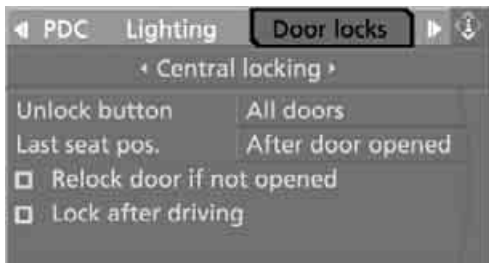

6. Select "Central locking" and press the controller.
7. Select "Last seat pos." and press the controller.
8. Select "After unlocking" or "After door opened".



9. Press the controller.

Switching off automatic call-up

Select "Deactivated" and press the controller.

Safety belts



Observe the adjustment instructions on page 45 to ensure the best possible personal protection. ◀

Before every drive, make sure that all occupants wear their safety belts. Airbags complement the safety belt as an additional safety device, but they do not represent a substitute.

On the rear seats, the center belt buckle marked with the letters CENTER is solely intended for the center passenger.



Closing

Make sure you hear the latch plate engage in the belt buckle.

The upper belt anchor is suitable for adults of any stature as long as the seat is adjusted properly, refer to page 45.

Opening

1. Grasp the belt firmly.
2. Press the red button in the buckle.
3. Guide the belt into its reel.

'Fasten safety belts' reminder for front seats



The indicator lamp comes on and an acoustic signal sounds. In addition, a message will appear on the Control Display. Check whether the safety belt has been fastened correctly.

The 'Fasten safety belts' reminder is issued as long as the driver's safety belt has not been fastened. The 'Fasten safety belts' reminder is also activated at road speeds above approx. 5 mph or 8 km/h if the front passenger's safety belt is

not fastened, if heavy objects are placed on the front passenger seat, or if driver or front passenger unfasten their safety belts.

Damage to safety belts

 If the safety belts are damaged or stressed in an accident: have the belt system, including any belt tensioners or child-restraint systems, replaced and the belt anchors checked. Have this work done only by your BMW center or at a workshop that works according to BMW repair procedures with correspondingly trained personnel. Otherwise, it is not guaranteed that the safety devices will function properly. ◀

Mirrors

Exterior mirrors

The front passenger's mirror is more convex than the driver's mirror. The objects seen in the mirror are closer than they appear. Do not gauge your distance from traffic behind you on the basis of what you see in the mirror; otherwise there is an increased risk of an accident. ◀

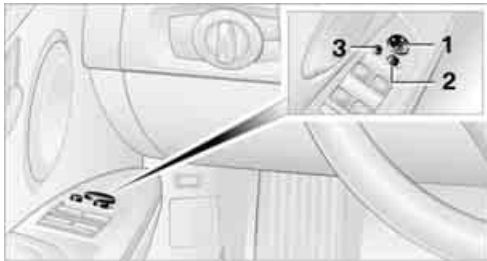

- 1 Adjustments
- 2 Switching to the other mirror or automatic curb monitor*
- 3 Folding mirrors in and out*

The settings for the exterior mirrors are stored for the remote control currently in use*, refer to Personal Profile, page 28. The stored positions are called up automatically when the vehicle is unlocked.

Manual adjustment

The mirrors can also be adjusted manually: press the edge of the glass.

Folding mirrors in and out*

At driving speeds up to approx. 12 mph/ 20 km/h, you can fold the mirrors in and out by pressing button **3**. This can be beneficial in narrow streets, for example, or for moving mirrors that were folded in by hand back out into their correct positions. Mirrors that were folded in are folded out automatically at a speed of approx. 25 mph/40 km/h.

 Before entering an automatic car wash, fold in the exterior mirrors by hand or with button **3**, to prevent them from being damaged due to the width of the vehicle. ◀

Automatic heating*

At outside temperatures below a certain limit, both exterior mirrors are automatically heated while the engine is running or the ignition switched on.

Passenger-side mirror tilt function – automatic curb monitor*

Activating

1. Push the switch to the position for the driver's-side mirror, arrow 1.

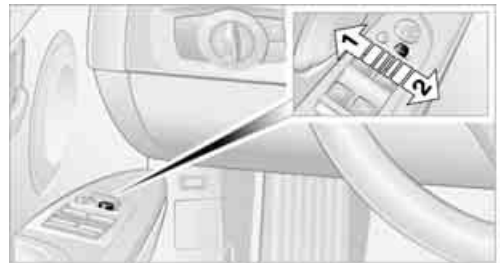

2. Engage reverse gear or move the selector lever to position R.
The glass of the mirror on the passenger side tilts slightly down. This allows the driver to see the area immediately adjacent to the vehicle, e.g. a curb, when backing into a parking space.

Deactivating

Push the switch to the position for the passenger-side mirror, arrow 2.

Interior rearview mirror



Turn the knob to reduce glare from the headlights of cars behind you when driving at night.

Interior and exterior mirrors, automatic dimming feature*

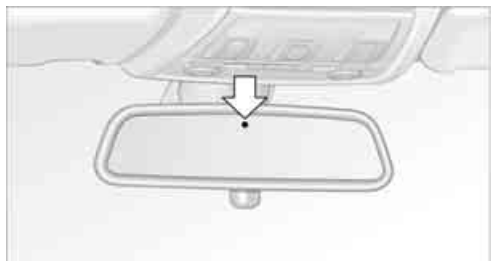

The automatic dimming feature of the interior and exterior mirrors* is controlled by two photo cells in the interior rearview mirror. One photo cell is in the mirror frame, see arrow; the other is on the back of the mirror.

In order to ensure that the system functions correctly, keep the photo cells clean, do not cover the area between the interior rearview mirror and windshield, and do not affix adhesive labels or stickers of any kind to the windshield directly in front of the mirror.

Steering wheel

Adjustments

 Do not adjust the steering wheel position while the car is in motion, otherwise there is a risk of accident due to an unexpected movement. ◀

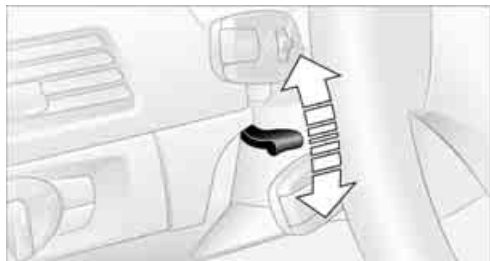

1. Fold the lever down.
2. Move the steering wheel to the preferred height and angle to suit your seated position.
3. Swing the lever back up.

 Do not use force to swing the lever back up, otherwise the mechanism will be damaged. ◀

Electric steering wheel lock

The steering wheel locks or unlocks automatically when the remote control is removed or inserted, refer to page 57.

Programmable buttons on the steering wheel

You can program the buttons to suit your personal preferences:



These settings are stored for the remote control currently in use.

iDrive, for operating principle refer to page 16.

1. Press the **MENU** button.
This opens the start menu.
2. Press the controller to open the **i** menu.
3. Select "Settings" and press the controller.



4. Select "Steering wheel buttons" and press the controller.



A list showing various functions is displayed:

- ▷ "Navigation voice instructions"
Voice messages from the navigation system*
- ▷ "Air recirculation on / off"
Permanent shut-off of outside air, refer to Automatic recirculated-air control AUC on page 103
- ▷ "Mute on / off"
To mute the audio sources
- ▷ "Monitor on / off"
To switch the Control Display on/off
- ▷ "Telephone list"*
To show/hide the phone book or last displayed list of stored phone numbers
- ▷ "Next entertainment source"
To change the audio source

5. Select the desired function and press the controller.
6. Select a button, if appropriate, and press the controller.

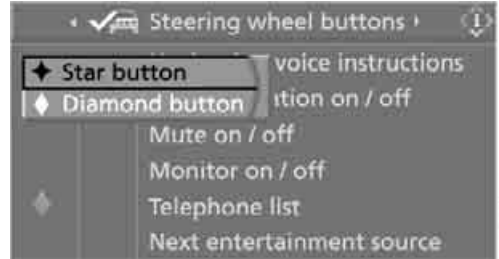

You can operate the selected function using the corresponding button.

Operating a function

Briefly press the appropriate button on the steering wheel.

If you have programmed "Navigation voice instructions" for one of the buttons:

- ▷ Switch voice instructions on/off:
Press the button for a longer period
- ▷ To repeat the last voice instruction:
Press the button briefly
- ▷ To cancel a voice instruction during an announcement:
Press the button briefly

Transporting children safely

The right place for children

 Do not leave children unattended in the vehicle, otherwise they could endanger themselves and/or other persons by opening the doors, for example. ◀

The rear center seat is not suitable for installing universal child-restraint systems for all age groups, approved for the age group in question.

Children always in the rear

Accident research has shown that the safest place for children is on the rear seat.

 Children under the age of 13 or smaller than 5 ft/150 cm may be transported only in the rear in suitable child-restraint systems appropriate for their age, weight and size. Otherwise there is an increased risk of injury in the event of an accident. ◀

Children 13 years of age or older must be buckled in with a safety belt as soon as there no longer is any child-restraint system that is appropriate for their age, size and weight.

The rear seats in your vehicle meet the recommendations of the SAE J1819 standard for safely mounting child-restraint systems in motor vehicles.

Exception for front passenger seat

 Should it be necessary to use a child-restraint system on the front passenger seat, the front and side airbags for the front passenger must be deactivated. Otherwise, a child traveling on that seat will face a significant risk of injury if the airbags are triggered off, even with a child-restraint system. Your BMW center will be glad to advise you. ◀

For more information on automatic deactivation of the front passenger airbags refer to page 95.

Installing child-restraint systems

 Observe the child-restraint system manufacturer's instructions when selecting, installing and using child-restraint systems. Otherwise the protective effect may be diminished. ◀

Standard child-restraint systems are designed to be secured with a lap belt or with the lap-belt section of a lap-and-shoulder belt. Incorrectly or improperly installed child-restraint systems can increase the risk of injury to children. Always follow the installation instructions for the system with the greatest care.

On the front passenger's seat

 Before installing a child-restraint system on the front passenger's seat, make sure that the front and side airbags for the front passenger are deactivated, otherwise there is an increased risk of injury if the airbags deploy. ◀

Backrest width*

 The backrest width of the front passenger's seat must be at its widest possible setting. Do not change the setting after installing the child seat. Otherwise the child seat's stability on the front passenger's seat is limited. ◀

1. Adjust the backrest width to its widest setting, refer to page 46.
2. Install the child seat.

Child seat security



The rear safety belts and the front passenger's safety belt can be prevented from being pulled out in order to fasten child-restraint systems.

To lock the safety belt

1. Secure the child-restraint system with the belt.
2. Pull the belt strap all the way out.
3. Allow the belt strap to retract and pull it taut against the child-restraint system.

The safety belt is locked.

To unlock the safety belt

1. Open the belt buckle
2. Remove the child-restraint system.
3. Allow the safety belt strap to retract all the way.

Child-restraint system with tether strap

Sports Wagon

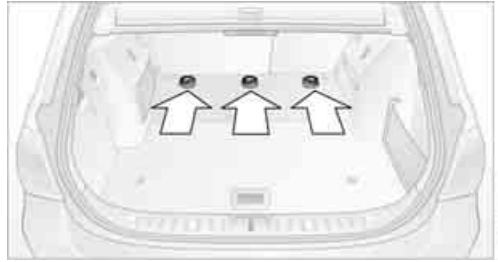

Sedan

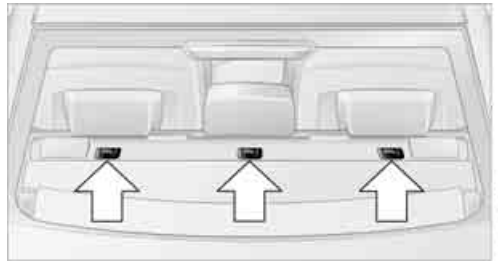

There are three additional anchors for child-restraint systems with tether straps, see arrows.

Placement of the tether strap

Sports Wagon:

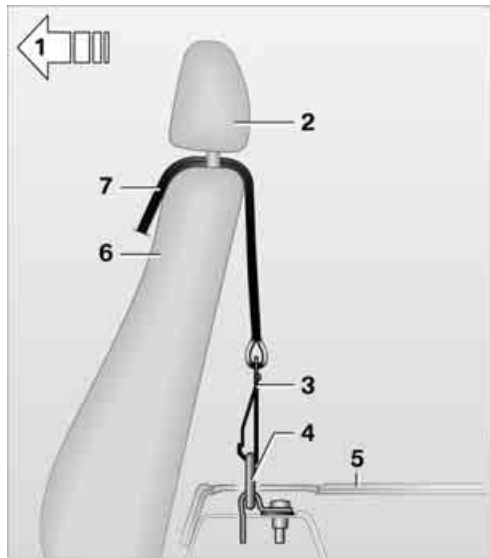

Sedan:

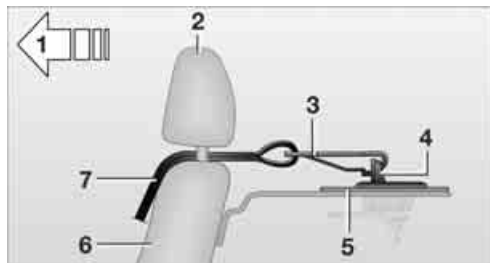

- 1 Forward driving direction
- 2 Head restraint
- 3 Attaching clip
- 4 Child restraint anchor fitting
- 5 Rear window shelf/cargo bay floor
- 6 Seat backrest
- 7 Tether strap

Fold the anchors upward before using them.

1. Push the head restraint upward.
2. Guide the tether strap between the head restraint holders.

3. Use the hook to clip the tether strap to the anchor.
4. Push the head restraint into its lowermost position.
5. Pull the tether strap taut.

LATCH child-restraint fixing system

LATCH: Lower Anchors and Tethers for Children.

 When installing and using LATCH child-restraint systems, comply with the system manufacturer's operating and safety instructions. ◀

Before installing the child seat, pull the belt out of the area for the child-restraint fixing system.

Rear seats with through-loading system



The anchor points for the lower LATCH anchors are located behind the labeled protective caps.

Rear seats without through-loading system

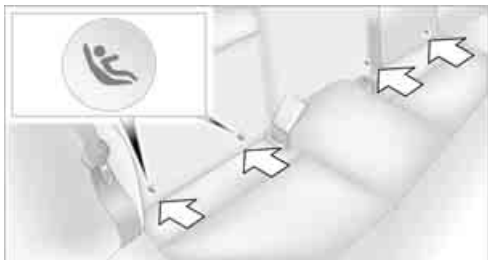

The anchor points for the lower LATCH anchors are located at the positions indicated by arrows, in the gap between the seat and the backrest.

 Make sure that the two lower LATCH anchors are properly engaged and that the child-restraint system rests firmly against the seat backrest. ◀

On journeys

Child-safety locks for rear doors



Slide down the safety lever on the rear door:

The door can now be opened from the outside only.

Safety switch for power windows

Press the safety switch for the power windows, refer to page 39, if children are traveling on the rear seat.

Ignition lock



Insert the remote control all the way into the ignition lock.

- ▶ Radio readiness switches on. Individual electrical consumers can operate.
- ▶ The electric steering wheel lock disengages audibly.

 Insert the remote control into the ignition lock before you move the vehicle, otherwise the electric steering wheel lock will not disengage and you will not be able to steer the car. ◀

Removing the remote control from the ignition lock

Press the remote control in briefly; it is ejected part of the way.

At the same time:

- ▶ The ignition switches off if it was on beforehand.
- ▶ The electric steering wheel lock engages audibly.

Automatic transmission

You cannot take out the remote control unless the selector lever is in the P position: interlock.

Start/stop button



Each time the start/stop button is briefly pressed, radio readiness or the ignition is switched on or off.

-  Briefly pressing the start/stop button while the brake or clutch is depressed starts the engine. ◀

Radio readiness

Individual electrical consumers can operate. The time and the outside temperature are displayed in the instrument cluster, refer to page 72.

Radio readiness is switched off automatically:

- ▶ When the remote control is removed from the ignition lock
- ▶ In cars with convenient access*, by touching the surface above the door lock, refer to Locking on page 37

Ignition on

All electrical consumers can operate. The odometer and trip odometer are displayed in the instrument cluster, refer to page 72.

-  When the engine is off, please turn off the ignition and any unnecessary electrical consumers in order to preserve the battery. ◀

Radio readiness and ignition off

All indicator and warning lamps as well as displays in the instrument cluster go out.

Starting the engine

 Do not run the engine in closed rooms, otherwise the inhalation of toxic exhaust gases can cause unconsciousness and death. The exhaust gases contain carbon monoxide, an odorless and colorless, but highly toxic gas. Never leave an unattended vehicle with the engine running, otherwise such a vehicle represents a potential safety hazard.

Before leaving the car with the engine running, place the transmission in idle or move the selector lever to position P and apply the parking brake to prevent the car from moving. ◀

When starting the engine, do not press the accelerator pedal.

Do not allow the engine to warm up by leaving it running while the vehicle remains stationary. Instead, begin to drive at a moderate engine speed.

 Do not depress either the brake or the clutch until you are ready to start the engine. The engine is started when you briefly press the start/stop button and depress the brake if the car has automatic transmission, or the clutch if the car has manual transmission. ◀



Manual transmission

1. Apply the parking brake.
2. Depress the clutch and shift to idle position.
3. Briefly press the start/stop button.

The starter operates automatically for a certain time, and stops automatically as soon as the engine has started.

Automatic transmission

1. Depress the brake.
2. Move the selector lever to position P or N.
3. Briefly press the start/stop button.

The starter operates automatically for a certain time, and stops automatically as soon as the engine has started.

Special starting conditions

In the following situations, press the accelerator pedal halfway down when starting the engine:

- ▷ If the engine does not start on the first attempt, for instance when it is extremely hot or cold.
- ▷ If the engine is started at very low temperatures, below approx. + 5 °F / -15 °C, at high altitudes above approx. 3,300 ft/1,000 m.

 Avoid frequent starting in quick succession or repeated start attempts in which the engine does not start. Otherwise, the fuel is not burned or inadequately burned and there is a danger of overheating and damaging the catalytic converter. ◀

Switching off the engine

 Always take the remote control with you when you leave the vehicle.

When parking on a downhill incline, apply the parking brake, otherwise the vehicle could roll away. ◀

Manual transmission

1. With the car at a standstill, briefly press the start/stop button.
2. Shift into first gear or reverse.
3. Apply the parking brake.

Automatic transmission

1. With the car at a standstill, move the selector lever to position P.
2. Briefly press the start/stop button.
3. Apply the parking brake.

Parking brake

The parking brake is primarily intended to prevent the vehicle from rolling while parked; it brakes the rear wheels.

Indicator lamp

BRAKE The indicator lamp is lit, and when you drive off an acoustic signal sounds in addition. The parking brake is still applied.

 Indicator lamp for Canadian models.

Applying

The lever locks in position automatically.

Releasing

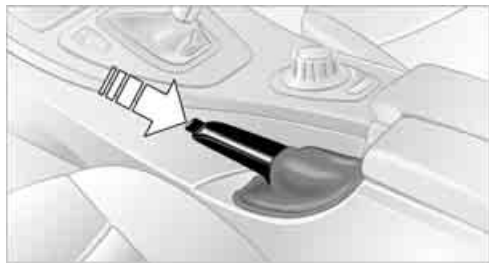

Pull slightly upwards, press the button and lower the lever.

 In exceptional cases, if the parking brake has to be used to slow or stop the car, do not pull the lever up too hard. In doing so, continuously press the button of the parking brake lever.

Otherwise, too violent an application of the parking brake can lock up the rear wheels and cause the rear of the car to swerve. ◀

 To prevent corrosion and one-sided braking action, occasionally apply the parking brake lightly when the vehicle is slowly coming to a stop if the traffic conditions are suitable. The brake lamps do not light up when the parking brake is applied. ◀

Manual transmission

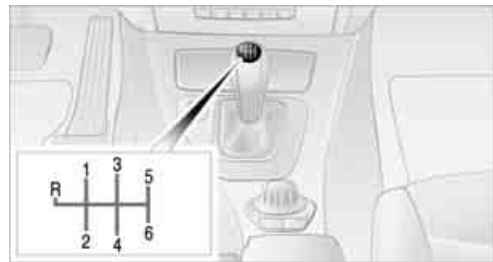

 When shifting into 5th or 6th gear, press the gearshift lever to the right. Otherwise the engine could be damaged if you inadvertently shift into 3rd or 4th gear. ◀

Reverse gear

Select this only when the vehicle is stationary. When the gearshift lever is pressed to the left, a slight resistance has to be overcome.

Automatic transmission with Steptronic*

In addition to fully automatic operation, you can also manually shift with the Steptronic, refer to page 60.

Vehicle parking

 To prevent the vehicle from rolling, always select position P and apply the parking brake before leaving the vehicle with the engine running. ◀

Disengaging the remote control

In order to remove the remote control from the ignition lock, you must first move the selector lever to position P and switch off the engine: interlock.

Selector lever positions

P R N D M/S + -

Displays in the instrument cluster



P R N D S M1 to M6

The selector lever position is displayed, or the current gear in the manual mode.

Changing selector lever positions

- ▷ With the ignition switched on or the engine running, the selector lever can be moved out of position P: interlock.
- ▷ Before moving the lever away from P or N with the vehicle stationary, first depress the brake; otherwise the selector lever will refuse to move: shiftlock.



To prevent the vehicle from creeping after you select a driving position, depress the brake until you are ready to start. ◀



A lock prevents you from inadvertently engaging selector lever positions R and P. To cancel the lock, press the button on the front of the selector lever, refer to arrow.

P Park

Select this only when the vehicle is stationary. The rear wheels are locked.

R Reverse

Select this only when the vehicle is stationary.

N Neutral, idle

You can select this in a car wash, for example. The vehicle can roll.

D Drive, automatic position

Position for normal vehicle operation. All forward gears are selected automatically.

Under normal operating conditions, fuel consumption is lowest when you are driving in position D.

Kick-down

Kick-down enables you to achieve maximum performance.

Press the accelerator pedal beyond the full-throttle resistance point.

Manual operation and Sport program M/S



Move selector lever from position D toward the left into the M/S shifting slot:

The sport program is activated and DS appears in the instrument cluster. This position is recommended for a performance-oriented driving style.

To use the automatic mode again, move the selector lever to the right into position D.

Shifting gears via the selector lever

When you press the selector lever forwards or backwards, the manual mode is activated and Steptronic changes gear. The instrument cluster shows M1 through M6.

Upshifts and downshifts are executed only when they will result in a plausible combination of engine and vehicle speed; thus, for example, a downshift that would cause the engine to overrev will not be executed by the system. The gear selected is briefly displayed in the instrument cluster, followed by the gear actually in use.

Shifting gears via shift paddles* on the steering wheel

The shift paddles allow you to shift gears quickly since both hands can remain on the steering wheel.

- ▷ When you use the shift paddles on the steering wheel to shift gears in automatic mode, the transmission automatically switches to manual mode.
- ▷ If you do not accelerate or shift gears using the shift paddles for a certain amount of time, the transmission automatically switches back to automatic mode.

▷ If the selector lever is in the M/S gear plane, manual mode remains active. ◀

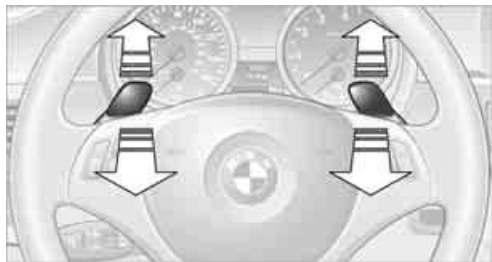

- ▷ To shift up: pull one of the shift paddles.
- ▷ To shift down: press one of the shift paddles.

Upshifts and downshifts are executed only when they will result in a plausible combination of engine and vehicle speed; thus, for example, a downshift that would cause the engine to overrev will not be executed by the system. The gear selected is briefly displayed in the instrument cluster, followed by the gear actually in use.

Overriding selector lever lock

Should the selector lever refuse to move out of position P although the button on the selector lever is pressed, the selector lever lock can be overridden:

1. Unclip the sleeve of the selector lever.
2. Pull the sleeve up over the selector lever until the sleeve is inside out.

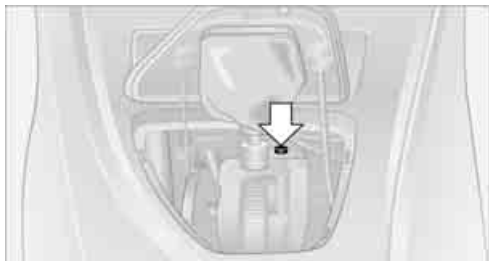

3. Using the screwdriver from the onboard tool kit, refer to page 221, press the red lever while moving the selector lever to the desired position.

Turn signals/headlamp flasher

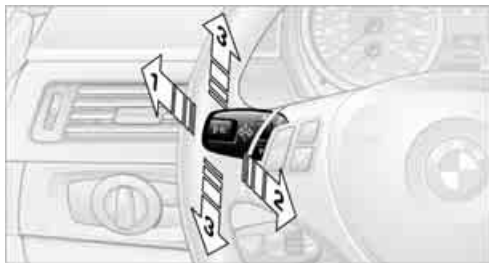

- 1 High beams
- 2 Headlamp flasher
- 3 Turn signals

Using turn signals

Press the lever beyond the resistance point.

To turn off manually, press the lever to the resistance point.

 Unusually rapid flashing of the indicator lamp indicates that a turn signal indicator has failed. ◀

Indicating a turn briefly

Press the lever as far as the resistance point for as long as you wish to indicate a turn.

Triple turn signal activation

Press the lever as far as the resistance point. The turn signals flash three times.

You can activate or deactivate this function.

iDrive, for operating principle refer to page 16.

1. Open the start menu.
2. Press the controller to open the **i** menu.
3. Select "Settings" and press the controller.
4. Select "Vehicle / Tires" and press the controller.
5. If necessary, move the highlight marker to the uppermost field. Turn the controller until "Lighting" is selected and press the controller.



6. Select "Triple turn signal" and press the controller.
 - Triple turn signaling is activated.

Wiper system

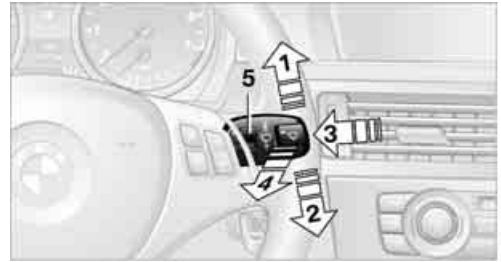

- 1 Switching on wipers
- 2 Switching off wipers or brief wipe
- 3 Activating/deactivating intermittent wipe or rain sensor*
- 4 Cleaning windshield and headlamps*
- 5 Setting speed for intermittent wipe, or sensitivity of the rain sensor

Switching on wipers

Press the lever upward, arrow 1.

The lever automatically returns to its initial position when released.

Normal wiper speed

Press once.

The system switches to operation in the intermittent mode when the vehicle is stationary.

Fast wiper speed

Press twice or press beyond the resistance point.

The system switches to normal speed when the vehicle is stationary.

Intermittent wipe or rain sensor*

If the car is not equipped with a rain sensor, the intermittent-wipe time is a preset.

If the car is equipped with a rain sensor, the time between wipes is controlled automatically and depends on the intensity of the rainfall. The sensor is mounted on the windshield, directly in front of the interior rearview mirror.

Activating intermittent wipe or rain sensor

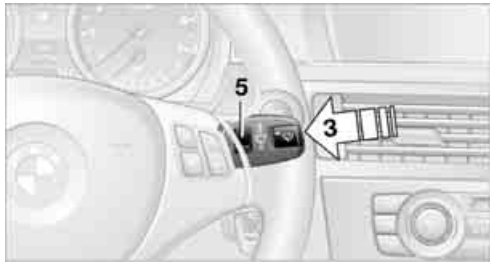

Press the button, arrow **3**. The LED in the button lights up.

Setting speed for intermittent wipe or sensitivity of the rain sensor

Turn knurled wheel **5** up or down.

Deactivating intermittent wipe or rain sensor

Press the button again, arrow **3**. The LED goes out.

 Deactivate the rain sensor before entering an automatic car wash. Failure to do so could result in damage caused by undesired wiper activation. ◀

Cleaning windshield and headlamps*

Pull the lever, arrow **4**.

Washer fluid is sprayed onto the windshield and the wipers are operated for a short time.

When the vehicle lighting system is switched on, the headlamps are cleaned at regular and appropriate intervals.

 Do not use the washers if there is any danger that the fluid will freeze on the windshield. If you do, your vision could be obscured. Antifreeze should therefore be added to the fluid, refer to Washer fluid. Do not use the washers when the washer fluid reservoir is empty, otherwise you will damage the washer pump. ◀

Windshield washer nozzles

The windshield washer nozzles are heated automatically while the engine is running or the ignition is switched on*.

Sports Wagon: rear window wiper



1 Intermittent operation. When reverse gear is engaged, the system switches to continuous operation.

2 Cleaning the rear window

The rear window wiper does not move if the lever is in position 1 before the ignition is switched on.

To switch on the rear window wiper:

1. Move the lever to its home position.
2. Reselect the desired position.

 Do not use the washers when the washer fluid reservoir is empty, otherwise you will damage the washer pump. ◀

Washer fluid

 Washer fluid antifreeze is flammable. Always keep it well away from sparks and open flames, and store it in the tightly closed original container, well out of the reach of children. Comply with the instructions on the container. ◀

Washer fluid reservoir

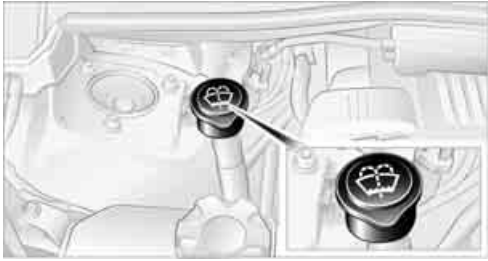

Fill with water and, if required, with a washer antifreeze, according to manufacturer's recommendations.

All washer nozzles are supplied with washer fluid by the same reservoir.

 Mix the water and antifreeze before filling the washer fluid reservoir to make sure the correct concentration is maintained. ◀

Capacity

Approx. 6.3 US quarts/6 liters.

Cruise control*

The concept

Cruise control is available for use at speeds of approx. 20 mph or 30 km/h. The car then stores and maintains the speed that you specify using the lever on the steering column. In order to maintain the specified speed, the system brakes the vehicle when the engine braking effect is insufficient on downhill gradients.

 Do not use cruise control when driving at constant speed is prevented by adverse conditions, e.g. winding roads, dense traffic or poor road conditions due to, e.g., snow, rain, ice or loose surfaces. Otherwise you could lose control of the vehicle and cause an accident as a result. ◀

Manual transmission

You can shift gears while cruise control is activated. An indicator lamp notifies you that you should shift gears when you drive for an

extended period at very high or very low engine speeds, or the system is deactivated.

One lever for all functions

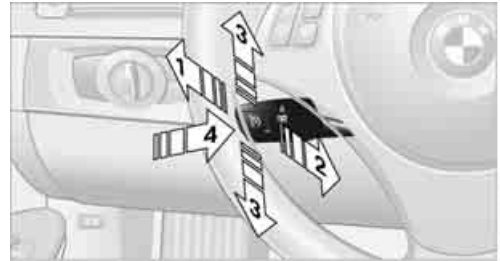

- 1 Storing and maintaining speed or accelerating
- 2 Storing and maintaining speed or decelerating
- 3 Deactivating cruise control
- 4 Resuming a speed stored beforehand

Maintaining current speed

Tap the lever, arrow 1, or pull it briefly, arrow 2. The car's current speed is stored and maintained. It is displayed in the speedometer and briefly in the instrument cluster.

On uphill gradients, it may prove impossible to maintain the set speed if current engine power output is insufficient. If the engine braking effect is insufficient on downhill slopes, the system will brake the vehicle slightly.

Increasing desired speed

Repeatedly press the lever to the resistance point or beyond, arrow 1, until the desired speed is reached.

- ▷ Each time the lever is pressed to the resistance point, the desired speed is increased by approx. 1 mph or 1 km/h.
- ▷ Each time the lever is pressed beyond the resistance point, the desired speed is increased by up to 5 mph or 10 km/h.

The system stores and maintains the speed.

Accelerating using the lever

Accelerating slightly:

Press the lever to the resistance point, arrow **1**, until the desired speed is reached.

Accelerating significantly:

Press the lever beyond the resistance point, arrow **1**, until the desired speed is reached.

The vehicle accelerates without pressure on the accelerator pedal. The system stores and maintains the speed.

Decreasing desired speed

Repeatedly pull the lever to the resistance point or beyond, arrow **2**, until the desired speed is displayed.

- ▷ Each time the lever is pulled to the resistance point, the desired speed is decreased by approx. 1 mph or 1 km/h.
- ▷ Each time the lever is pulled beyond the resistance point, the desired speed is reduced by up to 5 mph or 10 km/h until the minimum speed of 20 mph or 30 km/h is achieved.

The system stores and maintains the speed.

 If the speed is to be reduced significantly, depress the brake; otherwise, deceleration may be insufficient and dangerous situations could result. ◀

Deactivating cruise control

Tap the lever upwards or downwards, arrow **3**. The displays in the speedometer disappear.

In addition, the system is automatically deactivated:

- ▷ When you brake the vehicle
- ▷ When you switch gears very slowly or shift to idle in cars with manual transmission
- ▷ When you select the automatic transmission's neutral position N
- ▷ When you activate DTC or deactivate DSC
- ▷ When DSC or ABS is intervening

Cruise control is not deactivated by depressing the accelerator pedal. Once the accelerator pedal is released, the stored speed is achieved again and maintained.

Warning lamp



The warning lamp comes on when cruise control has been automatically deactivated by applying the parking brake or as a result of DSC intervening. A message appears on the Control Display.

Resuming a speed stored beforehand

Briefly press the button, arrow **4**. the stored speed is resumed and maintained.

In the following instances, the stored speed is deleted and can no longer be resumed:

- ▷ When driving stability control systems are intervening
- ▷ In cars with manual transmission: when you shift gears very slowly or shift to idle position
- ▷ In cars with automatic transmission: when you engage selector lever position N
- ▷ When the ignition is switched off

Displays in the instrument cluster



1 Stored speed

2 Selected speed is displayed briefly

 If --- mph or --- km/h temporarily appears in the instrument cluster display, it is possible that the system prerequisites for operation are currently not met.

Calling up Check Control messages, refer to page **83**. ◀

Malfunction



The warning lamp comes on when the system has failed. A message appears on the Control Display. You can find more information starting on page **82**.

Active cruise control*

The concept

With active cruise control, you can select a desired speed which is not only automatically maintained when driving on open roadways, but also varied to maintain a selected distance setting as slower traffic is encountered.

Active cruise control is a technological advance over the familiar cruise control and is a welcome relief from the constant adjustment of speed that can accompany driving in traffic on highways or other high-speed thoroughfares. Especially on longer trips, the system can reduce fatigue and tension, while increasing your enjoyment of driving. Please use it safely and responsibly.

Within the limits of its capability, the system automatically adapts the car's speed to that of a slower vehicle in front of you. You can specify the distance to be maintained from the vehicle in front in four stages. For safety reasons, the distance is speed-dependent. Based on your selected distance setting, the system automatically decreases the throttle setting and lightly applies the brakes if necessary. The vehicle brake lamps will automatically illuminate to signal a following driver to take action. In addition, it may be necessary for the vehicle or the driver to downshift, depending on the kind of transmission your vehicle is equipped with, to maintain the distance setting selected. If the vehicle ahead speeds up or when the lane ahead becomes clear, your vehicle will accelerate to the speed you have selected by increasing the throttle setting and shifting gears automatically or by the driver as needed. Your selected speed will be held when driving downhill, too.

Since this active cruise control system is a new technology and operates differently from conventional cruise control systems which you may be accustomed to, you are strongly urged to read all of the pages relating to this system before use. Pay special attention to the System limitations section beginning on page 69.

Braking sensation

- ▷ If you step on the brake pedal while the system is braking, pedal sensation will be slightly different from the usual.
- ▷ Possible noises during automatic braking are normal.

Manual transmission

You can shift gears while cruise control is activated. An indicator lamp notifies you that you should shift gears when you drive for an extended period at very high or very low engine speeds, or the system is deactivated.

Range of applications

The minimum desired speed is 20 mph or 30 km/h, the maximum desired speed is 110 mph or 180 km/h.



As with conventional cruise control systems, active cruise control in no way diminishes or substitutes for the driver's own personal responsibility, alertness and awareness in adjusting speed, braking or otherwise controlling the vehicle. The driver should decide when to use the system on the basis of road, traffic, visibility, and weather conditions. Active cruise control is intended for use on highway-type roadways where traffic is moving relatively smoothly. Do not use this system in city driving; heavy traffic such as during rush hour; on curvy, winding roads, slippery roads or roads with sharp curves such as highway off-ramps; during inclement weather such as snow, strong rain or fog; or when entering interchanges, service/parking areas or toll booths. It is also important to regulate your vehicle's speed and distance setting within applicable legal limits. Always be ready to take action or apply the brakes if necessary, especially when the system is actively following a vehicle in front of you. Otherwise driving situations could result that pose the risk of accidents. ◀

One lever for all functions

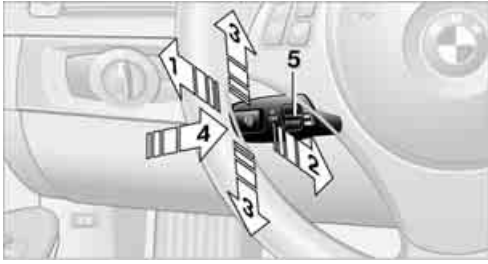

- 1 Store and increase desired speed
- 2 Store and decrease desired speed
- 3 Deactivate system, refer to page 68
- 4 Resume stored desired speed and distance, refer to page 68
- 5 Select distance to vehicle driving ahead, refer to page 67

Maintaining current speed

Briefly press the lever, arrow 1, or briefly pull it, arrow 2, at a driving speed of more than approx. 20 mph or 30 km/h.



The car's current speed is stored and maintained. It is displayed in the speedometer and briefly in the instrument cluster.

Increasing desired speed

Press or tap the lever to the resistance point or beyond, arrow 1, until the desired speed is displayed.

- ▷ Each time the lever is tapped to the resistance point, the desired speed is increased by approx. 1 mph or 1 km/h.
- ▷ Each time the lever is tapped beyond the resistance point, the desired speed is increased by up to 5 mph or 10 km/h until

the maximum speed of 110 mph or 180 km/h is achieved.

The speed then displayed is stored and achieved on a clear road.

Decreasing desired speed

Pull the lever, arrow 2, until the desired speed is displayed.

The other functions work analogously to those described under Increasing desired speed.

Selecting distance

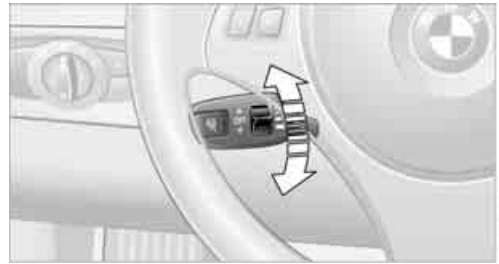

- ▷ Press downward: Increase distance
- ▷ Press upward: Decrease distance.

The selected distance is displayed in the instrument cluster.



Distance 1



Distance 2



Distance 3

This distance is always set when the system is used for the first time after starting the engine.



Distance 4

⚠ Use good judgment to select the appropriate following distance given road conditions, traffic, applicable laws and driving recommendations for safe following distance. Otherwise, an accident risk could result. ◀

Deactivating cruise control

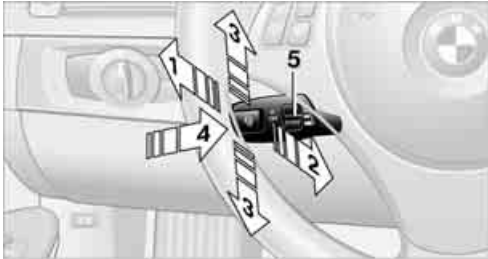

Press the lever upward or downward, arrow **3**. The displays in the speedometer disappear.

In addition, the system is automatically deactivated:

- ▷ When you brake the vehicle
- ▷ When the speed is reduced to below 20 mph or 30 km/h due to a traffic situation
- ▷ When you switch gears very slowly or shift to idle in cars with manual transmission
- ▷ When you select the automatic transmission's neutral position N
- ▷ When you activate the Dynamic Traction Control DTC
- ▷ When you deactivate the Dynamic Stability Control DSC
- ▷ When DSC or ABS is intervening
- ▷ When the system does not recognize any objects for a longer period of time, e.g. on infrequently traveled roads without a shoulder or guard rails, or if the radar sensor is covered with dirt, refer to page 69
- ▷ When you apply the parking brake

⚠ When the system is deactivated, you must brake the vehicle yourself and/or maneuver as necessary, otherwise there is a risk of accident. ◀

Warning lamp



The warning lamp comes on when active cruise control has been automatically deactivated due to a driving speed below 20 mph or 30 km/h, an application of the parking brake or a DSC intervention. A message appears on the Control Display.

Resuming stored desired speed and distance

Briefly press the button, arrow **4**.

The stored speed and distance are regained and maintained.

In the following instances, the stored speed is deleted and can no longer be resumed:

- ▷ When driving stability control systems are intervening
- ▷ In cars with manual transmission: when you shift gears very slowly or shift to idle position
- ▷ In cars with automatic transmission: when you engage selector lever position N
- ▷ When the ignition is switched off

Displays in the instrument cluster



- 1** Stored desired speed
- 2** Shows yellow: vehicle detected ahead
Flashes in red: system cannot maintain distance; driver must brake the vehicle
Flashes in yellow: driving stability control systems are intervening; cruise control is deactivated
- 3** Selected distance to vehicle ahead
The indicator lights up as soon as the system is activated.

4 Selected desired speed is temporarily displayed

If --- mph or --- km/h temporarily appears in the instrument cluster display, it is possible that the system prerequisites for operation are currently not met. Calling up Check Control messages, refer to page 83.

Warning lamps



The indicator 2 flashes in red; a signal sounds. The system indicates that you must brake and/or maneuver the vehicle yourself. Active cruise control cannot automatically restore the distance to the vehicle ahead.

This indicator does not release you from your responsibility to adapt your desired speed and driving style to prevailing driving conditions.



The indicator 2 flashes in yellow. The prerequisites for operating active cruise control are not met, e.g. as a result of ABS or DSC interventions. Active cruise control is deactivated. You can reactivate the system, if desired, by tapping or pulling the lever when

road and traffic conditions permit. It is not possible to resume a stored speed.

Radar sensor

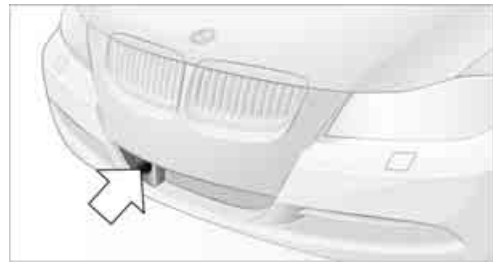

The sensor's ability to detect vehicles ahead may be restricted as a result of heavy rain, dirt, snow or ice. If necessary, clean the radar sensor located in the front bumper, see arrow. Be sure to use particular care when removing any layers of snow or ice from the sensor.

When the radar sensor is not properly positioned, active cruise control cannot be activated at all.

Malfunction



The warning lamp comes on when the system has failed. A message appears on the Control Display. You can find more information starting on page 82.

System limitations

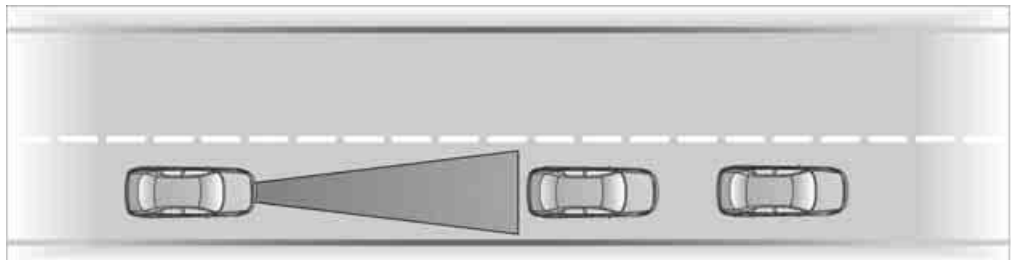

Always remember that the range and ability of the system does have physical limitations. It will not apply the brakes or decelerate your vehicle when there is a slow-moving vehicle, stopped vehicle or stationary object ahead of you, as for example, at a traffic light or a parked vehicle. Also, the system does not react

to oncoming traffic, pedestrians or other types of potential traffic such as a rider on horseback. It is also possible that the system may not detect smaller moving objects such as motorcycles or bicycles. Be especially alert when encountering any of these situations as the system will neither automatically brake, nor provide

a warning to you. Also, be aware that every decrease in the distance setting allows your vehicle to come closer to a vehicle in front of you and requires a heightened amount of alertness. ◀



Active cruise control is not and must not be used as a collision avoidance/warning system. ◀

If while your vehicle is actively following a vehicle in front of you and the vehicle ahead speeds up or the lane ahead becomes clear, then your vehicle will accelerate to the speed you have selected. Be aware that changing to a clear, unobstructed lane will also result in your vehicle accelerating.



Be certain to deactivate the system when you pull into an exit lane for a highway off-ramp. ◀

Also, vehicles traveling in a staggered manner on a highway may cause a delay in the system's reaction to a vehicle in front of you or may cause the system to react to a vehicle actually in the lane next to you. Always be ready to take action or apply the brakes if necessary.



While active cruise control is capable of braking your vehicle automatically when you approach a slower vehicle ahead, it is important to be aware that the ability of the system to apply the brakes is also limited, e.g. when you reduce your desired speed sharply. The system cannot stop your vehicle. It uses only a portion of braking system capacity and does not utilize the full capacity of the vehicle braking system. Therefore, the system cannot decrease your speed for large differences in speed between your vehicle and the vehicle ahead. Examples: when you approach a vehicle traveling at a much lower speed than your own speed such as approaching a toll booth or when a much slower vehicle cuts in front of you at close range. ◀

Active cruise control can only decelerate the vehicle to approx. 20 mph or 30 km/h.

Swerving vehicles

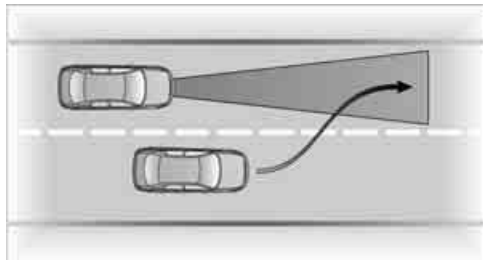

When a vehicle moves from an adjacent lane into your lane, active cruise control will not recognize this vehicle until it is fully in your lane ahead of your vehicle.



When a vehicle ahead suddenly swerves into your lane, the system may not be able to maintain the selected distance automatically. This also applies to great differences in speed between you and vehicles ahead, e.g. when quickly approaching a truck. There is a risk of collision. Once the system has established that a vehicle is indeed in front of you, it will indicate that you must brake and/or maneuver the vehicle yourself. Take action yourself, otherwise there is a risk of an accident. ◀

Behavior in curves



Because of the limited range of the system, it is possible that in curves or on the peaks and valleys of hilly roads, a vehicle ahead may be recognized late, or not at all. Therefore, it is up to the driver to select a speed that is prudent in view of the curves and terrain of the roadway.



In approaching a curve, it is possible that active cruise control would react briefly to a vehicle in the adjacent lane. In addition, the system can sense if your vehicle is in a curve and may not accelerate. If your vehicle decelerates in either case, you can choose to overcome the deceleration by briefly pressing the accelerator pedal.

Your responsibility

Your actions have priority at all times. When you press the accelerator pedal while driving with active cruise control, the automatic braking function will be temporarily interrupted. Once you release the accelerator pedal, the desired speed or the selected distance to the vehicle ahead is achieved again.

 Do not leave your foot on the accelerator pedal and make sure that no objects such as floor mats are lying on the accelerator pedal. Otherwise the system may not be able to brake the vehicle. ◀

Everything under control

Odometer, outside temperature display, clock



- 1 Knob in the instrument cluster
- 2 Outside temperature display and clock
- 3 Odometer and trip odometer

Knob in the instrument cluster

- ▷ To reset the trip odometer while the ignition is switched on
- ▷ To display the time, outside temperature and odometer briefly while the ignition is switched off

Units of measure

To select the respective units of measure, miles or km for the odometer as well as °F or °C for the outside temperature, refer to page 77.

The setting is stored for the remote control currently in use.

Time, outside temperature display

Setting the time, refer to page 80.

Outside temperature warning

When the displayed temperature sinks to approx. +37 °F / +3 °C, a signal sounds and a warning lamp lights up. There is an increased risk of black ice.

 Black ice can also form at temperatures above +37 °F / +3 °C. You should therefore drive carefully on bridges and shaded

roads, for example, otherwise there is an increased risk of an accident. ◀

Odometer and trip odometer

Resetting trip odometer:

With the ignition switched on, press button 1 in the instrument cluster.

When the vehicle is parked

If you still want to view the time, outside temperature and odometer reading briefly after the remote control has been taken out of the ignition lock:

Press button 1 in the instrument cluster.

Tachometer



Never force the engine speed up into the red warning field, see arrow. In this range, the fuel supply is interrupted to protect the engine.

Coolant temperature

A warning lamp will come on if the coolant, and therefore the engine, becomes too hot. In addition, a message will appear on the Control Display.

Check coolant level, refer to page 218.

Energy Control*



Displays the current fuel consumption. This allows you to see whether your current driving style is conducive to fuel economy with minimum exhaust emissions.

Engine oil temperature*



During standard operation, the engine oil temperature is between approx. 120 °F and approx. 300 °F / approx. 50 °C and approx. 150 °C. If the engine oil temperature is too high, a message will appear on the Control Display.

Fuel gauge



Fuel tank capacity: approx. 15.9 US gallons/ 60 liters.

You can find information on refueling on page 201.

If the tilt of the vehicle varies for a longer period, when you are driving in mountainous areas, for example, the indicator may fluctuate slightly.

Reserve

Once the fuel level has fallen to the reserve zone, a message briefly appears on the Control Display and the cruising range for the remaining amount of fuel is displayed on the computer. Under a cruising range of approx. 30 miles/ 50 km, the message remains in the Control Display.

! Refuel as soon as possible once your cruising range falls below 30 miles/ 50 km, otherwise engine functions are not ensured and damage can occur. ◀

Computer

Displays in the instrument cluster



Calling up information

Press the button in the turn indicator lever.

The following items of information are displayed in the order listed:

- ▷ Cruising range
- ▷ Average speed
- ▷ Average fuel consumption
- ▷ Current fuel consumption*

To set the corresponding units of measure, refer to Units of measure on page 77.

Cruising range

Displays the estimated cruising range available with the remaining fuel. The range is calculated on the basis of the way the car has been driven over the last 18 miles/30 km and the amount of fuel currently in the tank.

 Refuel as soon as possible once your cruising range falls below 30 miles/ 50 km, otherwise engine functions are not ensured and damage can occur. ◀

Average speed

Periods with the vehicle parked and the engine switched off are not included in the calculations of average speed.

With the trip computer, refer to page 75, you can have the average speed for another trip displayed.

To reset average speed: press the button in the turn indicator lever for approx. 2 seconds.

Average fuel consumption

The average fuel consumption is calculated for the time during which the engine is running.

With the trip computer, refer to page 75, you can have the average consumption for another trip displayed.

To reset average fuel consumption: press the button in the turn indicator lever for approx. 2 seconds.

Current fuel consumption*

Displays the current fuel consumption. This allows you to see whether your current driving style is conducive to fuel economy with minimum exhaust emissions.

Displays on the Control Display

You can also call up the computer via iDrive; for operating principle refer to page 16.

1. Press the **MENU** button.
This opens the start menu.
2. Move the controller to the right to call up "Navigation".
3. If necessary, move the highlight marker to the uppermost field. Turn the controller until "Car Data" is selected and press the controller.

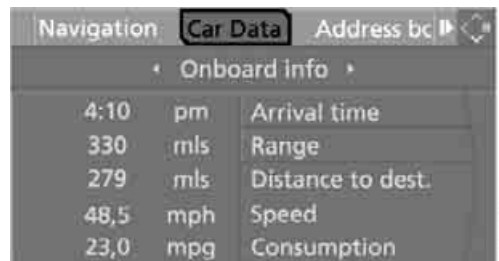

4. Select "Onboard info" and press the controller.



- ▷ Estimated time of arrival at destination:
 - ▷ Manually enter a distance in the computer, refer to information further below
 - ▷ Enter a destination in the navigation system, refer to page 131
- ▷ Cruising range
- ▷ Distance to destination:
 - ▷ Manually enter a distance in the computer, refer to information further below
 - ▷ Enter a destination in the navigation system, refer to page 131
- ▷ Average speed
- ▷ Average fuel consumption

Resetting values

You can reset the values for average speed and average consumption:

1. Select the respective menu item and press the controller.
2. Press the controller again to confirm your selection.

Entering a distance manually

1. Select "Distance to dest." and press the controller.

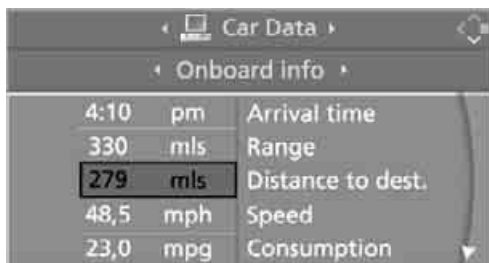

2. Turn the controller to select the distance to your destination.
 3. Press the controller to apply the setting.
- The distance is automatically entered during destination guidance.

Trip computer

The trip computer is suitable e.g. for a holiday trip.

1. Open the start menu.
2. Call up "Navigation".
3. Select "Car Data" and press the controller.
4. Select "Trip computer" and press the controller.



- ▷ Departure time
- ▷ Driving time
- ▷ Distance traveled
- ▷ Average speed
- ▷ Average fuel consumption

Switching trip computer on/off and resetting all values to zero:

1. Select "Set" and press the controller.
2. Select the desired menu item and press the controller.

Display options

You can display the computer or the trip computer in the assistance window.

1. Move the controller to the right to change to the assistance window and press the controller.



2. Select a menu item:
 - ▷ "Onboard info"
 - ▷ "Trip computer"
3. Press the controller.



Settings and information

Operating principle

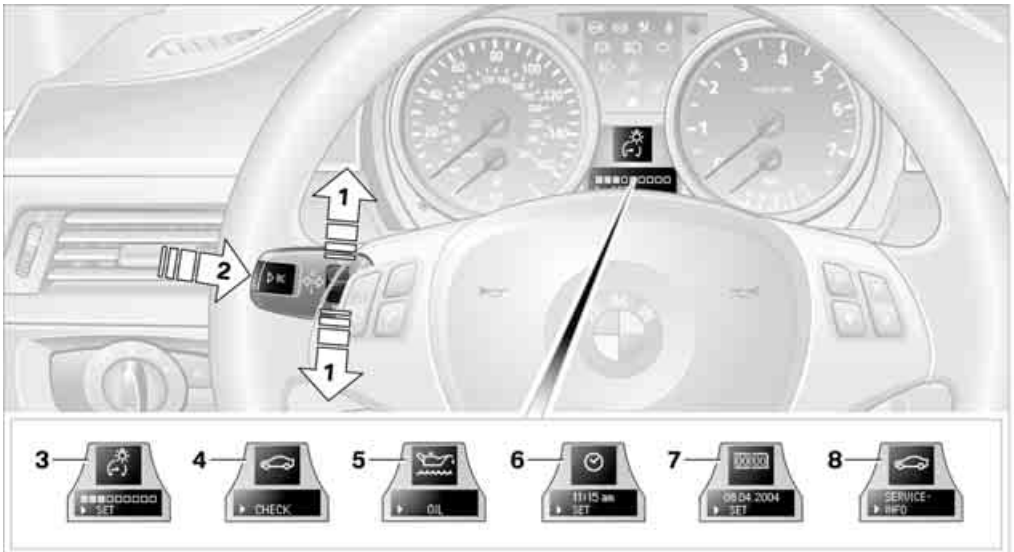

- 1 Button for:
 - ▷ Selecting display
 - ▷ Setting values

- 2 Button for:
 - ▷ Confirming selected display or set values
 - ▷ Calling up computer information 74
- 3 When the lights are on: instrument lighting brightness 100

Exiting displays

The outside-temperature reading and the time reappear when you press button **2** or if you make no entries within approx. 15 seconds. If required, complete the current setting first.

Units of measure

You can set units of measure. The settings are stored for the remote control currently in use, refer also to Personal Profile on page 28.

iDrive, for operating principle refer to page 16.

1. Open the start menu.
2. Press the controller to open the **i** menu.
3. Select "Settings" and press the controller.
4. Select "Language / Units" and press the controller.
5. If necessary, move the highlight marker to the uppermost field. Turn the controller until "Units" is selected and press the controller.

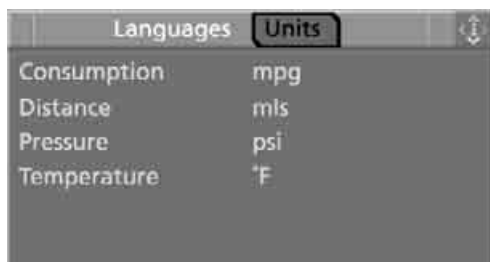

6. Select the desired menu item and press the controller.
7. Select the desired measurement unit and press the controller.

- 4 Calling up Check Control 82
- 5 Checking oil level 215
- 6 Setting the time 80
- 7 Setting the date 81
- 8 Viewing service requirement display 77

Service requirements



The remaining driving distance and the date of the next scheduled service are displayed briefly immediately after you start the engine or switch on the ignition.

▶ The extent of service work required can be read out from the remote control by your BMW Service Advisor. ◀

For certain maintenance operations, you can view the respective distance remaining or due date individually in the instrument cluster.

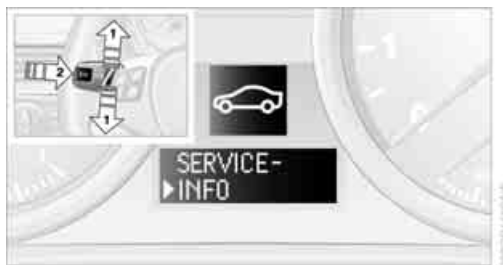

1. Push button **1** in the turn indicator lever up or down repeatedly until the appropriate symbol appears in the display, accompanied by the words "SERVICE-INFO".
2. Press button **2**.
3. Use button **1** to scroll through the individual service items.

Possible displays

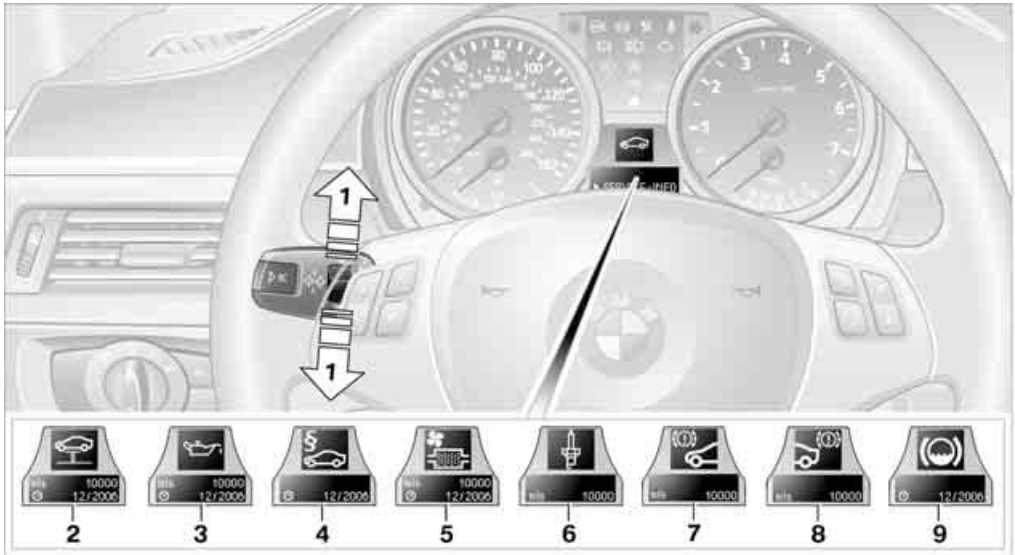

- 1 Button for selecting functions
- 2 Service requirements
- 3 Engine oil
- 4 Roadworthiness test*
- 5 Microfilter
- 6 Spark plugs

- 7 Front brake pads
- 8 Rear brake pads
- 9 Brake fluid

The sequence of displayed service items may vary. The data for the next service appointment is shown first.

Supplementary information

You can have further information on the scope of maintenance displayed on the Control Display, refer to page 16.

- 1. Open the start menu.
- 2. Press the controller to open the **i** menu.
- 3. Select "Info sources" and press the controller.
- 4. Select "Service" and press the controller.
- 5. If necessary, move the highlight marker to the uppermost field. Turn the controller

until "Service requirements" is selected and press the controller.

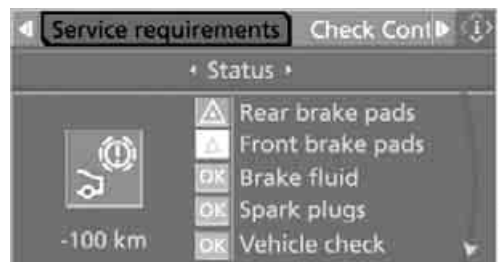

- 6. If necessary, move the highlight marker to the second field from the top. Turn the con-

troller until "Status" is selected and press the controller.

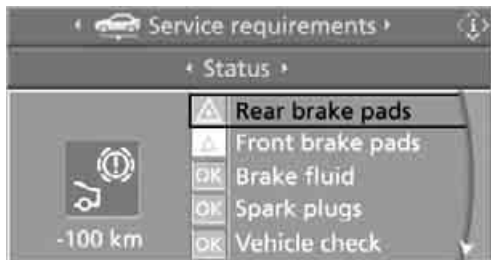

A list of selected maintenance operations and, if applicable, inspections required by law is displayed.

You can request more detailed information on every entry.

Select the entry and press the controller.

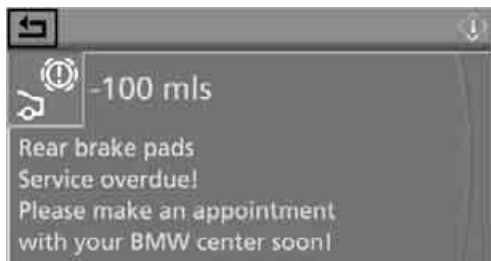

To exit from the menu:

Select the arrow and press the controller.

Symbols



No service is currently required.



The deadline for service or a legally mandated inspection is approaching. Please schedule a service appointment.



The service deadline has already passed.

Entering deadlines for legally required inspections*

Make sure the date on the Control Display is always set correctly, refer to page 81, otherwise the effectiveness of CBS Condition Based Service is not ensured.

1. Open the start menu.
2. Press the controller to open the menu.
3. Select "Info sources" and press the controller.
4. Select "Service" and press the controller.
5. If necessary, move the highlight marker to the uppermost field. Turn the controller until "Service requirements" is selected and press the controller.
6. Select "Status" and press the controller.
7. Select "State inspection" and press the controller.

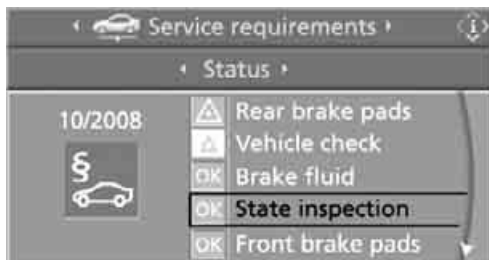

8. Select "Set service date" and press the controller. The month is highlighted.
9. Turn the controller to make the adjustment.



10. Press the controller to apply the setting. The year is highlighted.
11. Turn the controller to make the adjustment.
12. Press the controller to apply the setting. The date entry is stored.

To exit from the menu:

Select and press the controller.

More information on the BMW Maintenance System can be found on page 219.

Clock

The settings are stored for the remote control currently in use, refer also to Personal Profile on page 28.

Setting the time

In the instrument cluster

To set the 12h/24h mode, refer to Setting the time format below.



1. Push button **1** in the turn indicator lever up or down repeatedly until the appropriate symbol appears in the display, accompanied by the time and the word "SET".
2. Press button **2**.
3. Use button **1** to set the hours.
4. Press button **2** to confirm the entry.
5. Use button **1** to set the minutes.
6. Press button **2** to confirm the entry.
7. Press button **2**.
The system accepts the new time.

Via iDrive

iDrive, for operating principle refer to page 16.

1. Press the **MENU** button once or twice until the start menu appears.



2. Press the controller to open the **i** menu.
3. Turn the controller until "Settings" is selected and press the controller.



4. Turn the controller until "Time / Date" is selected and press the controller.



- If necessary, move the controller forwards to move the highlight marker to the upper-most field.

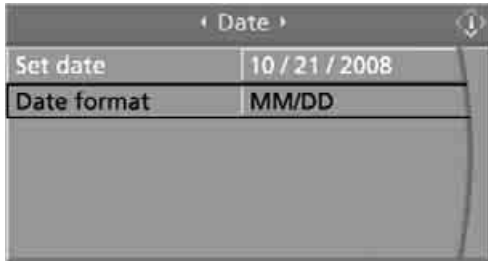

- Turn the controller until "Time" is selected and press the controller.

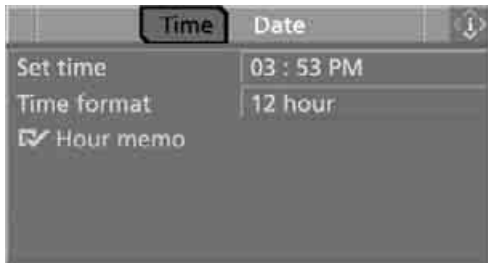

- Turn the controller until "Set time" is selected and press the controller.

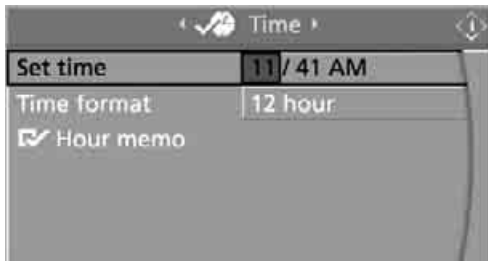

Adjusting settings

- Turn the controller to set the hours and press the controller.
- Turn the controller to set the minutes and press the controller.

The system accepts the new time.

Switching on the hour signal*

You will hear three tones just before each full hour.

Select "Hour memo" and press the controller.

The hour signal is activated.

Setting the time format

- Open the start menu.
- Press the controller to open the **i** menu.
- Turn the controller until "Settings" is selected and press the controller.
- Turn the controller until "Time / Date" is selected and press the controller.
- Select "Time format" and press the controller.
- Select the desired format and press the controller.

Date

The settings are stored for the remote control currently in use, refer also to Personal Profile on page 28.

Setting the date

In the instrument cluster

To set the dd/mm or mm/dd date format, refer to Setting the date format below.



- Push button **1** in the turn indicator lever up or down repeatedly until the appropriate symbol appears in the display, accompanied by the date and the word "SET".
- Press button **2**.
- Use button **1** to set the day of the month.
- Press button **2** to confirm the entry.
- Set the month and the year in the same way.

- Press button **2**.
The system stores the new date.

Via iDrive

iDrive, for operating principle refer to page 16.

- Open the start menu.
- Press the controller to open the **i** menu.
- Turn the controller until "Settings" is selected and press the controller.
- Select "Date" and press the controller.



- Select "Set date" and press the controller. The first date display setting is selected.
- Turn the controller to make the adjustment.
- Press the controller to apply the setting. The next setting is highlighted.
- Make the remaining adjustments. After the last adjustment, the date is stored.

Setting the date format

- Open the start menu.
- Press the controller to open the **i** menu.
- Turn the controller until "Settings" is selected and press the controller.
- Turn the controller until "Time / Date" is selected and press the controller.
- Select "Date format" and press the controller.
- Select the desired format and press the controller.

Check Control

The concept

The Check Control monitors vehicle functions and alerts you to any malfunctions in the systems monitored. Such a Check Control message includes indicator and warning lamps in the instrument cluster and, in some circumstances, an acoustic signal as well as text messages at the bottom of the Control Display.

Indicator and warning lamps

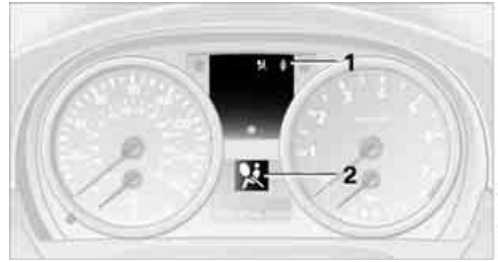

Indicator and warning lamps can light up in both the indicator area **1** and the display **2** in various combinations and colors.



⚠ indicates that Check Control messages have been stored. You can view the Check Control messages whenever it is convenient for you.

Explanatory text messages



Text messages at the lower edge of the Control Display explain the meaning of the displayed indicator and warning lamps.

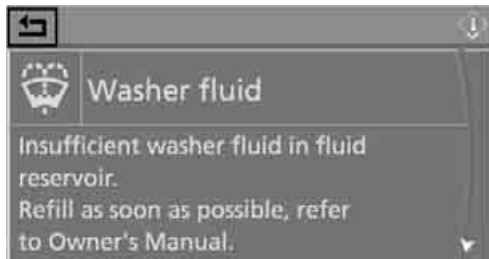

For most Check Control messages, you can view more information later, e.g. regarding the cause of a malfunction and how to respond, refer to page 83.

In urgent cases, this information will be shown as soon as the corresponding lamp comes on.

To exit the displayed information: Select the  arrow and press the controller.

Hiding Check Control messages

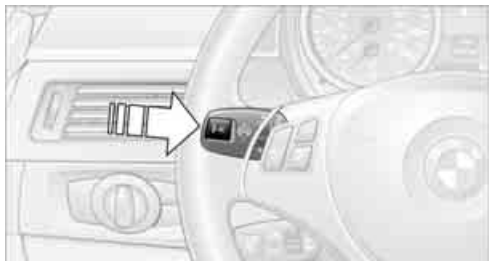

Press the button in the turn indicator lever.

Some Check Control messages remain visible until the malfunctions have been rectified. They cannot be hidden. If several malfunctions occur

at the same time, they are displayed in succession.

 They are marked with the symbol shown here.

Other messages are automatically hidden after approx. 20 seconds, but remain stored.

 They are marked with the symbol shown here.

Viewing stored Check Control messages



1. Push button **1** in the turn indicator lever up or down repeatedly until the appropriate symbol appears in the display, accompanied by the words "CHECK CONTROL".
2. Press button **2**. "CHECK OK" appears if there are no Check Control messages. If a Check Control message has been stored, the corresponding lamp comes on. It is accompanied by a text message on the Control Display.
3. Push button **1** to check for other messages.
4. Press button **2**. The display again shows the outside temperature and the time.

Viewing more information later

iDrive, for operating principle refer to page 16.

1. Press the **MENU** button. This opens the start menu.
2. Press the controller to open the  menu.

3. Select "Info sources" and press the controller.



4. Select "Service" and press the controller.
5. If necessary, move the highlight marker to the uppermost field. Turn the controller until "Check Control messages" is selected and press the controller.

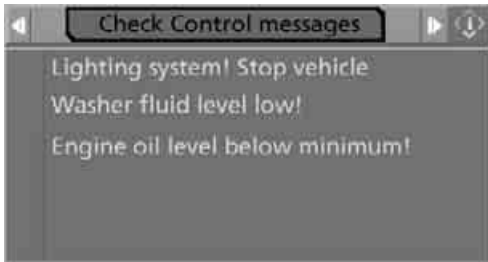

6. Select a text message and press the controller.

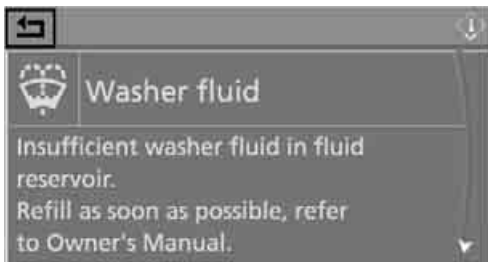

To exit the display:
Select  and press the controller.

Speed limit

You can enter a speed, and a Check Control message will indicate when you reach this speed. This enables you, for example, to receive warnings if you exceed a speed limit in

an urban area.
You are only warned of reaching this speed a second time if your vehicle speed falls below it again by at least 3 mph or 5 km/h.

iDrive, for operating principle refer to page 16.

1. Open the start menu.
2. Call up "Navigation".
3. Select "Car Data" and press the controller.
4. Select "Limit" and press the controller.



Setting or changing the limit

1. Select speed value and press the controller.
2. Turn the controller to set the limit.
3. Press the controller to apply the setting.

Applying your current speed as limit

Select "Select current speed" and press the controller. The system adopts your current speed as the limit.

Activating the limit

Select "On" and press the controller.

Limit is activated.

Stopwatch

iDrive, for operating principle refer to page 16.

1. Open the start menu.
2. Call up "Navigation".
3. Select "Car Data" and press the controller.

4. Select "Stopwatch" and press the controller.



Starting, stopping or resetting

- ▷ Select "Start" and press the controller. The stopwatch starts at the displayed time.
- ▷ Select "Reset" and press the controller. The stopwatch is reset and restarts if it was running beforehand.
- ▷ Select "Stop" and press the controller. This stops the timer.

Taking an interim time reading

Select "Interim time" and press the controller. The interim time appears below the ongoing primary stopwatch count.

 All of the remaining functions remain available at all times while the stopwatch is running. The stopwatch continues operation in the background. ◀

Altering settings

Language on the Control Display

The language of the Control Display can be set. The setting is stored for the remote control currently in use.

iDrive, for operating principle refer to page 16.

1. Open the start menu.
2. Press the controller to open the **i** menu.
3. Turn the controller until "Settings" is selected and press the controller.
4. If necessary, move the highlight marker to the uppermost field. Turn the controller

until "Languages" is selected and press the controller.

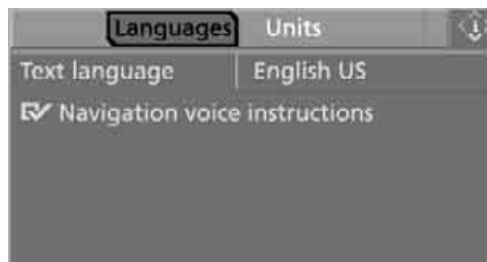

5. Select "Text language" and press the controller. You can switch to another language for the display texts and navigation messages.
6. Select and activate the desired language by pressing the controller.

Brightness of the Control Display

The brightness is automatically adapted to the ambient lighting conditions. Note, however, that you can change the basic setting while the low beams are switched on. The setting is stored for the remote control currently in use.

iDrive, for operating principle refer to page 16.

1. Open the start menu.
2. Press the controller to open the **i** menu.
3. Turn the controller until "Settings" is selected and press the controller.
4. If necessary, move the highlight marker to the uppermost field. Turn the controller until "Brightness" is selected and press the controller.



5. Turn the controller until the desired setting is reached.

Technology for driving comfort and safety

PDC Park Distance Control*

The concept

The PDC assists you with maneuvering in tight parking spaces. Acoustic signals and a visual indicator warn you of the presence of an object behind your vehicle. To measure the distance, there are four ultrasonic sensors in either bumper.

These sensors have a range of approx. 6.5 ft/ 2 m. However, an acoustic warning does not sound until an object is approx. 24 in/60 cm from the corner sensors, or approx. 5 ft/1.50 m from the center sensors.

 PDC is a parking aid that can indicate objects when they are approached slowly, as is usually the case when parking. Avoid approaching an object at high speed, otherwise physical circumstances may lead to the system warning being issued too late. ◀

Switching on automatically

With the engine running or the ignition switched on, the system is activated automatically after approx. 1 second when you engage reverse gear or move the automatic transmission selector lever to position R. Wait this short period before driving.

Signal tones

When nearing an object, its position is indicated correspondingly by an interval tone. As the distance between vehicle and object decreases, the intervals between the tones become shorter. If the distance to the nearest object falls to below roughly 1 ft/30 cm, then a continuous tone sounds.

An interval tone is interrupted after approx. 3 seconds

- ▷ if you remain in front of an object that has been detected by only one of the corner sensors
- ▷ if you are driving parallel to a wall.

Malfunction



The indicator lamp in the instrument cluster comes on. PDC is malfunctioning. A message appears on the Control Display. Have the system checked.

To avoid this problem, keep the sensors clean and free of ice or snow in order to ensure that they will continue to operate effectively. When using a high-pressure cleaner, do not spray the sensors for extended periods of time and only from a distance of at least 4 in/10 cm.

PDC with visual warning

You can also have the system show distances to objects on the Control Display. The contours of distant objects are shown on the Control Display even before the acoustic signal sounds. The setting is stored for the remote control currently in use.

iDrive, for operating principle refer to page 16.

1. Open the start menu.
2. Press the controller to open the  menu.
3. Select "Settings" and press the controller.



4. Select "Vehicle / Tires" and press the controller.
5. If necessary, move the highlight marker to the uppermost field. Turn the controller

until "PDC" is selected and press the controller.

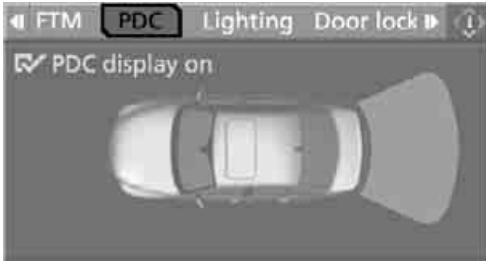

6. Select "PDC display on" and press the controller.

The PDC screen is activated.

The display is shown on the Control Display as soon as PDC is activated.

System limitations

 Even with PDC, final responsibility for estimating the distance between the vehicle and any obstructions always remains with the driver. Even when sensors are provided, there is a blind spot in which objects can no longer be detected. The system is also subject to the physical limits that apply to all forms of ultrasonic measurement, such as those encountered with trailer towbars and couplings, thin and wedge-shaped objects, etc. Low objects already indicated, such as a curb, may enter the sensors' dead areas before a continuous audible signal is given. Higher, protruding objects, such as wall ledges, may not be detectable. Loud sound sources outside or inside the car can drown out the PDC signal. ◀

Driving stability control systems

Your BMW has a number of systems that help to maintain the vehicle's stability even in adverse driving conditions.

ABS Antilock Brake System

ABS prevents locking of the wheels during braking. Safe steering response is maintained

even during full braking. Active safety is thus increased.

The ABS is operational every time you start the engine. Braking safely, refer to page 123.

Electronic brake-force distribution

The system controls the brake pressure in the rear wheels to ensure stable braking behavior.

DBC Dynamic Brake Control

When you apply the brakes rapidly, this system automatically produces the maximum braking force boost and thus helps to achieve the shortest possible braking distance during full braking. This system exploits all of the benefits provided by ABS.

Do not reduce the pressure on the brake for the duration of the full braking application.

DSC Dynamic Stability Control

DSC prevents the driving wheels from losing traction when you pull away from rest or accelerate. DSC also recognizes unstable driving conditions, for example if the rear of the car is about to swerve or if momentum is acting at an angle past the front wheels. In these cases, DSC helps the vehicle maintain a safe course within physical limits by reducing engine output and through braking actions at the individual wheels.

 The laws of physics cannot be repealed, even with DSC. An appropriate driving style always remains the responsibility of the driver. Therefore, do not reduce the additional safety margin again by taking risks. ◀

Deactivating DSC



Press the button for at least 3 seconds; the indicator lamps for DSC in the instrument cluster light up. Dynamic Traction Control DTC and DSC have been simultaneously deactivated. Stabilizing and drive-output promoting actions are no longer executed.

To increase vehicle stability, activate DSC again as soon as possible.

Activating DSC

Press the button again; the indicator lamps in the instrument cluster go out.

For better control



If the indicator lamp flashes:
DSC controls the drive forces and brake forces.



If the indicator lamps are on:
DSC is deactivated.

DTC Dynamic Traction Control

DTC is a version of DSC in which the drive output is optimized for particular road conditions, e.g. unplowed snow-covered roads. The system assures the maximal drive output, but with reduced driving stability. It is therefore necessary to drive with appropriate caution.

You may find it useful to briefly activate DTC under the following special circumstances:

- ▷ When driving uphill on snow-covered roads, in slush or on unplowed, snow-covered roads
- ▷ When rocking a stuck vehicle free or starting off in deep snow or on loose ground

- ▷ When driving with snow chains

Activating DTC



Press the button; the indicator lamps for DTC in the instrument cluster come on.

For better control



If the indicator lamp flashes:
DTC controls the drive forces and brake forces.



If the indicator lamps are on:
DTC has been activated.

Deactivating DTC

Press the button again; the DTC indicator lamps in the instrument cluster go out.

xDrive

xDrive is your BMW's four-wheel-drive system. The combined efforts of xDrive and DSC help to further optimize traction and driving dynamics. The xDrive four-wheel-drive system distributes driving power variably to the front and rear axles depending on the driving situation and road conditions.

Hill Descent Control

HDC is a downhill driving assistant that reduces your speed on steep downhill gradients and makes it even easier to control your BMW's handling under these conditions. The vehicle then moves slightly faster than double walking speed without the driver needing to intervene.

HDC can be activated as long as you are driving under approx. 20 mph or 35 km/h. When driving downhill at a speed of under approx. 20 mph or

35 km/h, the vehicle's speed is automatically reduced to slightly more than double walking speed and maintained.

Increasing or decreasing speed

By accelerating or braking you can change the speed within a range from approx. 3 to 15 mph, approx. 5 to 25 km/h.

You can specify a target speed within the same range using the cruise control lever.

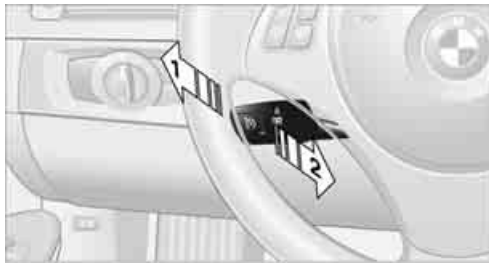

- 1 To increase speed
- 2 To decrease speed

Activating HDC



Press the button; the indicator lamp lights up. The indicator lamp flashes when the vehicle is being braked automatically.

Deactivating HDC

Press the button again; the indicator lamp goes out.

HDC is automatically deactivated in the following situations:

- ▷ at speeds above approx. 40 mph or 60 km/h
- ▷ after switching off the ignition.

Using HDC

In cars with manual transmission:

Use HDC in lower gears and in reverse gear.

With automatic transmission:

You can use HDC in any drive position.

Displays in the instrument cluster



- 1 Display for target speed
- 2 HDC display

Malfunction

The HDC display disappears during HDC operation, or does not appear:

HDC is temporarily unavailable due to excessive brake temperature, or DSC has failed.

Drive-off assistant

The drive-off assistant enables you to drive off smoothly on uphill gradients. It is not necessary to use the parking brake for this.

1. Hold the car in place by depressing the brake.
2. Release the brake and drive off without delay.

 The drive-off assistant holds the car in place for approx. 2 seconds after the brake is released. Depending on vehicle load, the car may roll backwards a little during this time span. Drive off without delay after releasing the brake. Otherwise, the drive-off assistant will no longer hold the car in place after approx. 2 seconds and the car will start to roll backwards. ◀

Flat Tire Monitor FTM*

The concept

The Flat Tire Monitor monitors tire pressures while the car is being driven. The system reports any significant loss of pressure in one tire in relation to another.

If a tire loses pressure, its rolling radius changes, and this in turn alters the speed of rotation. This change is detected and is reported as a flat tire.

Functional requirement

In order to assure the reliable reporting of a flat tire, the system must be initialized for the correct tire inflation pressure.

- ▶ The system must be reinitialized each time a tire inflation pressure has been corrected or a wheel or tire has been changed. ◀

System limitations

⚠ The Flat Tire Monitor is unable to warn the driver of sudden, severe tire damage caused by external factors, nor can it identify the gradual loss of pressure that will inevitably occur in all four tires over a lengthy period of time. ◀

In the following situations, the system could be delayed or malfunction:

- ▶ System has not been initialized
- ▶ Driving on snowy or slippery road surface
- ▶ Performance-oriented style of driving: slip in the drive wheels, high lateral acceleration
- ▶ Snow chains are attached

Initializing the system

▶ The initialization is completed during driving, which can be interrupted at any time. When driving resumes, the initialization is continued automatically. Do not initialize the system while snow chains are attached. ◀

iDrive, for operating principle refer to page 16.

1. Press the **MENU** button. This opens the start menu.
2. Press the controller to open the **i** menu.
3. Select "Settings" and press the controller.



4. Select "Vehicle / Tires" and press the controller.
5. If necessary, move the highlight marker to the uppermost field. Turn the controller until "FTM" is selected and press the controller.

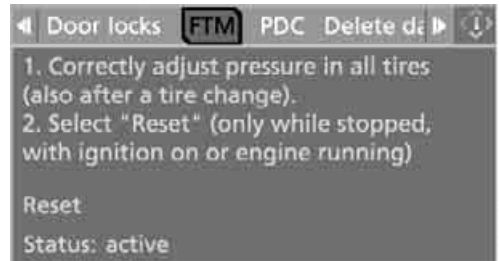

6. Start the engine, but do not start driving.
7. Select "Reset" and press the controller.
8. Select "Yes" and press the controller.



9. Start to drive. Initialization is completed while the car is in motion.

Indication of a flat tire



The warning lamps come on in yellow and red. A message appears on the Control Display. In addition, an acoustic signal sounds. There is a flat tire or substantial loss of tire pressure.

1. Cautiously reduce speed to below 50 mph or 80 km/h. Avoid sudden braking and steering maneuvers. Do not exceed a speed of 50 mph or 80 km/h.



If the car is not equipped with Run-Flat Tires, refer to page 212, the standard equipment by design, do not continue driving. Otherwise a severe accident could result after a tire puncture if you continue driving. ◀

2. At the next opportunity, check the air pressure in all four tires.



If all four tires are inflated to the correct pressures, the Flat Tire Monitor might not have been initialized. The system must then be initialized. ◀

3. In the event of complete tire pressure loss, 0 psi/0 kPa, you can estimate the possible distance for continued driving on the basis of the following guidelines:

- ▶ With a light load:
1 to 2 persons without luggage:
approx. 155 miles/250 km
- ▶ With a medium load:
2 persons, cargo bay full, or 4 persons without luggage:
approx. 90 miles/150 km
- ▶ With a full load or when towing a trailer:
4 or more persons, cargo bay full:
approx. 30 miles/50 km



Drive cautiously and do not exceed a speed of 50 mph or 80 km/h. In the event of pressure loss, vehicle handling changes. This includes reduced tracking stability in braking, extended braking distance and altered natural steering characteristics.

If unusual vibration or loud noises occur during the journey, this may be an indication that the damaged tire has finally failed. Reduce your speed and pull over as soon as possible at a

suitable location. Otherwise parts of the tire could come loose, resulting in an accident. Do not continue driving. Instead, contact your BMW center. ◀

Malfunction



The warning lamps come on in yellow. A message appears on the Control Display. The Flat Tire Monitor has a malfunction or has failed. Have the system checked as soon as possible.

Tire Pressure Monitor TPM*

The concept

TPM checks the inflation pressures of the four mounted tires. The system notifies you if there is a significant loss of pressure in one or more tires.

Functional requirement

In order to assure the reliable reporting of a flat tire, the system must be reset while all tire inflation pressures are correct.

Always use wheels with TPM electronics. Otherwise, the system may malfunction.



Each time a tire inflation pressure has been corrected or a wheel or tire has been changed, reset the system. ◀

System limitations



TPM cannot warn you in advance of sudden severe tire damage caused by outside influences. ◀

The system does not work correctly if it has not been reset; for example, a flat tire may be indicated even though the tire inflation pressures are correct.

The system is inactive and cannot indicate a flat tire if a wheel without TPM electronics, such as a compact spare wheel, has been mounted, or if TPM is temporarily malfunctioning due to other systems or devices using the same radio frequency.

Status indicator on the Control Display

The color of the tires represents the status of the tires and the system.

TPM takes into account that tire pressures change while the vehicle is being driven. The tire pressures do not need to be corrected unless the TPM instructs you to do so by means of color indicators.

Green

The tire inflation pressure corresponds to the established target value.

"TPM active" appears on the Control Display.

One wheel yellow

There is a flat tire or substantial loss of tire pressure in the indicated tire. A message appears on the Control Display.

All wheels yellow

There is a flat tire or substantial loss of tire pressure in several tires. A message appears on the Control Display.

Gray

The system cannot detect a puncture.

Possible reasons for this:

- ▷ TPM is being reset
- ▷ Temporary malfunction caused by systems or devices using the same radio frequency
- ▷ Malfunction

Resetting the system

 Each time a tire inflation pressure has been corrected or a wheel or tire has been changed, reset the system. ◀

iDrive, for operating principle refer to page 16.

1. Press the **MENU** button
The start menu is called up.
2. Press the controller to open the **i** menu.

3. Select "Settings" and press the controller.



4. Select "Vehicle / Tires" and press the controller.
5. If necessary, move the highlight marker to the uppermost field. Turn the controller until "TPM" is selected and press the controller.

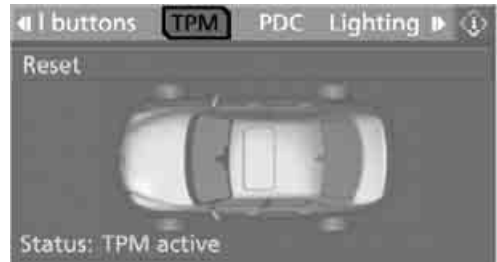

6. Start the engine, but do not start driving.
7. Select "Reset" and press the controller.
8. Select "Yes" and press the controller.

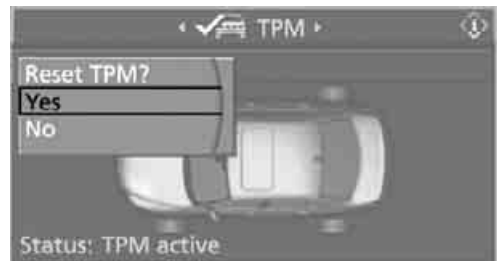

9. Start to drive.
The tires are shown in gray and "Resetting TPM..." is displayed.

After driving a few minutes, the set inflation pressures in the tires are accepted as the target values to be monitored. The system reset is completed during your drive, and can be inter-

rupted at any time. When driving resumes, the reset is continued automatically. On the Control Display, the tires are shown in green and "Status: TPM active" is shown again.



If a flat tire is detected while the system is resetting and determining the inflation pressures, all tires on the Control Display are displayed in yellow. The message "Tire low!" is shown. ◀

Message for low tire inflation pressure



The warning lamps come on in yellow and red. A message appears on the Control Display. In addition, a signal sounds. There is a flat tire or substantial loss of tire pressure.

1. Cautiously reduce speed to below 50 mph/80 km/h. Avoid sudden braking and steering maneuvers. Do not exceed a speed of 50 mph/80 km/h.



If the car is not equipped with Run-Flat Tires, refer to page 212, the standard equipment by design, do not continue driving. Otherwise a severe accident could result after a tire puncture if you continue driving. ◀

2. In the event of complete pressure loss, 0 psi/0 kPa, you can estimate the possible distance for continued driving on the basis of the following guidelines:

- ▷ With a light load:
1 to 2 persons without luggage:
approx. 155 miles/250 km
- ▷ With a medium load:
2 persons, cargo bay full, or 4 persons without luggage:
approx. 95 miles/150 km
- ▷ With a full load:
4 or more persons, cargo bay full:
approx. 30 miles/50 km



Drive cautiously and do not exceed a speed of 50 mph/80 km/h. In the event of pressure loss, vehicle handling changes. This includes reduced tracking stability in braking, extended braking distance and altered natural steering characteristics.

If unusual vibration or loud noises occur during the journey, this may be an indication that the damaged tire has finally failed. Reduce your speed and pull over as soon as possible at a suitable location. Otherwise parts of the tire could come loose, resulting in an accident. Do not continue driving. Instead, contact your BMW center. ◀

Malfunction



The small warning lamp flashes in yellow and then lights up continuously; the larger warning lamp comes on in yellow. On the Control Display, the tires are shown in gray and a message appears. No punctures can be detected.

This type of message is shown in the following situations:

- ▷ If there is a malfunction
Have the system checked.
- ▷ If a wheel without TPM electronics has been mounted
- ▷ If TPM is temporarily malfunctioning due to other systems or devices using the same radio frequency.

Message for unsuccessful system reset



Both warning lamps come on in yellow. A message will appear on the Control Display. The system is not reset after a tire has been changed, for example.

Check the tire inflation pressure and reset the system, refer to page 92.

Declaration according to NHTSA/ FMVSS 138 Tire Pressure Monitoring Systems

Each tire should be checked monthly when cold and inflated to the inflation pressure recommended by the vehicle manufacturer on the vehicle placard or tire inflation pressure label. If your vehicle has tires of a different size than the size indicated on the vehicle placard or tire inflation pressure label, you should determine the proper tire inflation pressure for those tires. As

an added safety feature, your vehicle has been equipped with a tire pressure monitoring system, TPMS, that illuminates a low tire pressure telltale when one or more of your tires are significantly under-inflated. Accordingly, when the low tire pressure telltale illuminates, you should stop and check your tires as soon as possible, and inflate them to the proper pressure. Driving on a significantly underinflated tire causes the tire to overheat and can lead to tire failure. Underinflation also reduces fuel efficiency and tire tread life, and may affect the vehicle's handling and stopping ability. Please note that the TPMS is not a substitute for proper tire maintenance, and it is the driver's responsibility to maintain correct tire pressure, even if underinflation has not reached the level at which the TPMS low tire pressure telltale illuminates.

The TPMS malfunction indicator is combined with the low tire pressure telltale. When the system detects a malfunction, the telltale will flash for approximately one minute and then remain continuously lit. This sequence will continue upon subsequent vehicle startups as long as the malfunction exists. When the malfunction indicator is illuminated, the system may not be able to detect or signal low tire pressure as intended. TPMS malfunctions may occur for a variety of reasons, including the installation of replacement or alternate tires or wheels on the vehicle that prevent the TPMS from functioning properly. Always check the TPMS malfunction telltale after replacing one or more tires or wheels on your vehicle to ensure that the replacement or alternate tires and wheels allow the TPMS to continue to function properly.

Active steering*

The concept

Active steering varies the turning angle of the front wheels in relation to steering wheel movements. It also varies the steering force required to turn the wheels depending on the speed at which you are driving.

When you are driving in the low road-speed range, e.g. in a town or when parking, the steer-

ing angle increases, i.e. the steering becomes very direct, and less effort is required to turn the wheels. In the higher speed range, on the other hand, the steering angle is reduced more and more. This improves the handling capability of your BMW over the entire speed range.

In critical situations, the system can make targeted corrections to the steering angle provided by the driver and thus stabilize the vehicle before the driver intervenes. This stabilizing intervention is simultaneously deactivated when DSC is switched off, refer to page 88.

Malfunction



The warning lamps come on. Active steering is no longer operational. At low speeds, greater steering wheel movements are required, whereas at

higher speeds the vehicle reacts more sensitively to steering wheel movements. The stability-enhancing feature may also be deactivated. Drive cautiously and think well ahead. Have the system checked.

If the warning lamp lights up during the first engine starting following a power supply interruption, the system must be activated by being initialized.

Brake Force Display

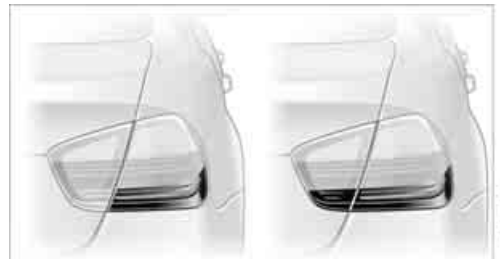

On the left: normal braking

On the right: sharp braking



The following airbags are located under the marked covers:

- 1 Front airbags for driver and front passenger
- 2 Head airbags, front and rear
- 3 Side airbags in the seat backrests

Protective action

 Observe the adjustment instructions on page 44 to ensure the best possible personal protection. ◀

The front airbags help protect the driver and front passenger by responding to frontal impacts in which safety belts alone cannot provide adequate restraint. When needed, the head and side airbags help provide protection in the event of side impact. The relevant side airbag supports the side upper body area. The head air bag supports the head.

The airbags have been designed to not be triggered in every collision situation, e.g. not in minor accidents or rear-end collisions.

 Do not apply adhesive materials to the cover panels of the airbags, cover them or modify them in any other way. Do not attach seat covers, cushions or other objects not specifically approved for seats with integral side airbags to the front seats. Do not hang items of clothing such as coats or jackets over the backrests. Do not attempt to remove the airbag retention system from the vehicle. Do not modify the individual components of the system or its wiring in any way. This includes the upholstered covers on the steering wheel, instrument panel, seats and roof posts, as well as the sides

of the roof lining. Do not attempt to remove or dismantle the steering wheel.

Do not touch the individual components immediately after the system has been triggered, because there is a danger of burns.

In the event of malfunctions, deactivation, or triggering of the airbag restraint system, have the testing, repair, removal, and disposal of airbag generators executed only by a BMW center or a workshop that works according to BMW repair procedures with correspondingly trained personnel and has the required explosives licenses. Unprofessional attempts to service the system could lead to failure in an emergency or undesired airbag activation, either of which could result in personal injury. ◀

Warning notices and information about the airbags can also be found on the sun visors.

Automatic deactivation of the front passenger airbags

An analysis of the impression in the front passenger seat cushion determines whether and how the seat is occupied. The front and side airbags for the front passenger are activated or deactivated by the system accordingly.

 The indicator lamp above the interior rearview mirror shows the current status of the front passenger airbags, deactivated or activated, refer to Status of front passenger airbags below.

 Before transporting a child on the front passenger seat, read the safety precautions and handling instructions under Transporting children safely, refer to page 53.

The front and side airbags can also be deactivated by adolescents and adults sitting in certain positions; the indicator lamp for the front passenger airbags comes on. In such cases, the passenger should change his or her sitting position so that the front passenger airbags are activated and the indicator lamp goes out. If the desired airbag status cannot be achieved by changing the sitting position, transport the relevant passenger on a rear seat. Do not attach seat covers, seat cushion padding, ball mats or other items to the front passenger seat unless they are specifically recommended by BMW. Do not place any items under the seat which could press against the seat from below. Otherwise a correct analysis of the seat cushion is not ensured. ◀

Status of front passenger airbags



The indicator lamp for the front passenger airbags shows the functional status of the front passenger's front and side airbags in accordance with whether and how the front passenger seat is occupied. The indicator lamp shows whether the front passenger airbags are activated or deactivated.

- ▷ The indicator lamp comes on as intended when a child in a specially designated child-restraint system is detected on the seat. The front and side airbags for the front passenger are not activated.
- ▷ The indicator lamp does not come on as long as a person of sufficient size and in a correct sitting position is detected on the seat. The front and side airbags for the front passenger are activated.

- ▷ The indicator lamp does not come on if the seat is empty. The front and side airbags for the front passenger are not activated.

Operational readiness of airbag system



As of radio readiness, refer to page 57, the warning lamp comes on briefly to indicate that the entire airbag system and the belt tensioners are operational.

Airbag system malfunction

- ▷ Warning lamp does not come on with the key in radio-ready position or higher
 - ▷ Warning lamp remains permanently on
-  In the event of a fault in the airbag system, have it checked without delay, otherwise there is the risk that the system will not function as intended even if a sufficiently severe accident occurs. ◀

Lamps

Parking lamps/low beams

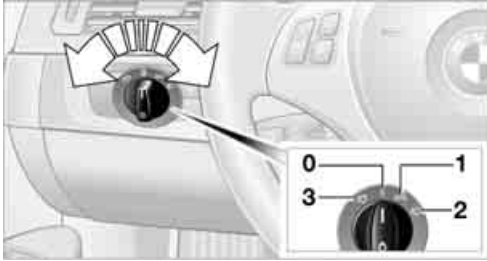

- 0 Lamps off and daytime running lamps
- 1 Parking lamps and daytime running lamps
- 2 Low beams
- 3 Automatic headlamp control*, daytime running lamps and Adaptive Head Light*

Parking lamps

In switch position **1**, the front, rear and side vehicle lighting is switched on. You can use the parking lamps for parking.

 The parking lamps will discharge the battery. Therefore, do not leave them on for unduly long periods of time, otherwise the battery might not have enough power to start the engine. It is preferable to switch on the left-hand or right-hand roadside parking lamps, refer to page [99](#). ◀

Low beams

The low beams light up when the light switch is in position **2** and the ignition is on.

If the light switch remains in position **2**, the exterior lamps are switched off automatically when the driver's door is opened while the ignition is off.

If necessary, switch on the parking lamps as described in the section about parking lamps.

Automatic headlamp control*

When the switch is in position **3**, the low beams are switched on and off automatically depend-

ing on ambient light conditions, e.g. in a tunnel, in twilight, or if there is precipitation. The LED next to the symbol is illuminated when the low beams are on.

When driving into tunnels with bright overhead lights, there may be a delay before the headlamps come on.

The headlamps may also come on when the sun is sitting low on a blue sky.

 The low beams remain switched on independent of the ambient lighting conditions when you switch on the fog lamps*. ◀

If desired, the light switch can remain in position **3**. The exterior lamps are automatically switched off after the vehicle is parked.

 The automatic headlamp control cannot serve as a substitute for your personal judgment in determining when the lamps should be switched on in response to ambient lighting conditions. For example, the system cannot detect fog or hazy weather. To avoid safety risks, you should always switch on the low-beam headlamps manually under these conditions. ◀

Adjusting sensitivity

You can program how sensitively the system reacts to ambient light.

iDrive, for operating principle refer to page [16](#).

1. Press the **MENU** button. This opens the start menu.
2. Press the controller to open the **i** menu.
3. Select "Settings" and press the controller.
4. Select "Vehicle / Tires" and press the controller.

5. Select "Lighting" and press the controller.



6. Select "Auto. headlamps" and press the controller.
7. Select a menu item:
 - ▷ "Sensitive"
 - ▷ "Normal"
 - ▷ "Slower"



8. Press the controller to apply the setting.

Pathway lighting

If you activate the headlamp flasher after parking the car, with the lights switched off, the low beams come on and remain on for a certain time.

You can adjust the operating period or deactivate the function.

1. Open the start menu.
2. Press the controller to open the **i** menu.
3. Select "Settings" and press the controller.
4. Select "Vehicle / Tires" and press the controller.

5. Select "Lighting" and press the controller.



6. Select "Pathway lighting" and press the controller.
7. Turn the controller to select the corresponding duration.
8. Press the controller to apply the setting.

Daytime running lamps

If desired, the light switch can remain in automatic headlamp control position. The exterior lamps are automatically switched off after the vehicle is parked.

If the light switch remains in parking lamps position, the parking lamps are lit after the ignition is switched off.

Activating/deactivating daytime running lamps*

1. Open the start menu.
2. Press the controller to open the **i** menu.
3. Select "Settings" and press the controller.
4. Select "Vehicle / Tires" and press the controller.
5. Select "Lighting" and press the controller.



6. Select "Daytime running lamps" and press the controller.

- ✔ The daytime running lamps are switched on.

Adaptive Head Light*

The concept

Adaptive Head Light is a variable headlamp control system that enables better illumination of the road surface. Depending on the steering angle and other parameters, the light from the headlamp follows the course of the road.

Activating Adaptive Head Light

With the ignition switched on, turn the light switch to the automatic headlamp control position, refer to page 97.

To avoid dazzling the drivers of oncoming vehicles, Adaptive Head Light is not active when the car is driven in reverse, and directs the light to the front passenger's side when the vehicle is at a standstill.

Malfunction

The LED next to the symbol for automatic headlamp control flashes. Adaptive Head Light is malfunctioning or has failed. Have the system checked as soon as possible.

High beams/roadside parking lamps

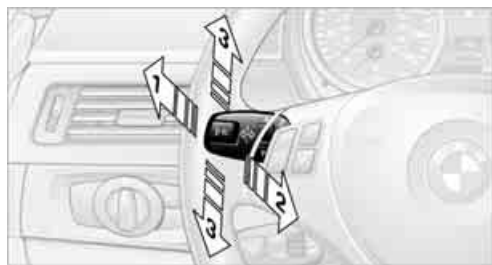

- 1 High beams
- 2 Headlamp flasher
- 3 Roadside parking lamps*

Roadside parking lamps, left or right*

There is an additional option of switching on the lamps on the side of the car facing the road when parked.

Switching on

After parking the vehicle, press the lever up or down beyond the pressure point, arrow 3.

▶ The roadside parking lamps drain the battery. Therefore, do not leave them on for unduly long periods of time, otherwise the battery might not have enough power to start the engine. ◀

Switching off

Briefly press the lever in the opposite direction to the pressure point, arrow 3.

Fog lamps*



☞ The parking lamps or low beams must be switched on for the fog lamps to operate. The green indicator lamp in the instrument cluster lights up whenever the fog lamps are on.

Depending on your vehicle's equipment version, the fog lamps are switched off when you activate the headlamp flasher or switch on the high beams*.

▶ If the automatic headlamp control is activated, the low beams will come on automatically when you switch on the fog lamps. ◀

Instrument lighting

You can adjust the brightness of the instrument lighting only when the parking lamps or the low beams are switched on.



1. Push button 1 up or down repeatedly until the appropriate symbol appears in the display, accompanied by the brightness setting and scale the word "SET".
2. Press button 2.



3. Push button 1 up or down to select the desired brightness level.
4. Press button 2 in the turn indicator lever. The display again shows the outside temperature and the time.

Interior lamps

The interior lamps, including the footwell lamps*, the cargo-bay lamp and the courtesy lamps* are controlled automatically.

The LEDs for the courtesy lamps are set in the door handles and illuminate the ground in front of the doors.

 To avoid draining the battery, all lamps inside the car are switched off about

15 minutes after the ignition is switched off, refer to Start/stop button on page 57. ◀

Switching interior lamps on/off manually



Interior lamps, front and rear*:
To switch on and off, press the button.

To switch off the interior lamps permanently, press the button for the front interior lamp for about 3 seconds.

Reading lamps

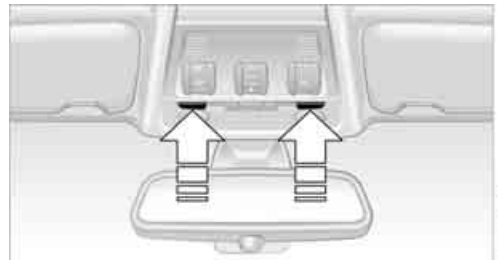

There are reading lamps at the front and rear*, next to the interior lamps. To switch on and off, press the button.

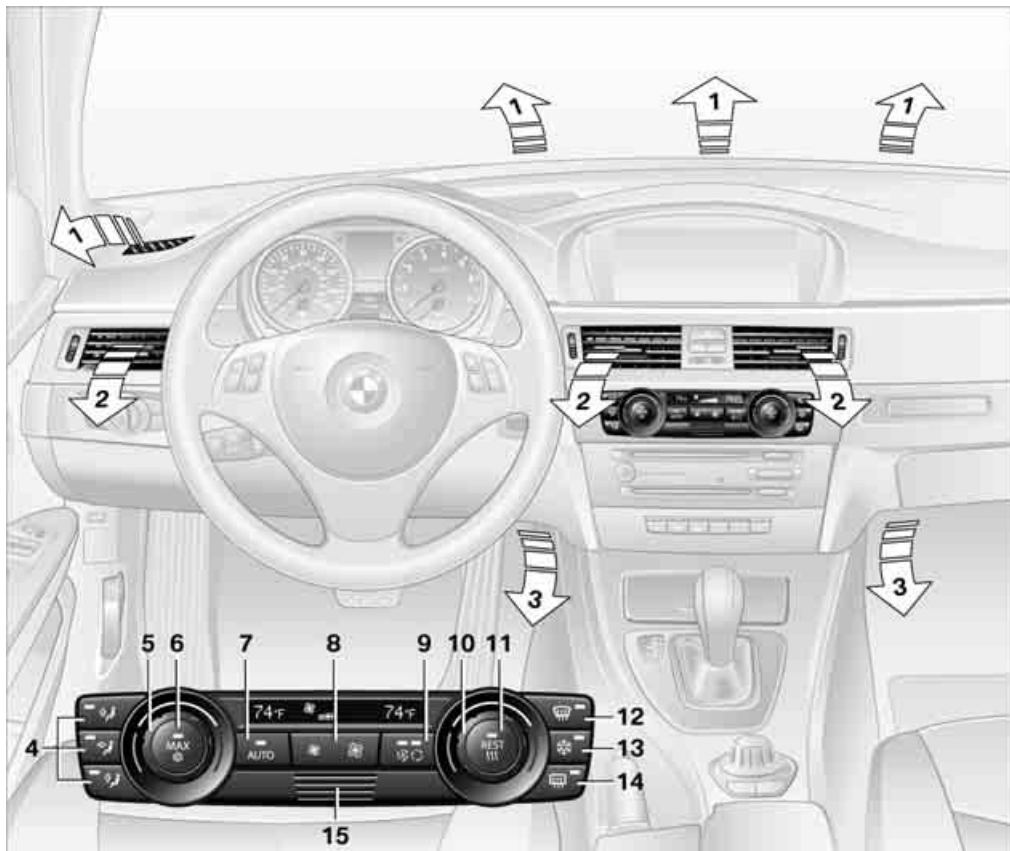

- | | |
|-----------------------------------------------------------------------------------------------------------------------------------------------------------------------------------------------------------------------------------------------------------------------------------------------------------------------------------------------------------------------------------------------------------------------------------------------------------------------------------------------------------------|--------------------------------------------------------------------------------------------------------------------------------------------------------------------------------------------------------------------------------------------------------------------------------------------------------------------------------------------------------------------------------------------------------------------------------------------------------------------------------------------------------------------------|
| <ul style="list-style-type: none"> 1 Airflow directed toward the windshield and side windows 2 Air to the upper body area
Draft-free ventilation 104 3 Air to the footwell 4 Air distribution, manual 5 Temperature adjustment, left-hand side of passenger compartment 6 Maximum cooling 7 AUTO program 8 Air flow rate, manual 9 AUC Automatic recirculated-air control/
Recirculated-air mode | <ul style="list-style-type: none"> 10 Temperature adjustment, right-hand side of passenger compartment 11 Residual heat 12 Defrosting windows and removing condensation 13 Switching cooling function on/off manually 14 Rear window defroster 15 Air grill for interior temperature sensor – please keep clear and unobstructed <p>The current setting for the air distribution is displayed on the Control Display, refer to page 102.</p> |
|-----------------------------------------------------------------------------------------------------------------------------------------------------------------------------------------------------------------------------------------------------------------------------------------------------------------------------------------------------------------------------------------------------------------------------------------------------------------------------------------------------------------|--------------------------------------------------------------------------------------------------------------------------------------------------------------------------------------------------------------------------------------------------------------------------------------------------------------------------------------------------------------------------------------------------------------------------------------------------------------------------------------------------------------------------|

Automatic climate control

Comfortable interior climate

AUTO program 7 offers the ideal air distribution and air flow rate for almost all conditions, refer to AUTO program below. All you need to do is select an interior temperature which is comfortable for you.

The following sections inform you in detail about how to adjust the settings.

Most settings are stored for the remote control currently in use, refer also to Personal Profile settings on page 28.

Adjusting air distribution manually



The air distribution can be switched on and off manually. The air is directed to the windshield, to the upper body area and to the footwell. Automatic air distribution adjustment is deactivated.

You can switch the automatic air distribution back on by pressing the AUTO button. This automatically switches on the cooling function as well.

Fine adjustments to manual air distribution

You can set the rate of incoming airflow for manual air distribution.

iDrive, for operating principle refer to page 16.

1. Press the **MENU** button.
This opens the start menu.
2. Move the controller to the left to call up "Climate".

3. Select "Vent settings" and press the controller.

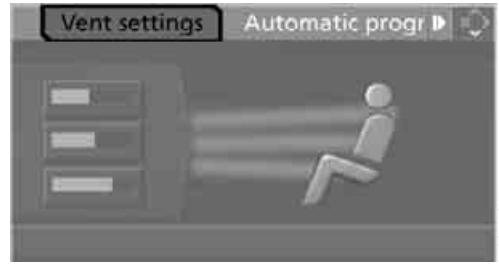

4. Select the desired field.
5. Turn the controller to set the air distribution.

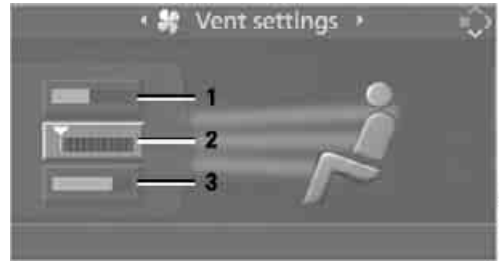

- 1 Airflow directed toward the windshield and side windows
- 2 Air to the upper body area
- 3 Air to the footwell

Temperature



Set the desired temperatures individually for the driver's and front passenger's sides.

The automatic climate control achieves this temperature as quickly as possible regardless of the season, using maximum cooling or heating power if necessary, and then maintains it.

▶ When you switch between different temperature settings in quick succession, the automatic climate control does not have enough time to achieve the set temperature. ◀

Maximum cooling



At outside temperatures above 32 °F/0 °C and when the engine is running, you obtain a maximum cooling effect as soon as possible.

The automatic climate control switches to the lowest temperature and operates in recirculated-air mode. Air flows at maximum rate only from the vents for the upper body area. You should therefore open them for maximum cooling.

AUTO program



The AUTO program adjusts the air distribution to the windshield and side windows, towards the upper body area and into the footwell for you. The air flow rate and your temperature specifications will be adapted to outside influences as a result of seasonal changes, e.g. sunlight or window condensation.

The cooling is switched on automatically with the AUTO program.

Intensity of the AUTO program

You can set the intensity of the air supply in the AUTO program. This changes the duration of time during which the vehicle interior is heated or cooled.

1. Press the **MENU** button. This opens the start menu.
2. Move the controller to the left to call up "Climate".
3. Select "Automatic programs" and press the controller.
4. Select the desired intensity and press the controller.

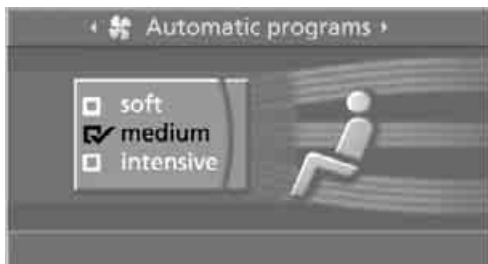

 The selected intensity level of the automatic program is switched on.

Adjusting air flow rate manually



Press the left side of the button to reduce airflow. Press the right side of the button to increase it.

You can reactivate the automatic mode for the air flow rate with the AUTO button.

Switching the system on/off

With the blower at its lowest setting, press the left side of the button to switch off the automatic climate control. All indicators go out.

Press any button except REST to reactivate the automatic climate control.

AUC Automatic recirculated-air control/Recirculated-air mode



Switch on the desired operating mode by pressing this button repeatedly:

- ▷ LED off: outside air flows in continuously.
- ▷ Left-hand LED on, AUC mode: a sensor detects pollutants in the outside air. If necessary, the system blocks the supply of outside air and recirculates the inside air. As soon as the concentration of pollutants in the outside air has decreased sufficiently, the system automatically switches back to outside air supply.
- ▷ Right-hand LED on, recirculated-air mode: the supply of outside air is permanently shut off. The system then recirculates the air currently within the vehicle.

 If condensation starts to form on the inside window surfaces during operation in the recirculated-air mode, you should switch it off while also increasing the air flow rate as required.

The recirculated-air mode should not be used over an extended period of time, otherwise the air quality inside the car will deteriorate continuously. ◀

Via the button* on the steering wheel

You can switch quickly between the recirculated-air mode and the previous mode using an individually programmable button on the steering wheel, refer to page 11.

Residual heat



The heat stored in the engine is used to heat the passenger compartment, e.g. while stopped at a school to pick up a child.

The function can be switched on when the following conditions are met:

- ▷ Up to 15 minutes after the engine has been switched off
- ▷ While the engine is at operating temperature
- ▷ As long as battery voltage is sufficient
- ▷ At an outside temperature below 77 °F / 25 °C

The LED is lit when the function is on.

As of radio readiness, you can set the interior temperature, the air flow rate and the air distribution.

Defrosting windows and removing condensation



Quickly removes ice and condensation from the windshield and front side windows.

Switching cooling function on/off



The cooling function cools and dehumidifies the incoming air before also reheating it as

required, according to the temperature setting. Depending on the weather, the windshield may fog over briefly when the engine is started.

The cooling function is automatically switched on along with the AUTO program. The passenger compartment can only be cooled while the engine is running.

Rear window defroster



The defroster switches off automatically after a certain time.

Ventilation



- 1 Use the knurled wheels to smoothly open and close the air vents
- 2 Use the lever to change the direction of the airflow
- 3 Knurled wheel for more or less cool air from the vents for the upper body area

Ventilation for cooling

Adjust the vent outlets to direct the flow of cool air in your direction, for instance if it has become too hot in the car.

Draft-free ventilation

Set the vent outlets so that the air flows past you and not straight at you.

Ventilation in the rear

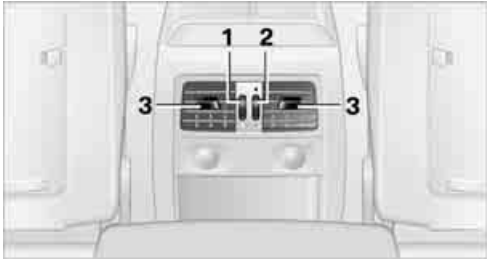

- 1 Use the knurled wheel to smoothly open and close the air vents
- 2 Use the knurled wheel to adjust the temperature:
 - ▷ Turn toward blue: colder
 - ▷ Turn toward red: warmer
- 3 Use the lever to change the direction of the airflow

Microfilter/activated-charcoal filter

The microfilter traps dust and pollen in the incoming air. The activated-charcoal filter provides additional protection by filtering gaseous pollutants from the outside air. Your BMW center replaces this combined filter during routine maintenance.

You can call up further information in the service requirements display, refer to page 77.

Parked car ventilation

The concept

The parked car ventilation/heating provides ventilation to the passenger compartment and lowers its temperature, if necessary. It is ready for use at any outside temperature, as of radio readiness.

The parked car ventilation/heating remains switched on for 30 minutes. Two different switch-on times can be preselected. The system can also be switched on and off directly. Due to its high power consumption, it should not be switched on twice in a row without driving in between to allow the battery to recharge.

The air emerges from the air vents for the upper body area in the instrument panel. The air vents must therefore be open.

The parked car ventilation system is operated via iDrive.

Switching on/off directly

iDrive, for operating principle refer to page 16.

1. Open the start menu.
2. Move the controller to the left to call up "Climate".
3. Select "Parked car operation" and press the controller.
4. Select "Automatic ventilation" and press the controller.
5. Select "Parked car ventilation" and press the controller.

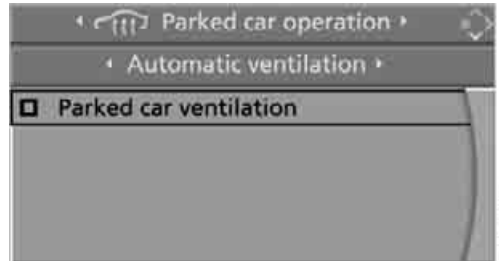

The parked car ventilation/heating is switched on.

 The symbol on the automatic climate control display flashes.

Preselecting switch-on times

iDrive, for operating principle refer to page 16.

1. Open the start menu.
2. Move the controller to the left to call up "Climate".
3. Select "Parked car operation" and press the controller.
4. Select "Activation time" and press the controller.

5. Move the controller to the left or right to select "Timer 1" or "Timer 2".

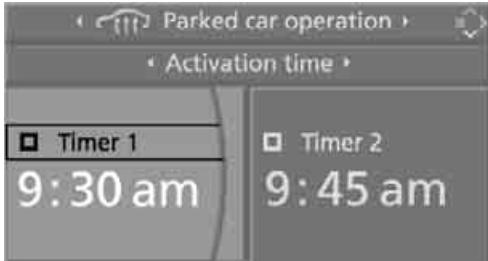

6. Select the time and press the controller. The first time setting is selected.

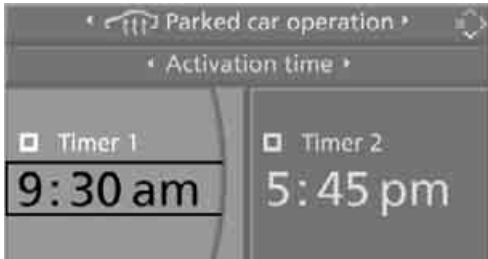

7. Turn the controller to make the adjustment.
8. Press the controller to apply the setting. The next setting is highlighted.
9. Make the remaining adjustments. After the last adjustment, the time is stored.

Activating switch-on times

Move the controller to the left or right to select "Timer 1" or "Timer 2" and then press the controller.

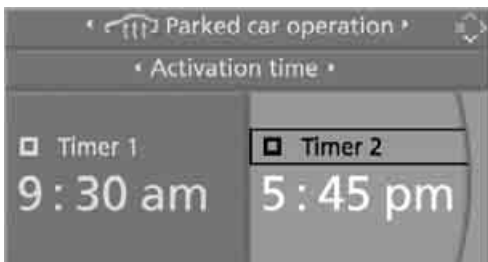

- ✓ The switch-on time is activated.

☞ The symbol on the automatic climate control display lights up.

☞ The symbol on the automatic climate control display flashes when the system has switched on.

▶ The respective system only switches on within the next 24 hours. After these have elapsed, it must be reactivated. ◀

Practical interior accessories

Integrated universal remote control*

The concept

The integrated universal remote control can replace as many as three hand-held transmitters for various remote-controlled devices, such as door openers and house alarm systems. The integrated universal remote control registers and stores signals from the original hand-held transmitters.

The signal of an original hand-held transmitter can be programmed on one of the three memory buttons **1**. After this, the programmed memory button **1** will operate the system in question. The LED **2** flashes to confirm transmission of the signal.

Should you sell your vehicle one day, be sure to delete the stored programs beforehand for your safety, refer to page **108**.

 To prevent possible damage or injury, before programming or using the integrated universal remote control, always inspect the immediate area to make certain that no people, animals or objects are within the pivoting or travel range of the device being operated. Comply also with the safety instructions supplied with the original hand-held transmitter. ◀

Checking compatibility

 If this symbol appears on the package or in the instructions supplied with the original hand-held transmitter, you can assume that the radio remote control device will be compatible with the integrated universal remote control.

For additional information, please contact your BMW center or call: 1-800-355-3515. You can also obtain information on the Internet at:

www.bmwusa.com or
www.homelink.com.

HomeLink is a registered trademark of Johnson Controls, Inc. ◀

Programming



- 1 Memory buttons
- 2 LED

Fixed-code hand-held transmitters

1. Switch on the ignition, refer to page **57**.
2. When starting operation for the first time: Press both outer memory buttons **1** for approx. 20 seconds until the LED **2** flashes. The three memory buttons are cleared.
3. Hold the original hand-held transmitter at a distance of approx. 2 to 8 in/5 to 20 cm from the memory buttons **1**.
 The required distance between the hand-held transmitter and the memory buttons **1** depends on the system of the respective original hand-held transmitter used. ◀
4. Simultaneously press the transmit key on the original hand-held transmitter and the desired memory button **1** on the integrated universal remote control. The LED **2** flashes slowly at first. As soon as the LED **2** flashes rapidly, release both buttons. If the LED **2** does not flash rapidly after approx. 15 seconds, alter the distance.
5. To program other original hand-held transmitters, repeat steps 3 and 4.

The corresponding memory button **1** is now programmed with the signal of the original hand-held transmitter.

You can operate the device while the ignition is switched off.

▶ If the device fails to function even after repeated programming, check whether the original hand-held transmitter uses an alternating-code system. To do so, either read the instructions for the original hand-held transmitter or hold down the programmed memory button **1** of the integrated universal remote control. If the LED **2** on the integrated universal remote control flashes rapidly for a short while and then remains lit for about two seconds, the original hand-held transmitter uses an alternating-code system. If it uses an alternating-code system, program the memory buttons **1** as described under Alternating-code hand-held transmitters.◀

Alternating-code hand-held transmitters

To program the integrated universal remote control, consult the operating instructions for the device to be set. You will find information there on the possibilities for synchronization. When programming hand-held transmitters that employ an alternating code, please observe the following supplementary instructions:

▶ Programming will be easier with the aid of a second person.◀

1. Park your vehicle within the range of the remote-controlled device.
2. Program the integrated universal remote control as described above in the section Fixed-code hand-held transmitters.
3. Locate the button on the receiver of the device to be set, e.g. on the drive unit.
4. Press the button on the receiver of the device to be set. After step 4, you have approx. 30 seconds for step 5.
5. Press the programmed memory button **1** of the integrated universal remote control three times.

The corresponding memory button **1** is now programmed with the signal of the original hand-held transmitter.

▶ If you have any questions, please contact your BMW center.◀

Clearing the memory buttons

Press both outer memory buttons **1** for approx. 20 seconds until the LED **2** flashes: all memory buttons are cleared.

It is not possible to clear individual memory buttons.

Digital compass*

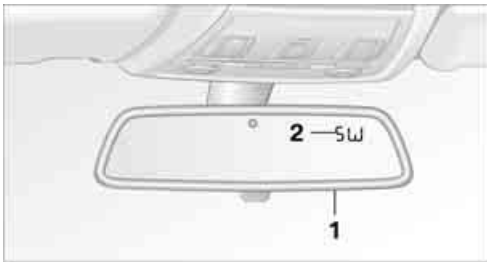

- 1 Adjustment button
- 2 Display

The display shows you the main or secondary compass direction in which you are driving.

Operating principle

You can call up various functions by pressing the adjustment button with a pointed object such as a pen or similar item. The following adjustment options are displayed one after the other, depending on how long you keep the adjustment button pressed:

- ▶ Press briefly: switch display on/off
- ▶ 3 to 6 seconds: set the compass zone
- ▶ 6 to 9 seconds: calibrate the compass
- ▶ 9 to 12 seconds: set left-hand/right-hand steering
- ▶ 12 to 15 seconds: set the language

Setting compass zones

Set the compass zone corresponding to your vehicle's geographic location so that the com-

pass can function correctly; refer to the world map with compass zones below.

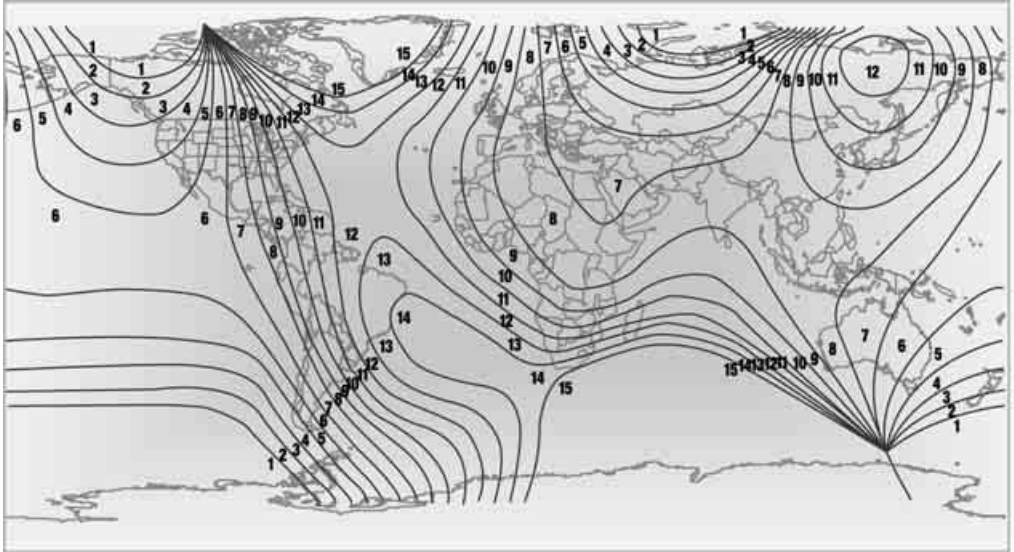

To set the compass zone, press the adjustment button for approx. 3-4 seconds. The number of the compass zone set is shown in the display.

To change the zone setting, briefly press the adjustment button repeatedly until the display shows the number of the compass zone corresponding to your current location.

The compass is operational again after approx. 10 seconds.

your vehicle and that you have enough space to drive in a circle.

2. Set the currently valid compass zone.
3. Press the adjustment button for approx. 6-7 seconds to call up C. Then drive in at least one full circle at a speed of no more than 4 mph or 7 km/h. If calibration is successful, the display changes from C to a compass direction.

Calibrating the digital compass

The digital compass must be calibrated in the following situations:

- ▷ An incorrect compass direction is shown.
- ▷ The compass direction shown does not change although the direction of travel does.
- ▷ Not all compass directions are shown.

Procedure

1. Make sure that no large metal objects or overhead power lines are in the vicinity of

Setting right-hand/left-hand steering

Your digital compass is factory-set to right-hand or left-hand steering, in accordance with your vehicle.

Setting the language

You can set the language of the display:

Press the adjustment button for approx. 12-13 seconds. Briefly press the adjustment button again to switch between English, "E", and German, "O".

The setting is automatically saved after approx. 10 seconds.

Roller sun blinds*

Rear window blind

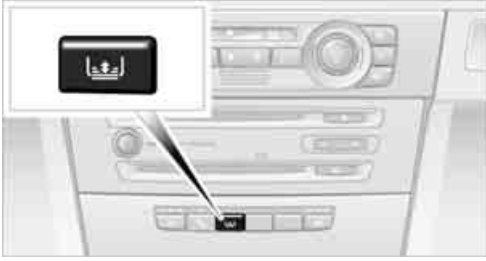

Tap the button in the center console to raise or lower the roller sun blind.

Roller sun blinds for rear side windows

Pull loop of roller sun blind and hook onto bracket.

Glove compartment

Opening



Pull the handle.

The light in the glove compartment switches on.

⚠ To prevent injury in the event of an accident while the vehicle is being driven, close the glove compartment immediately after use. ◀

Closing

Fold cover up.

Locking

To lock the glove compartment, use the integrated key of the remote control, refer to page 28.

Rechargeable flashlight

It is on the left-hand side of the glove compartment. The flashlight can remain plugged in. Whenever required, pull the flashlight out of its socket.

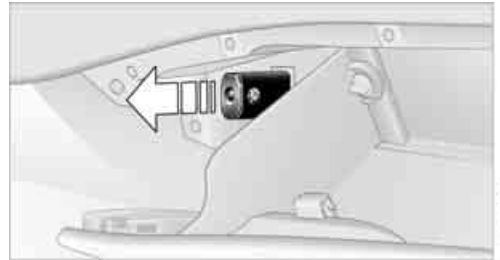

⚠ Only insert the flashlight back into the socket when it is switched off, otherwise there is a risk of damage. ◀

Center armrest

Storage compartment

The center armrest between the front seats contains either a compartment or the cover for the snap-in adapter*, depending on the equipment version. For more information about this mobile phone bracket refer to the separate Owner's Manual.

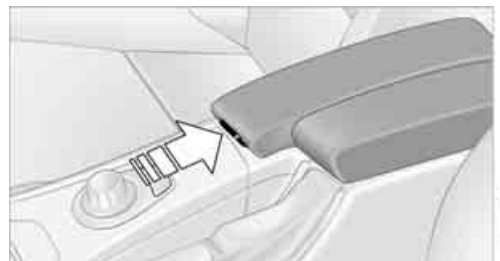

Opening

Press the button, see arrow.

Ventilated storage compartment



The storage compartment in the center armrest can be ventilated: slide the switch backwards.

The temperature is controlled via the knurled wheel for adjusting the temperature of air ventilating the rear of the passenger compartment, refer to page 105.

Connection for external audio device

You can connect an external audio device such as a CD or MP3 player and play audio tracks over the car's loudspeaker system, refer to page 173.

Storage compartments inside the vehicle

Depending on your vehicle's equipment, you will find compartments beside the steering column*, in the front doors and in the center console*.

There are nets* on the front-seat backrests.

Clothes hooks

There are clothes hooks on the grab handles in the rear passenger compartment.

 Items of clothing hung from the hooks must not obstruct the driver's view. Do not hang heavy objects from the hooks, otherwise they could endanger the car's occupants, e.g. in case of heavy braking or sudden swerving. ◀

Cup holders

 Use lightweight and breakproof containers. Otherwise there is an increased risk of injury in the event of an accident. Do not force containers that are too large into the cup holders, otherwise damage could result. ◀

Front

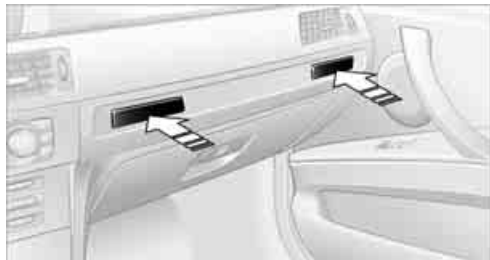

Opening

Briefly press the center of the cover.

Closing

Briefly press the cover in the center and push in the cup holder.

Rear

There are two additional cup holders in the rear center armrest.



Press the front of the armrest.

Ashtray, front

Opening



Push the ridge on the cover.

Emptying



Lift out the insert.

Lighter



With the engine running or the ignition switched on, press in the cigarette lighter.

The lighter can be pulled out as soon as it pops back out.

⚠ Hold or touch the hot cigarette lighter by the knob only. Holding or touching it in other areas could result in burns.

When leaving the car, always remove the

remote control so that children cannot operate the cigarette lighter and burn themselves. ◀

Ashtray, rear

Opening

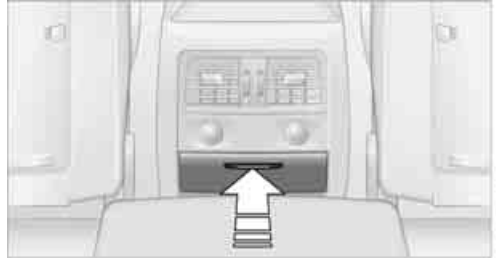

Push the ridge on the cover.

Emptying

Lift out the insert.

Connecting electrical appliances

In your BMW, you can use electrical devices such as a flashlight, car vacuum cleaner, etc., up to approx. 200 watts at 12 volts, as long as one of the following sockets is available. Avoid damaging the sockets by attempting to insert plugs of unsuitable shape or size.

Cigarette lighter socket*

To access the socket: take the cigarette lighter out of the socket.

Socket in the center armrest

External audio device, refer to page 111.

Sockets in the rear center console*

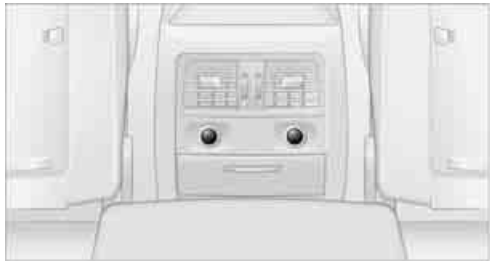

Remove corresponding cover.

Socket in the cargo bay*

Sedan



Sports Wagon



Open the cap.

Sedan: Through-loading system*

Opening

1. Open the belt lock of the rear center safety belt. To do so, press the button, see arrow, and release the latch plate.

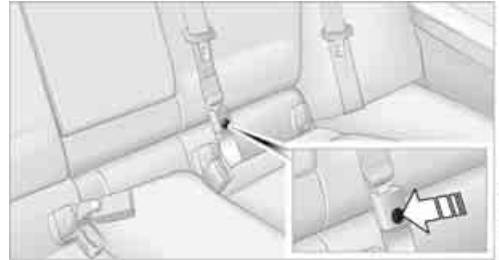

2. Insert the latch plate at the end of the belt into the specially designated fixture on the rear window shelf.

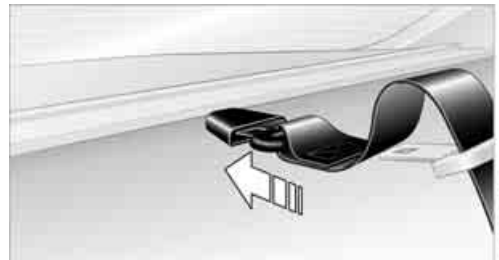

3. Push the corresponding head restraint down as far as it will go, refer to page 47.
4. To release the rear seat backrest, pull the corresponding lever in the cargo bay.

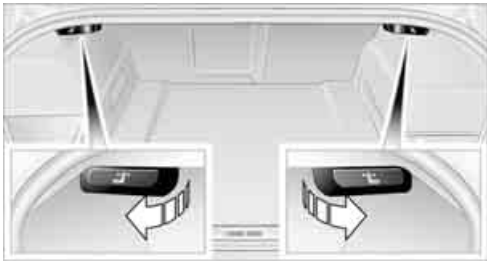

- The unlocked rear seat backrest moves forward slightly. Fold the backrest forward by the head restraint.

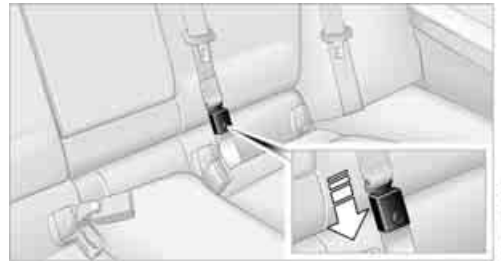

The lashing eyes in the cargo bay provide you with a way to attach cargo-bay nets* or draw straps for securing suitcases and luggage, refer to page 125.

Sports Wagon: Cargo bay

! Make sure that no fluids are leaking in the cargo bay; otherwise the vehicle could be damaged. ◀

Closing

- Return the rear seat backrest to its upright position and engage it.

! When returning the backrest into its seating position, make sure that the seat's locking mechanism engages properly. Otherwise, cargo could be thrown around in the event of sharp braking or swerving and endanger the occupants. ◀

- Release the latch plate from the fixture on the rear window shelf and insert it into the belt lock of the center safety belt. Make sure you hear the latch plate engage in the belt buckle.

Roll-up cover

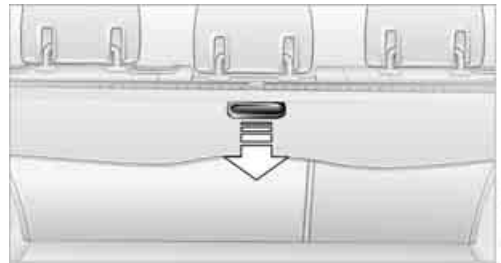

Pull out the cover and hook it into the retaining fixtures.

! Do not place objects on the cover, otherwise they could endanger the car's occupants, e.g. in the case of braking or sudden swerving.

Do not let the cover retract, otherwise it could be damaged. ◀

▷ The roll-up cover is raised when the rear window or tailgate is opened*. Before closing the rear window or tailgate, press the roll-up cover downward until it engages. ◀

Expanding the cargo bay

The rear seat backrest is divided. You can fold down either division in order to expand the cargo bay.



Reach into the recess and pull forwards.

⚠ When folding the backrest back up, make sure that the catch engages properly. If you cannot see a red warning area in the recess, the catch is properly engaged. Otherwise, cargo can be thrown around inside the passenger compartment and endanger the car's occupants, e.g. in the case of braking or sudden swerving. ◀

⚠ Observe the instructions concerning the safety belt on page 44 to ensure the best possible personal protection. ◀

Partition net

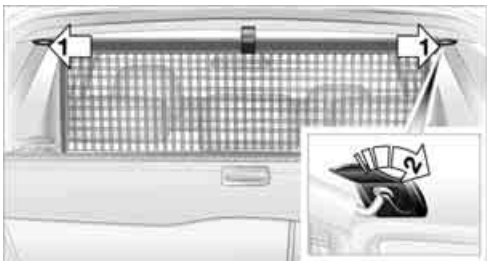

⚠ Do not let the partition net retract, otherwise there is a risk of danger and the partition net could be damaged. ◀

Use the loop strap to pull the partition net out of the casing. Grip the bar on both ends and insert it into the retaining fixtures, arrow 1. This can best be done from the rear seat.

When you no longer require the partition net, grip both ends of the bar and take it out of the

retaining fixtures, arrow 2. Let the partition net slide into the casing slowly.

With cargo bay expanded

1. Fold down both rear seat backrests, refer to Expanding the cargo bay.
2. Use the buttons to unlatch the casing on both sides, arrow 1.

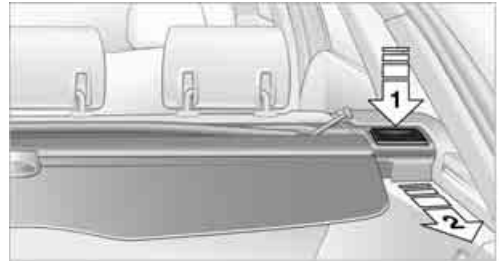

3. Pull the casing out backwards, arrow 2, without tilting it.

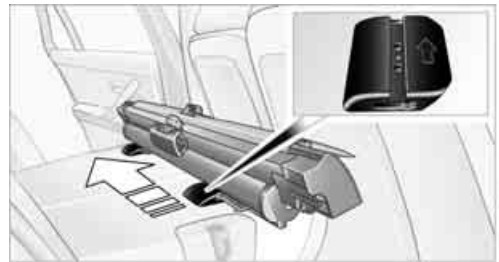

4. Slide the casing into the guides on the backs of the seat backrests.
5. Carefully pull out the partition net and insert it into the front retaining fixtures, refer to Partition net above. This can best be done from the front seat.

Follow the same steps in reverse order to return the partition net and seats to their original positions. Finally, slide the casing into both retaining fixtures on the sides until it engages. Tug on the casing to check if it is properly locked in place.

Storage compartments inside the cargo bay

Sedan

Depending on your vehicle's equipment, the following storage spaces can be found in the cargo bay:

- ▷ Left storage compartment, e.g. for storing a box of cleaning tissues or up to 12 CD jackets, depending on vehicle equipment version
- ▷ Net* for securing smaller objects, to be attached to the fixtures on the floor panel
- ▷ Hooks for hanging up, e.g., shopping bags or tote bags
- ▷ Rubber strap on the left trim panel for securing small objects such as a folding umbrella
- ▷ Net for small objects on the right trim panel of the cargo bay
- ▷ Retaining straps next to the rear lashing eyes, e.g. for securing an umbrella
- ▷ Folding, removable box* under the floor panel, e.g. for wet or dirty items
- ▷ Storage compartment under the floor panel
- ▷ Insertable dividers* and removable storage tray for the storage compartment under the floor panel
- ▷ Drawer for storing small items. Pull the handle firmly to release the drawer. If necessary, you can pull out the drawer entirely, refer to the information below

 Do not drive or close the luggage compartment lid while the drawer is pulled out.

On uphill gradients, release the drawer with caution, otherwise it could slide out on its own and cause injury.

Do not exceed a maximum load of 11 lbs/5 kg for the drawer, otherwise damage could result. ◀

Removing the drawer

1. Push the drawer all the way in.
2. Turn the catches on the left and right all the way out.



3. Remove the drawer by pulling it down and backwards.

Reinserting the drawer

1. Hook the guides of the drawer into the front of the yellow guide aids on the bottom of the cargo bay.
2. Insert the catches into the mounts on the bottom of the cargo bay.
3. Turn the catches on the left and right all the way in.

Sports Wagon

The following storage spaces can be found in the cargo bay:

- ▷ Umbrella holder on the bottom of the partition net casing



- ▷ Rubber strap on the left and right trim panel for securing small objects such as a folding umbrella

- ▷ Hooks for hanging up shopping bags or tote bags, for example, on the left and right-hand sides of the cargo bay
 - ▷ Net for small objects on the right trim panel of the cargo bay
 - ▷ Storage compartment under the floor panel
- Depending on your vehicle's equipment, other storage spaces can be found in the cargo bay:

- ▷ Net* for securing smaller objects, to be attached to the fixtures on the floor panel
- ▷ Net* on the left side trim of the cargo bay instead of the rubber strap
- ▷ Reversible cargo area floor panel with integrated plastic cover* for cargo bay or bumper
- ▷ Folding, removable box* under the floor panel, e.g. for wet or dirty items
- ▷ Insertable dividers* and removable storage tray for the storage compartment under the floor panel

Folding up the floor panel

 Do not exceed the maximum permissible load of 55 lbs/25 kg for the storage compartment under the floor panel, otherwise damage could result. ◀

Sedan

Press the floor panel against the ceiling of the cargo bay; a locking device holds the floor panel in place. To detach the floor panel, pull it out of the locking device.

Equipment version with drawer:

Take the retaining strap on the right-hand side of the drawer out of the bracket and use it to fix the floor panel in place.

Sports Wagon

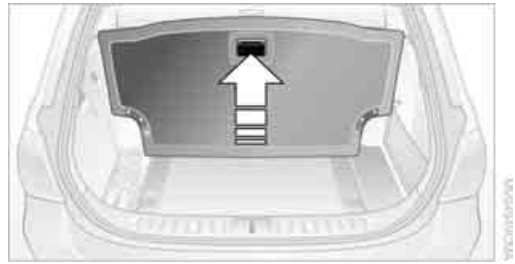

Fold up the floor panel and take it out or lean it forward.

Lashing eyes

You will find lashing eyelets in the cargo bay for securing luggage items with nets or tensioning straps, refer to page 125.

Ski bag*

Designed for safe, clean transport of up to 4 pairs of standard skis or up to 2 snowboards.

With the ski bag you can stow skis with a length of up to 6 ft 10 in/2.10 m. When skis of 6 ft 10 in/2.10 m length are loaded, the overall capacity of the ski bag is reduced due to its tapered design.

Loading

1. Fold down the center armrest.
2. Press the button, reach into the recess and fold down the cover.



3. Open the Velcro fastener, spread the ski bag between the front seats and insert the skis or snowboards.

The zip fastener makes objects in the ski bag easier to reach.

4. Insert the latch plate of the ski bag's retaining strap in the center belt buckle.



Only place clean skis in the ski bag. Wrap sharp edges to prevent damage.

Securing cargo

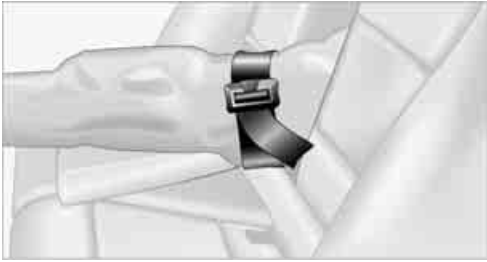

After loading, secure the ski bag and its contents. Tighten the retaining strap on the tensioning buckle for this purpose.

 Secure the ski bag in the manner described, otherwise it could endanger the car's occupants, e.g. in case of heavy braking or sudden swerving. ◀

To store the ski bag, perform the steps described for loading in reverse order.

Removing the ski bag

The ski bag can be completely removed, e.g. for faster drying or to allow you to use other inserts.

1. Fold down the center panel in the rear seat backrest.
2. Pull the handle, arrow 1.

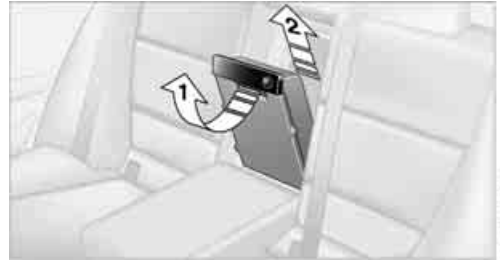

3. Pull out the insert, arrow 2.

 For more information on the various inserts available, contact your BMW center. ◀



Driving tips

This section provides you with information useful in dealing with specific driving and operating conditions.

Things to remember when driving

Break-in period

Moving parts need breaking-in time to adjust to each other. Please follow the instructions below in order to achieve the optimal service life and economy of operation for your vehicle.

Engine and differential

Always obey all official speed limits.

Up to 1,200 miles/2,000 km

Drive at varying engine and road speeds, but do not exceed an engine speed of 4500 rpm or a road speed of 100 mph/160 km/h.

Avoid full-throttle operation and use of the transmission's kick-down mode.

After driving 1,200 miles/2,000 km

Engine and vehicle speeds can be gradually increased.

Tires

Due to technical factors associated with their manufacture, tires do not achieve their full traction potential until after an initial break-in period. Therefore, drive cautiously during the first 200 miles/300 km.

Brake system

Brakes require an initial break-in period of approx. 300 miles/500 km to achieve optimized contact and wear patterns between brake pads and rotors. Drive cautiously during this break-in period.

Clutch

The function of the clutch reaches its optimal level only after a distance driven of approx. 300 miles/500 km. During this break-in period, engage the clutch gently.

Following part replacement

The same break-in procedures should be observed if any of the components mentioned above have to be renewed in the course of the vehicle's operating life.

General driving notes

Closing the luggage compartment lid/tailgate

 Operate the vehicle only when the luggage compartment lid/tailgate and rear window are closed. Otherwise, exhaust fumes could enter the interior of the vehicle. ◀

If special circumstances make it absolutely necessary to drive with the luggage compartment lid/tailgate or rear window open:

1. Close all windows and the glass sunroof.
2. Increase the air flow rate of the automatic climate control considerably, refer to page 103.

Hot exhaust system

 In all vehicles, extremely high temperatures are generated in the exhaust system. Do not remove the heat shields installed adjacent to various sections of the exhaust system, and never apply undercoating to them. When driving, standing at idle and while parking, take care to avoid possible contact between the hot exhaust system and any highly flammable materials such as hay, leaves, grass, etc. Such contact could lead to a fire, with the risk of serious personal injuries and property damage. Do not touch hot exhaust tail pipes. Otherwise there is a risk of burns. ◀

Mobile phone in the vehicle

 BMW discourages the use of mobile communications devices, e.g. mobile phones, inside the vehicle without a direct connection to an outside antenna. Otherwise, the

vehicle electronics and mobile communication device can influence one another. In addition, there is no assurance that the radiation which results from transmission will be dissipated from the vehicle interior. ◀

Hydroplaning

 When driving on wet or slushy roads, reduce road speed. If you do not, a wedge of water can form between tires and road surface. This situation, known as hydroplaning, means that the tire can completely lose contact with the road surface, so that neither the car can be steered nor the brake be properly applied. ◀

The risk of hydroplaning increases with declining tread depth on the tires, refer also to Minimum tread depth on page 211.

Driving through water

 Drive through water on the road only if it is not deeper than 1 ft/30 cm, and then only at walking speed at the most. Otherwise, the vehicle's engine, the electrical systems and the transmission may be damaged. ◀

Use the parking brake on inclines

 On inclines, do not hold the vehicle with the clutch; use the parking brake. Otherwise greater clutch wear will result. ◀

For more information about the drive-off assistant, refer to page 89.

Braking safely

Your BMW is equipped with ABS as a standard feature. Applying the brakes fully is the most effective way of braking in situations in which this is necessary. Since the vehicle maintains steering responsiveness, you can still avoid possible obstacles with a minimum of steering effort.

Pulsation of the brake pedal, combined with sounds from the hydraulic circuits, indicate that ABS is in its active mode.

Driving in wet conditions

When roads are wet or there is heavy rain, briefly exert gentle pressure on the brake pedal

every few miles. Monitor traffic conditions to ensure that this maneuver does not endanger other road users. The heat generated in this process helps dry the pads and rotors to ensure that full braking efficiency will then be available when you need it.

Hills

 To prevent overheating and the resulting reduced efficiency of the brake system, drive long or steep downhill gradients in the gear in which the least braking is required. Even light but consistent brake pressure can lead to high temperatures, brake wear and possibly even brake failure. ◀

You can increase the engine's braking effect by shifting down, all the way to first gear if necessary. This strategy helps you avoid placing excessive loads on the brake system. Downshifting in manual mode of the automatic transmission, refer to page 60.

 Never drive with the clutch held down, with the transmission in idle or with the engine switched off; otherwise, engine braking action will not be present or there will be no power assistance to the brakes or steering. Never allow floor mats, carpets or any other objects to protrude into the area around the pedals, otherwise pedal function could be impaired. ◀

Corrosion on brake rotors

When the vehicle is driven only occasionally, during extended periods when the vehicle is not used at all, and in operating conditions where brake applications are less frequent, there is an increased tendency for corrosion to form on rotors, while contaminants accumulate on the brake pads. This occurs because the minimum pressure which must be exerted by the pads during brake applications to clean the rotors is not reached.

Should corrosion form on the brake rotors, the brakes will tend to respond with a pulsating effect that even extended application will fail to cure.

When the vehicle is parked

Condensation forms while the automatic climate control is in operation, and then exits under the vehicle. Traces of condensed water under the vehicle are therefore normal.

Before driving into a car wash

For general information about taking care of your BMW, refer to the Caring for your vehicle brochure.

Sports Wagon: rear window wiper

Driving through an automatic car wash can result in damage to the rear window wiper. If necessary, ask the operator of the car wash about protective measures you should take.

With convenient access and automatic transmission

Insert the remote control into the ignition switch.

The engine can be switched off when the selector lever is in position N. Refer also to page 38.

Cargo loading

 To avoid loading the tires beyond their approved carrying capacity, never overload the vehicle. Overloading can lead to overheating and increases the rate at which damage develops inside the tires. The ultimate result can assume the form of a sudden blow-out. ◀

Determining loading limit



1. Locate the following statement on your vehicle's placard*:
 The combined weight of occupants and cargo should never exceed XXX kg or YYY lbs. Otherwise, overloading can result in damage to the vehicle and unstable driving conditions. ◀
2. Determine the combined weight of the driver and passengers that will be riding in your vehicle.
3. Subtract the combined weight of the driver and passengers from XXX kilograms or YYY pounds.
4. The resulting figure equals the available amount of cargo and luggage load capacity. For example, if the YYY amount equals 1,400 lbs. and there will be five 150-lb. passengers in your vehicle, the amount of available cargo and luggage load capacity is 650 lbs:
 $1,400 \text{ lbs.} - 750 \text{ lbs.} = 650 \text{ lbs.}$
5. Determine the combined weight of luggage and cargo being loaded on the vehicle. That weight may not safely exceed the available cargo and luggage load capacity calculated in step 4.
6. If your vehicle will be towing a trailer, part of the load from your trailer will be transferred to your vehicle. Consult the manual for transporting a trailer to determine how this may reduce the available cargo and luggage load capacity of your vehicle.

Load

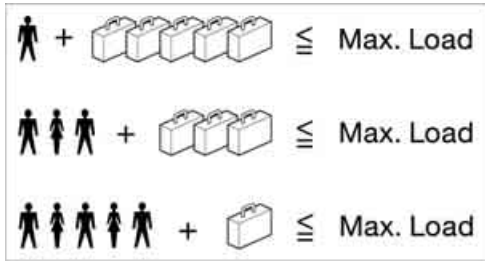

The permissible load is the total of the weight of occupants and cargo/luggage. The greater the weight of the occupants, the less cargo/luggage can be transported.

Stowing cargo

- ▷ Position heavy objects as low and as far forward as possible, ideally directly behind the respective seat backrests.
- ▷ Cover sharp edges and corners.
- ▷ For very heavy cargo when the rear seat is not occupied, secure each safety belt in the opposite buckle.

Sedan

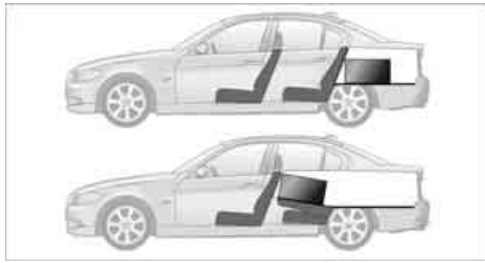

Sports Wagon

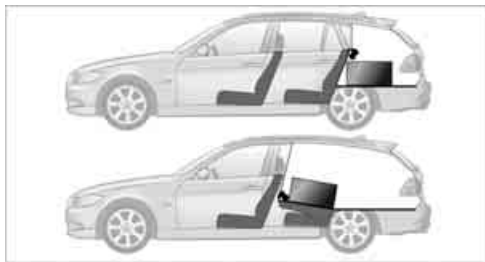

- ▷ Use the partition net to protect passengers, refer to page 115. Make sure that objects cannot penetrate the partition net.
- ▷ Do not stack cargo higher than the upper edge of the backrests.
- ▷ Place protective material around any objects which could bump against the rear window while the vehicle is in motion.

Securing cargo

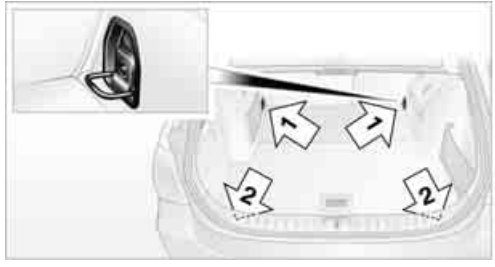

- ▷ Secure smaller and lighter items using retaining straps, a cargo-bay net* or draw straps*.
- ▷ Heavy-duty cargo straps* for securing larger and heavier objects are available at your BMW center. Four lashing eyes are provided for attaching the cargo straps. Two are located on the cargo-bay sidewalls 1, two more are on the rear cargo-bay panel 2. Please comply with the information supplied with the cargo straps.

⚠ Always position and secure the cargo as described above, so that it cannot endanger the car's occupants, for example if sudden braking or swerves are necessary. Never exceed either the approved gross vehicle weight or either of the approved axle loads, refer to page 239, as excessive loads can pose a safety hazard, and may also place you in violation of traffic safety laws. Heavy or hard objects should not be carried loose inside the car, since they could be thrown around, for example as a result of heavy braking, sudden swerves, etc., and endanger the occupants. ◀

Roof-mounted luggage rack*

A special rack system is available as an option for your BMW. Comply with the directions given in the installation instructions.

Mounting points

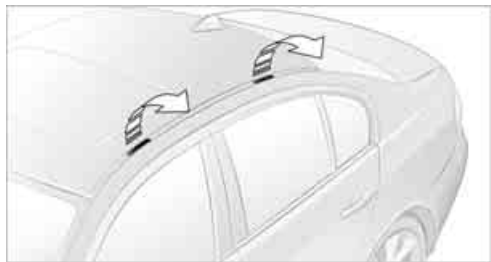

The mounting points are located in the roof/along the roof rails*.

Loading roof-mounted luggage rack

Because roof racks raise the vehicle's center of gravity when loaded, they have a major effect on vehicle handling and steering response.

You should therefore always remember not to exceed the approved roof load capacity, the approved gross vehicle weight or the axle loads when loading the rack.

You can find the applicable data under Weights on page [239](#).

The roof load must be distributed uniformly and should not be too large in area. Heavy items should always be placed at the bottom. Be sure that adequate clearance is maintained for raising the glass sunroof, and that objects do not project into the opening path of the luggage compartment lid/tailgate.

Fasten roof-mounted cargo correctly and securely to prevent it from shifting or falling off during the trip.

Drive smoothly. Avoid sudden acceleration and braking maneuvers. Take corners gently.



Navigation

This chapter describes how you can enter destinations and specify your route so that your navigation system guides you reliably to your destination.

Starting the navigation system*

Your navigation system can use satellites to ascertain the precise position of your vehicle and guide you reliably to any destination you enter.

Navigation DVD

The navigation system requires a special navigation DVD. You can obtain the latest version at your BMW center.

Inserting navigation DVD



Use the lower drive for navigation DVDs.

1. Insert the navigation DVD with the labeled side up.
The navigation DVD is pulled in automatically.
2. Wait for several seconds to allow the contents of the DVD to be read in.

Removing navigation DVD

1.  Press button **1**.
The DVD emerges slightly from the drive.
2. Remove the DVD.

If the DVD is not ejected from the drive, it is possible that it is blocked. A message appears on the Control Display.

Display in the assistance window

You can display the route or the current position in the assistance window. This display remains visible even if you change to another application.

1. Move the controller to the right to enter the assistance window.



2. Press the controller.
Other menu items are displayed.
3. Select the desired route view or "Current position".



4. Press the controller.

Destination entry

In entering your destination you can select from the following options:

- ▷ Entering a destination manually, see below
- ▷ Entering a destination by voice commands*, refer to page 134
- ▷ Selecting destination using information, refer to page 137
- ▷ Selecting destination from a list, refer to Destination list, page 138
- ▷ Selecting destination from address book, refer to page 138
- ▷ Selecting home address, refer to page 140

After selecting your destination you can proceed to start the destination guidance, refer to page 143.

Operating navigation system

 Enter data only when the vehicle is stationary, and always give priority to the applicable traffic regulations in the event of any contradiction between traffic and road conditions and the instructions issued by the navigation system. If you do not observe this precaution, you may be in violation of the law, and can endanger vehicle occupants and other road users. ◀

iDrive, for operating principle refer to page 16.

1. Press the **MENU** button.
This opens the start menu.
2. Move the controller to the right to call up "Navigation".



3. Select "Navigation" and press the controller.

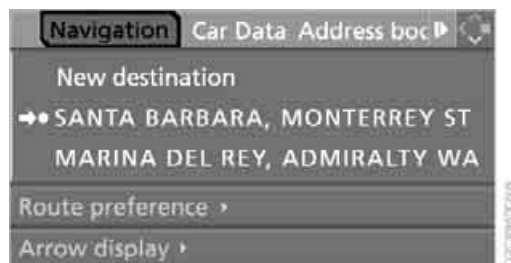

Entering a destination manually

The system's word-matching principle makes it easier for you to enter the names of streets or towns, refer to page 142. This allows you to enter different spellings and completes your entry automatically so that stored names can be called up quickly.

1. If necessary, move the highlight marker to the uppermost field. Turn the controller until "Navigation" is selected and press the controller.
"New destination" is selected.
2. Press the controller.



3. Select "Enter address" and press the controller.



The system also supports you with the following features:

- ▷ If you do not enter a street, the system will guide you to the downtown area of a town or city.
- ▷ You can skip the entry of country and locality if the current entries should be retained for your new destination.

Selecting country

1. Select "State / Province" or the country displayed and press the controller.
The list of available countries appears on the display.

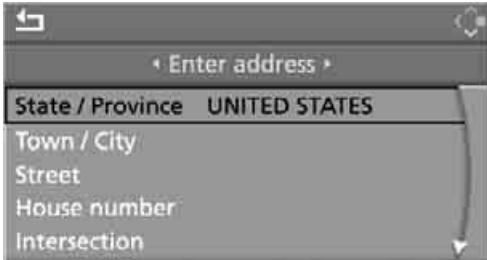

2. Select the country of destination and press the controller.

At least the town/city of the destination or its zip code must be entered in order to start the destination guidance.

Entering destination by town/city name

1. Select "Town / City" or the town/city displayed and press the controller.
2. Select the starting letter and press the controller.

A list of all towns/cities starting with this letter appears on the Control Display.

3. Delete letters, if necessary:



- ▷ To delete individual numbers or letters: Move the controller toward the right to select ←|, and press the controller.
 - ▷ To delete all numbers or letters: Move the controller toward the right to select ←|, and hold the controller down.
4. If necessary, enter more letters.
The list gradually grows smaller each time you enter a new letter.
 - ▷ To enter spaces, if necessary: Select the _ symbol and press the controller.

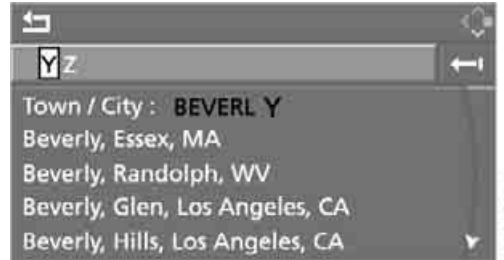

5. If necessary, move the highlight marker to the third field from the top. Turn the control-

ler until the city or town name is selected from the list and press the controller.

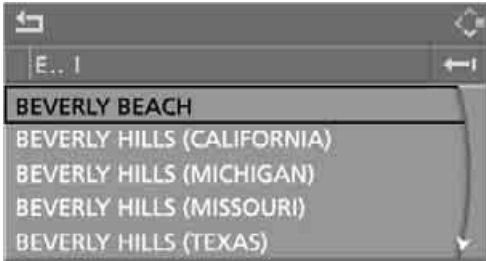

Entering destination by zip code

1. Select "Town / City" and press the controller.
2. Enter the zip code:
Select the desired digits and press the controller.

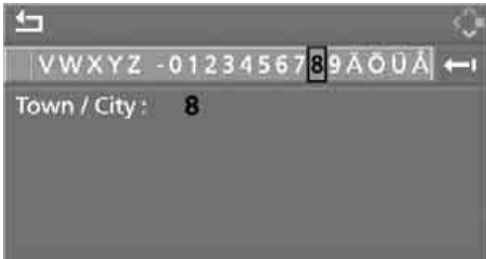

- ▷ To enter spaces:
Select the _ symbol and press the controller.
- ▷ To delete individual numbers or letters:
Move the controller toward the right to select ←, and press the controller.
- ▷ To delete all numbers or letters:
Move the controller toward the right to select ←, and hold the controller down.

3. Select the zip code and press the controller. The corresponding destination is displayed.
4. Move the highlight marker to the third field from the top. Turn the controller until the destination is selected and press the controller.

Entering street, house number and intersection

After the street you can also enter the intersection or the house number.

Entering street and intersection

1. Select "Street" or the street displayed and press the controller.
2. Enter the street.
The street is entered in the same manner as the town or city.



The intersection is entered in the same way as the street.

Entering a street without entering a town/city

You can also enter a street without specifying a town/city. In this case, all streets of the same name in the designated country are offered. The corresponding town/city is displayed after the street name.

If a town/city has already been entered, you can negate this entry. This could be helpful in instances where the desired street does not exist in the entered town/city because it belongs to another suburb, for example.

1. Move the highlight marker to the uppermost field.
The  arrow is highlighted.



2. Move the controller to the right until you see a request to enter a street in the country and press the controller.

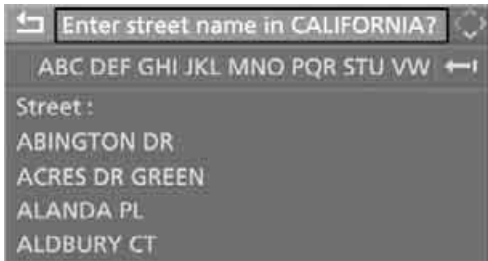

3. Switch to the second field from the top and enter the street.

Entering a house number

You can enter any house number stored for the street on the navigation DVD.

1. Select "House number" and press the controller.
2. To enter the house number:
Select the desired digits and press the controller.
3. Move the highlight marker to the third field from the top. Turn the controller until the house number is selected and press the controller.

Starting destination guidance with manual destination entry

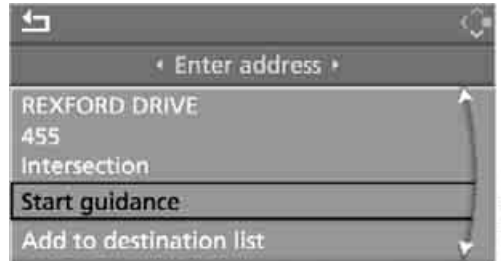

- ▶ Select "Start guidance" and press the controller.
Destination guidance starts immediately.
- ▶ If you do not want to start destination guidance right away:
Select "Add to destination list" and press the controller.
The destination is stored in the destination list, refer to page 138.

Entering a destination by voice commands*

You can enter a desired destination via the voice command system. During the destination input, you can switch between voice entry and entry via iDrive at any time. To do so, reactivate the voice command system if necessary.

 You can have the possible commands read aloud via **Options**.

1. Press the  button on the steering wheel or in the center console.
2. **Enter address**



Selecting country

1. Wait for the system to ask for the country of destination.

2. Say the name of the destination country.

Say the name of the destination country in the language of the voice command system.

Entering destination

The destination can be spelled or entered as an entire word.

Spelling the destination

To enter a destination, spell it in the way it is commonly spelled in the destination country. Pronounce the letters smoothly and at normal volume, avoiding excessive emphases and pauses.

1. To spell the name of a town/city: Say at least the first three letters of the town/city. The more letters you say, the more accurately the system will recognize the town/city.

The system can suggest up to 20 destinations that meet your entries. Up to 6 entries at a time appear on the Control Display.



The system suggests a location.

2. Selecting location:
 - ▶ To select highlighted town/city: ›Yes‹
 - ▶ To select other town/city: ›No‹
 - ▶ To select an entry, e.g. ›Entry 3‹
 - ▶ To show other entries in the list: ›Next page‹
 - ▶ To respell the town/city: ›Repeat‹

The town/city can also be selected from the list via iDrive:

Turn the controller until the destination is selected and press the controller.

Entering the destination as an entire word*

Towns/cities and streets located in the region where the language of the voice command system is spoken can be entered as an entire word.

Example: to enter a U.S. destination as an entire word, the system language must be English.

A prerequisite is the use of a suitable navigation DVD.

Speak smoothly and at normal volume, and avoid excessive emphases and pauses.

1. Wait for the system to ask for the town/city of destination.
2. Say the name of the destination town/city.

The system can suggest up to 6 destinations that meet your entries.



The system suggests a location.

3. Selecting location:
 - ▶ To select highlighted town/city: ›Yes‹
 - ▶ To select other town/city: ›No‹
 - ▶ To select an entry, e.g. ›Entry 3‹
 - ▶ To reenter the town/city: ›Repeat‹
 - ▶ To enter the town/city by spelling: ›Spell‹

The town/city can also be selected from the list via iDrive:

Turn the controller until the destination is selected and press the controller.

 Identical-sounding towns/cities that cannot be distinguished by the system are compiled in a separate list and shown as a destination followed by three dots. If applicable, select this entry with ›Yes‹. Then select the desired town/city from that list. ◀

Entering street and house number

The street is entered in the same way as the destination town/city.

To enter the house number:

1. ›House number‹
2. Say the house number.

House numbers of up to 4 digits can be entered. Say the house number as individual digits.

Starting destination guidance

 ›Start guidance‹

Destination guidance starts immediately.

Storing destinations

Destinations are added to the destination list or can be stored in the address book.

- ›Add to destination‹ or
- ›Add to address book‹

Map-guided destination selection

If you only know the location of the town or street of the destination, then you can enter the destination by using a map. You can use the cross-hairs to select the destination on the map and then transfer it for destination guidance.

1. Select "Navigation" and press the controller. "New destination" is selected.
2. Press the controller.

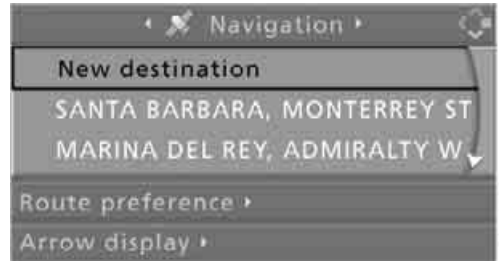

3. Select "Input map" and press the controller.

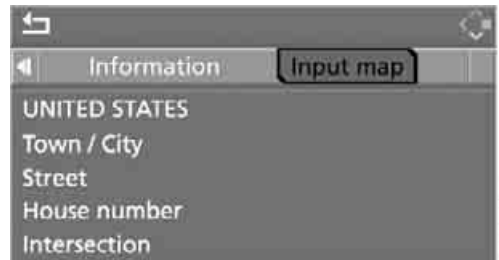

A section of a map is displayed on the Control Display:

- ▷ During destination guidance, around the current destination
- ▷ With the destination guidance deactivated, around the last destination entered



4. Select the destination with the cross-hairs.
 - ▷ To change scale: turn the controller.
 - ▷ To move the map: move the controller in the desired direction. The controller can be moved to the left,

right, forwards, backwards and also diagonally.

5. Press the controller to transfer the destination for destination guidance or to store it. The selected destination and other menu items are displayed.
6. Select the desired menu item:
 - ▷ "Start route guidance" starts destination guidance.
 - ▷ "Show current position" places your current position at the center of the map.
 - ▷ "Show destination position" places the current destination at the center of the map.
 - ▷ "Return to map" changes back to the "Input map".
 - ▷ ↵ Exit the menu.

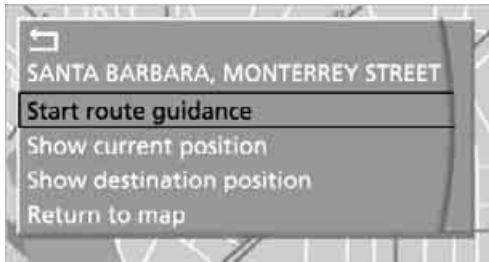

7. Press the controller.

The map for destination entry can also be called up in the map display:
Select the  symbol and press the controller.

Selecting destination using information

You can have a list of selected destinations displayed, e.g. hotels, sights or hospitals, and transfer them for destination guidance.

1. Select "Information" and press the controller.



2. Selecting location:
 - ▷ "On destination"
 - ▷ "On location"
 - ▷ "On a new destination"

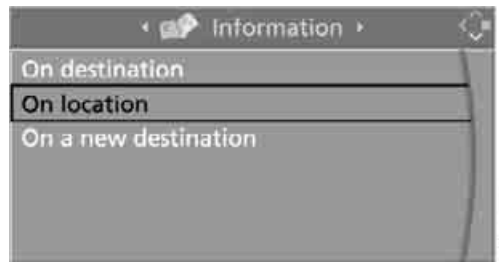

3. Press the controller.
4. Make your selection, e.g. "Hotels and restaurants", and press the controller. Destinations are shown on the Control Display.



5. Select a destination and press the controller.
6. Select a menu item:
 - ▷ To transfer the address to the destination list and start destination guidance:

Select "Select as destination" and press the controller.

- ▷ To establish a telephone connection: Select "Call" and press the controller.

To exit from the menu:

Select the  arrow and press the controller.

Destination list

The last 20 destinations entered into the system are shown in the destination list. You can call up these destinations and transfer them for destination guidance.

If you are planning a longer journey, for example, you can store all the destinations you wish to drive to in the destination list in advance, refer to Entering a destination manually on page 131.

Select "Navigation" and press the controller.



The destination last entered is listed first in the destination list.

 This symbol identifies the current destination during destination guidance.

To show other destinations in the destination list:

Turn the controller.

Transferring destination for destination guidance

1. Select the desired destination from the destination list and press the controller.
2. Select "Start guidance" and press the controller.

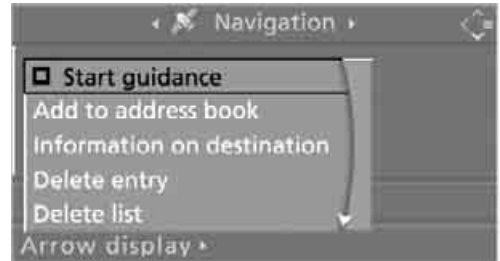

Editing the destination list

1. Select the desired destination from the destination list and press the controller.
2. The selected destination can be edited:
 - ▷ To store the entry: Select "Add to address book".
 - ▷ To display information on the destination: Select "Information on destination".
 - ▷ To delete the entry: Select "Delete entry".
 - ▷ To delete all entries: Select "Delete list". The destination guidance is switched off.
 - ▷ To change an entry: Select "Edit". For operation, refer to Entering destination by town/city name, page 132.
3. Press the controller.

Address book

Opening address book

iDrive, for operating principle refer to page 16.

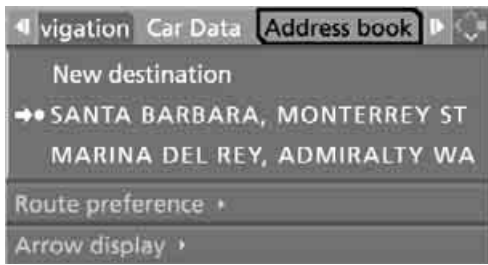

Select "Address book" and press the controller.

Storing destinations in address book

You can store approx. 100 destinations in the address book.

1. Select "Address book" and press the controller.
2. Select "New address" and press the controller.

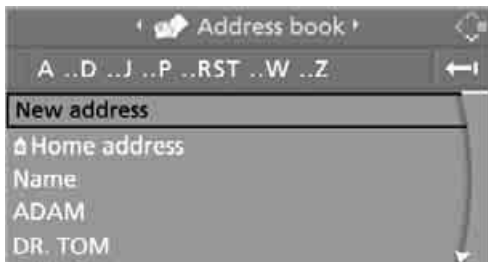

3. Select "Enter address" and press the controller.
4. Enter name and address.
5. Select "Store in address book" and press the controller.

The entry is stored in the address book.

You can also store a destination from the destination list in the address book, refer to page 138.

Storing current position*

The current position can be transferred to the address book.

1. Select "Address book" and press the controller.
2. Move the highlight marker to the third field from the top. Turn the controller until "New

address" is selected and press the controller.

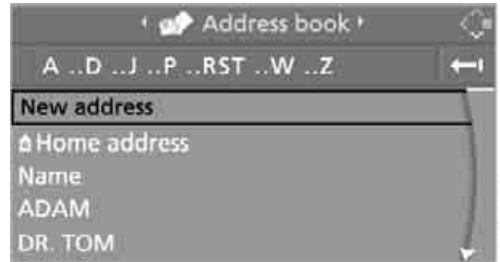

3. Select "Use current location as address" and press the controller.
The name given can be changed. For operation, refer to Entering a destination manually, page 131.
4. Select "Store in address book" and press the controller.

You can also enter your current position into the address book if you have left the area covered by the navigation DVD. In this case, you must enter a name.

Selecting destinations from address book

1. Select "Address book" and press the controller.
The stored entries appear on the Control Display.



2. Select the entry and press the controller.

To start destination guidance: Select "Start guidance" and press the controller.



3. Select "Delete address" and press the controller.

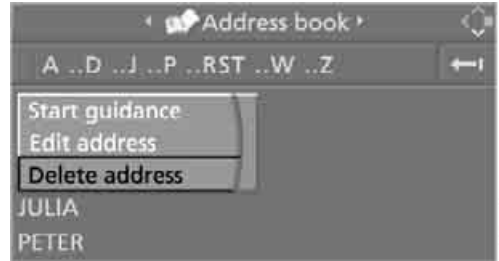

Changing destinations from address book

1. Select "Address book" and press the controller.
2. Select the entry and press the controller.
3. Select "Edit address" and press the controller.



4. Change entry.
For operation, refer to Entering a destination manually, page 131.
5. Select "Store in address book" and press the controller.

Deleting individual destinations from address book

1. Select "Address book" and press the controller.
2. Select the entry and press the controller.

Deleting all destinations from address book

1. Open the start menu.
2. Press the controller to open the **i** menu.
3. Select "Settings" and press the controller.
4. Select "Vehicle and tires" and press the controller.
5. Select "Delete data" and press the controller.



6. Select "Delete address book" and press the controller.
7. Select "Yes" and press the controller.

Home address

You can store your current position or the current destination as the home address in the address book. This entry occupies the second position in the address book.

Storing home address

1. Select "Address book" and press the controller.
2. Move the highlight marker to the third field from the top. Turn the controller until

"Home address" is selected and press the controller.

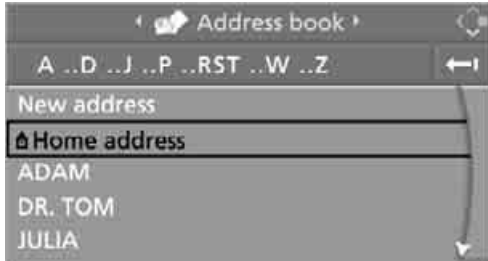

3. Select "Use current location as address" or "Save current destination" during the destination guidance and press the controller.
4. With the Professional navigation system: Select "Store in address book" and press the controller.

Using home address as destination

1. Select "Home address" and press the controller.
2. Select "Start guidance" and press the controller.

Changing home address

1. Select "Home address" and press the controller.
2. Select "Edit address" and press the controller. For operation, refer to Entering a destination manually, page 131.

Route selection

You can influence the calculated route by choosing certain route criteria. You can change the route criteria as often as you like during destination entry or during destination guidance.

The route is planned according to fixed rules. The type of road is taken into account, e.g. whether it is a highway or a winding road. The road types are stored on the navigation DVD. As a result, the routes recommended by the navigation system may not always be the same ones that you would choose based on personal experience.

Changing route criteria

1. Select "Navigation" and press the controller.
2. Move the highlight marker to the third field from the top. Turn the controller until "Route preference" is selected and press the controller.



The various criteria are shown on the Control Display.

3. Select a route criterion for the route:
 - ▷ "With highways"
Highways and major traffic arteries are given priority.
 - ▷ "Avoid highways"
Highways are avoided as far as possible.
 - ▷ "Fast route"
The fast route, being a combination of the shortest possible route and the fastest roads
 - ▷ "Short route"
Short route, irrespective of how fast or slow progress will be
4. Press the controller.



 The route criterion is highlighted.

5. If necessary, select an additional route criterion and then press the controller:
 - ▷ "Dynamic route"
Automatic rerouting due to traffic obstructions. Depending on the type of road as well as the type and length of traffic obstruction, the route can also be calculated in a way that passes through the traffic obstruction.
 - ▷ "Avoid tollroads"
Toll roads are avoided as far as possible.
 - ▷ "Avoid ferries"
Ferries are avoided as far as possible.

To exit from the menu:

Select the  arrow and press the controller.

The route criteria can also be changed in the arrow or map display.

1. Select the symbol for the route criterion and press the controller.
2. Select a route criterion and press the controller.

Word-matching principle

The system's word-matching principle makes it easier for you to enter the names of streets or towns. The system runs ongoing checks, comparing your destination entries with the data stored on the navigation DVD as the basis for instant response. The benefits for you include:

- ▷ Names of specific locations can also vary from the official versions if you are using a spelling that is customary in another country.

Example:

Instead of the German spelling "München" you can also enter the English spelling "Munich" or the Italian spelling "Monaco".

- ▷ When you are entering the names of towns and streets the system will complete them automatically as soon as enough letters are available to ensure unambiguous identification.
- ▷ The system only accepts name entries beginning with letters that are stored on the

navigation DVD. The system will not accept non-existent names and addresses.

Destination guidance

Starting destination guidance

iDrive, for operating principle refer to page 16.

1. If necessary, move the highlight marker to the uppermost field. Turn the controller until "Navigation" is selected and press the controller.
2. Select the destination from the destination list and press the controller or enter a new destination, refer to page 131.

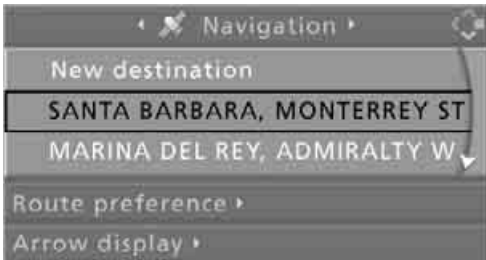

3. Select "Start guidance" and press the controller.



After the route has been calculated, destination guidance is indicated by arrows or a map on the Control Display.

The destination guidance can also be started in the arrow or map display:

Select the  symbol and press the controller.

During destination guidance, you can operate other equipment items at any time via iDrive. You will be notified in time of any necessary change of direction by means of spoken

instructions and the display of the direction arrow.

Terminating/continuing destination guidance

In the arrow or map display

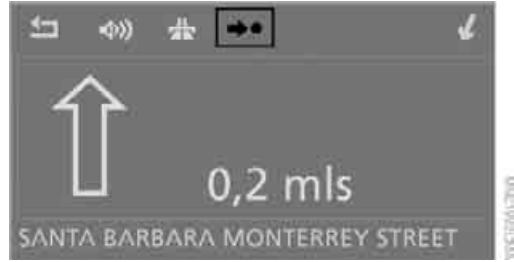

Select the  symbol and press the controller.

In the destination list

 This symbol indicates the current destination.

1. Select the current destination and press the controller.



2. Select "Start guidance" and press the controller.

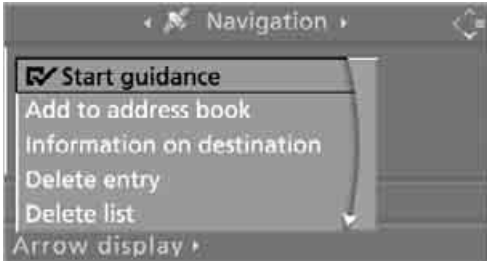

- "Arrow display" is selected and press the controller.



If you did not reach the destination before the end of the last journey, the following question will appear in the display at the start of the next journey:

"Continue guidance to destination?".

The destination guidance starts automatically after a short time.

To start destination guidance immediately: Select "Yes" and press the controller.

The arrow display is shown.



Route display

You have the option of displaying various views of the route during destination guidance.

 From another menu, you can switch directly to the screen last displayed, refer to Convenient call-up of menu items on page 18. ◀

Displaying arrow view

1. Select "Navigation" and press the controller.
2. Move the highlight marker to the fourth field from the top. Turn the controller until

- 1 Switching voice instructions on/off
- 2 Selecting route criteria
- 3 Starting/stopping destination guidance
- 4 Arrow to destination as the crow flies
- 5 Distance to the next change of direction
- 6 Current location
- 7 Direction of travel
 - ▷ Outline of an arrow: Destination guidance on the calculated route
 - ▷ Solid arrow: Arrow points as the crow flies to the calculated route whenever the vehicle is not in an area recorded on the navigation DVD, e.g. in a parking garage.

Depending on your vehicle's equipment, the projected time of arrival and distance to the destination is displayed in the top or bottom line of the Control Display.

The arrows change appearance before a change of direction.



- 1 Street name for change of direction
- 2 Distance to change of direction
- 3 Change of direction

To exit from the menu:
Select the  arrow and press the controller.

Displaying maps



You can have your current position displayed on a map. After starting the destination guidance, the planned route is shown on the map.

1. Select "Navigation" and press the controller.
2. Move the highlight marker to the fourth field from the top. Turn the controller until the desired map view is selected:
 - ▷ "Map facing north"
 - ▷ "Map direction of travel"
 - ▷ "Perspective"



3. Press the controller.



- 1 Switching voice instructions on/off
- 2 Starting/stopping destination guidance
- 3 Map-guided destination selection
- 4 Showing/hiding information last selected, refer to Selecting destination using information on page 137
- 5 Changing map view
 - ▷  "Map facing north"
 - ▷  "Map direction of travel"
 - ▷  "Perspective"
- 6 Changing route criteria
- 7 Calling up traffic information* manually
- 8 Arrow to destination as the crow flies

The projected time of arrival and distance to the destination is displayed in the bottom line of the Control Display.

To exit from the menu:
Select the  arrow and press the controller.

At scales of less than 250 miles/500 km, you have the option of deciding whether to orient the map to north, toward your current direction of travel, or show the map in perspective. At scales of 250 miles/500 km or greater, the map always points toward north.

Changing map view



Select the corresponding symbol and press the controller.

The next map view is displayed.

To change scale

Turn the controller to adjust the scale.

Displaying towns/cities and streets along the route

You can have the roads and towns along the route displayed during destination guidance.

The distances remaining to be traveled within each section of the route are also displayed.

1. Select "Navigation" and press the controller.
2. Move the highlight marker to the third field from the top. Turn the controller until "Route list" is selected and press the controller.

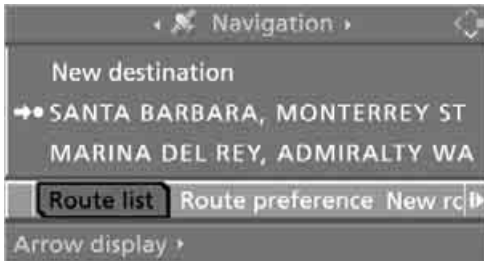

To exit from the menu:
Select the  arrow and press the controller.

Destination guidance through voice instructions

Switching voice instructions on/off

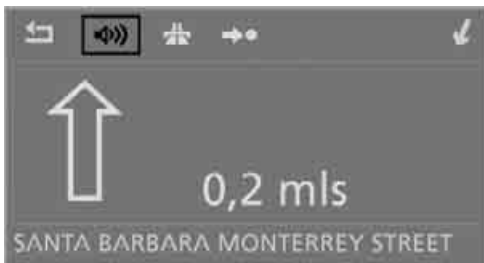

Voice instructions can be switched on or off during the destination guidance in the arrow or map view:

Select the  symbol and press the controller.

To switch the voice instructions on/off at any time:

1. Open the start menu.
2. Press the controller to open the **i** menu.
3. Select "Settings" and press the controller.



4. Select "Language / Units" and press the controller.
5. If necessary, move the highlight marker to the uppermost field. Turn the controller until "Languages" is selected and press the controller.

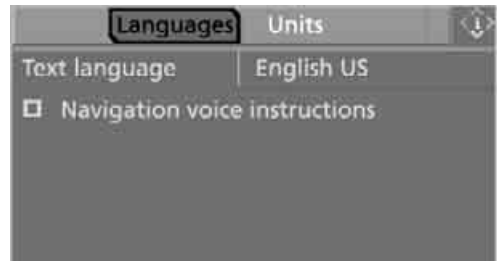

6. Select "Navigation voice instructions" and press the controller.

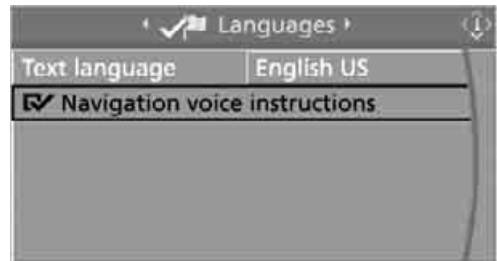

 The voice instructions are switched on.

Repeat voice instructions and cancel

With the programmable buttons on the steering wheel, you can also execute the following functions, refer to page 51:

- ▷ Repeat the voice instruction:
Press the button.
- ▷ Switch voice instructions on/off:
Press the button for a longer period.

Adjusting volume of voice instructions

The volume can be adjusted only while a voice instruction is being issued.

1. Have the last voice instruction repeated, if necessary.
2. Turn the button during the voice instruction to select the desired volume.

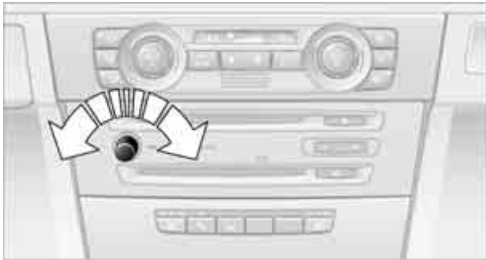

This volume is independent of the volume of the audio sources.

The setting is stored for the remote control currently in use.

Changing a route

During destination guidance, you can revise the navigation system's route recommendations to avoid particular stretches of road. Enter the number of miles/kilometers that you want to travel before returning to the original route.

1. Select "Navigation" and press the controller.
2. Move the highlight marker to the third field from the top. Turn the controller until "New route" is selected and press the controller.



3. Turn the controller to enter the desired number and press the controller.

The route is recalculated.

To exit from the menu without changing the route:

Select the  arrow and press the controller.

Traffic information*

In covered metropolitan areas, you can have traffic information from participating radio stations that transmit traffic info data. This information is continually updated with the help of measurement data from traffic control centers and messages from traffic observers.

During navigation guidance, the traffic information relevant to the route you are currently taking is automatically shown. Irrespective of whether destination guidance is active, you can have the traffic information displayed in the map view or as an event list.

Switching reception of traffic information on/off

iDrive, for operating principle refer to page 16.

1. Press the **MENU** button.
This opens the start menu.
2. Press the controller to open the **i** menu.

- Turn the controller until "Settings" is selected and press the controller.





- Turn the controller until "Traffic Info" is selected and press the controller.

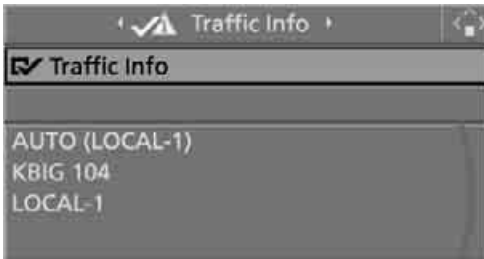

- Select "Traffic Info" and press the controller.
"AUTO": automatic selection of the Traffic Info station with the strongest received signal.

 Depending on the station, either the station name, frequency, local number or other information is displayed.





 The traffic information can be transmitted and displayed.

Displaying traffic information manually

With destination guidance active

Traffic information can be displayed manually during destination guidance in the arrow and map view:

 If the symbol is shown with a red border, there is traffic information on the planned route. Select the  symbol and press the controller.



During destination guidance, the traffic information on the planned route is marked by a yellow diamond symbol.

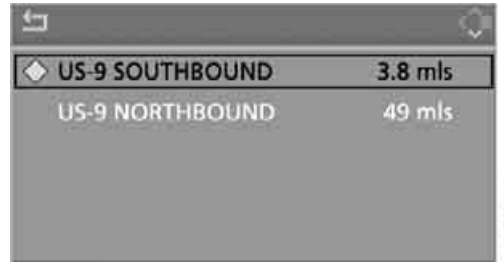

With destination guidance not active

- Open the start menu.
- Move the controller to the right to call up "Navigation".

3. Select "Traffic Info" and press the controller.

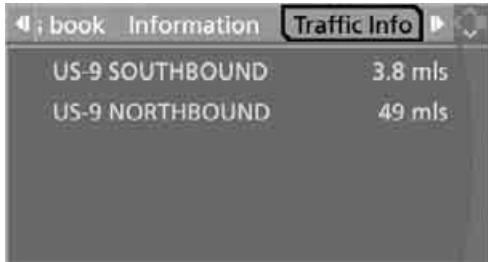

Current traffic information is shown on the Control Display, sorted by distance from the vehicle's current position.

Displaying detailed traffic information



Select a traffic information item from the list and press the controller.



To exit from the menu:
Select the  arrow and press the controller.





Displaying traffic information in map view

The traffic information symbols are shown in map view up to a scale of 100 miles/200 km.

-  Traffic displayed with map scales larger than 5 miles/10 km; arrow points in relevant direction of travel.
-  There are several traffic events within the area. Switch to a smaller map scale to show more detail.

With a scale up to 5 miles/10 km, additional information is shown. The length, direction and

severity of a traffic obstruction are indicated by means of arrows along the route, for example:

-  Slow-moving traffic
-  Stop-and-go traffic
-  Stopped traffic
-  Stopped traffic in both directions of travel

On the planned route

Traffic information icon is displayed on yellow

Outside of the planned route

- ▷ Map scale up to 5 miles/10 km:
Traffic information is displayed on white with a black or gray border.
- ▷ Map scale larger than 10 miles/20 km:
An arrow pointing in the relevant direction of travel is displayed on white with a black or gray border.

Dynamic destination guidance

Depending on whether "Dynamic route" is selected, the system responds differently:

- ▷ "Dynamic route" not selected:
When the navigation system receives a traffic obstruction message, you receive certain information, such as the extent of the traffic congestion, when you are approx. 25 miles/40 km away from the obstruction. The last possible detour exit is indicated just before you reach it.
- ▷ "Dynamic route" selected:
In case of a traffic obstruction the guided route is adapted automatically. Depending on road type and the kind and extent of the traffic obstruction, the guided route may lead through the obstruction. This information is displayed even if you have called up another application on the Control Display.

Driving around a traffic congestion



Select "Detour" and press the controller. The navigation system calculates a new route to avoid the traffic incident.

Traffic information icons

- Traffic light failure
- Roadworks
- General traffic obstruction
- Transport of hazardous load
- Danger
- Low clearance
- No parking
- Fog
- Heavy rain
- Slippery road
- Cross winds
- Smog
- Road closed
- Slow traffic
- Traffic backup
- Stopped traffic

- Icy roads
- Uneven surface
- Accident
- Lane closure
- Delay
- Police checkpoint

Displaying current position

You can have your current position displayed even when the destination guidance is switched off.

1. Select "Navigation" and press the controller.
2. Move the highlight marker to the fourth field from the top. Turn the controller until "Current position" is selected and press the controller.

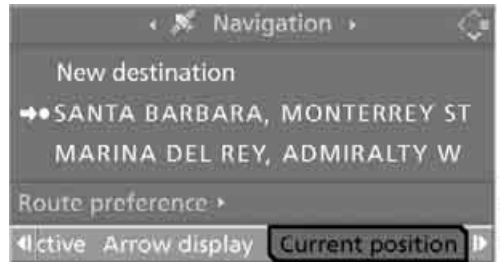

The current position of your BMW is displayed.

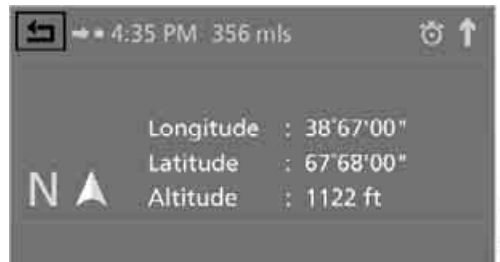

If the navigation system is unable to identify a town or city, your current map coordinates will appear.

To exit from the menu:

Select the  arrow and press the controller.

You can also have the current position displayed on a map, refer to page [145](#).

What to do if ...

What to do if ...

- ▷ a navigation DVD is inserted, but an instruction to insert the DVD appears on the Control Display?

The navigation DVD may not be the correct DVD for the navigation system. This information is indicated on the DVD label.

- ▷ you request the current position of your vehicle, but do not receive a precise display?

The system is unable to receive enough GPS signals at your current position due to obstructions, your current position is not yet available on your navigation DVD, or the system is in the process of calculating your current position. As a rule, reception is guaranteed when you are in the open.

- ▷ the destination guidance does not accept a destination?

The data of the destination is not stored on the navigation DVD that is loaded. Choose a destination as close as possible to the original one.

- ▷ the destination guidance does not accept an address without the street name?

On the navigation DVD, no downtown area can be determined for the city or town entered. Enter any street, or a destination such as the railway station in the selected town, and then start the destination guidance.

- ▷ you want to enter a destination for the destination guidance, but it is not possible to select the letters for your desired entry?

The data of the destination is not stored on the navigation DVD that is loaded. In this case, the system will not offer you any letters to choose from. Choose a destination as close as possible to the original one.

- ▷ the system stops furnishing directions on which way to turn as you approach intersections?

You are driving in an area that has not yet been completely recorded on the naviga-

tion DVD. Instead of an arrow indicating a turn, you will see an arrow which indicates the general direction of your planned route. Or you have left the recommended route and the system requires a few seconds to calculate a new recommended route.

- ▷ the navigation system does not react to entries?

If the battery was disconnected, it takes about 10 minutes before the system is once again operational.





Entertainment

Operation of the radio and CD equipment as well as their tone settings are described in this chapter.

On/off and settings

The following audio sources have shared controls and setting options:

- ▷ Radio
- ▷ CD player
- ▷ CD changer*

Controls

The audio sources can be operated using:

- ▷ Buttons near the CD player
- ▷ iDrive
- ▷ Buttons on the steering wheel, refer to page 11

Buttons on the CD player

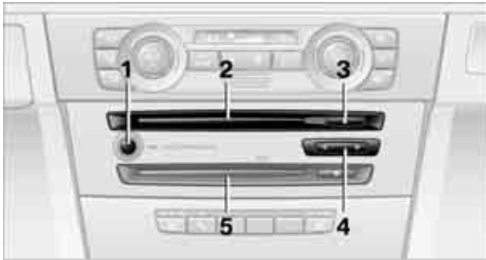

- 1 Sound output for entertainment on/off, volume
 - ▷ Press: switch on/off.
When you switch on, the last set radio station or CD track is played.
 - ▷ Turn: adjust volume.
- 2 Drive for audio CDs
- 3 Eject CD
- 4 Station scan/track search
 - ▷ Change radio station.
 - ▷ Select track for CD player and CD changer.
- 5 Drive for navigation DVD

Operation via iDrive

iDrive, for operating principle refer to page 16.

1. Press the **MENU** button.
This opens the start menu.
2. Move the controller backwards to call up "Entertainment".



You have the following choices:

- ▷ "FM" and "AM": radio reception
- ▷ "WB": Weather Band station
- ▷ "SAT": satellite radio
- ▷ "CD": CD player or changer
- ▷ "AUX": external audio device
- ▷ "Set": depending on the audio source, other adjustments can be made, e.g. with the radio: update station with strongest reception, store station, tone control, sample stations.

From another menu, you can switch directly to the screen last displayed, refer to Convenient call-up of menu items on page 18. ◀

With the ignition key in radio-ready position or higher, the selected audio source is stored for the remote control currently in use.

Switching on/off

In order to switch the entertainment sound output on and off:

Press button **1** on the CD player.

This symbol on the Control Display indicates that sound output is switched off.

Adjusting volume

Turn knob **1** on the CD player until the desired volume is obtained.

You can also adjust the volume with buttons on the steering wheel, refer to page **11**.

With the ignition key in radio-ready position or higher, the setting is stored for the remote control currently in use.

Tone control

You can alter various tone settings, e.g. treble and bass or the speed-dependent volume increase.

The tone settings are applied to all audio sources.

With the ignition key in radio-ready position or higher, the settings are stored for the remote control currently in use.

Changing tone settings

1. Press the **MENU** button.
This opens the start menu.
2. Press the controller to open the **i** menu.
3. Turn the controller until "Settings" is selected and press the controller.
4. Select "Audio" and press the controller.



The tone settings can also be selected if you have called up "Entertainment" in the start menu:

Select "Set" and then "Tone", and press the controller.

Treble and bass

1. Select "Treble / Bass" and press the controller.



2. Move the controller to the left or right to select "Treble" or "Bass".



3. Turn the controller until the desired setting is selected.

Balance and fader

You can adjust the volume distribution in the same manner as "Treble / Bass".

- ▷ "Balance": left/right volume distribution
- ▷ "Fader": front/rear volume distribution

Speed-dependent volume control

The speed-dependent volume control automatically increases the volume with increasing driving speed. You can set various stages for the increase in volume.

1. Select "Speed volume" and press the controller.

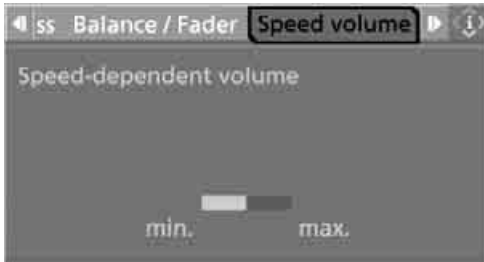

2. Turn the controller:
The adjustment is applied; the field can be changed.



Professional LOGIC7 HiFi System*

You can select a spatial sound effect that improves the spatial acoustics in all frequency ranges.

1. Select "Surround Settings" and press the controller.



2. Select "Concert hall" or "Theater".



3. Press the controller.
LOGIC7 spatial sound is switched on.

To switch off the spatial sound effect:
Select "Off" and press the controller.

LOGIC7 and the LOGIC7 logo are registered trade marks of Lexicon, Inc., a company of the Harman International Group.

Equalizer

You can set individual sound frequency ranges.

1. Select "Equalizer" and press the controller.



2. Move the controller to the left or right to select the desired frequency range.

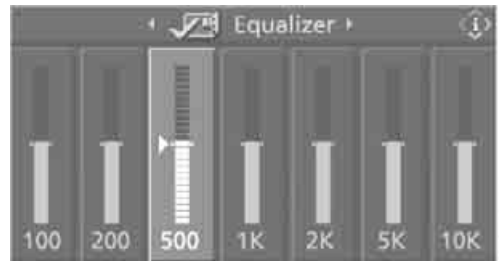

3. Turn the controller until the desired setting is selected.

Resetting tone settings

You can reset all tone settings to the default setting.

1. Open the start menu.
2. Press the controller to open the **i** menu.
3. Turn the controller until "Settings" is selected and press the controller.
4. Select "Audio" and press the controller.
5. If necessary, move the highlight marker to the uppermost field. Turn the controller until "Reset" is selected and press the controller.



6. In vehicles equipped with two drives: Select "Yes" and press the controller.

Radio

Your radio provides reception of the FM and AM wavebands:

Listening to the radio



Press the button if the sound output is switched off.

iDrive, for operating principle refer to page 16.

1. Press the **MENU** button.
This opens the start menu.
2. Move the controller backwards to call up "Entertainment".
3. If necessary, move the highlight marker to the uppermost field. Select "FM" or "AM".



4. Press the controller.

Stations are shown on the Control Display on the basis of various selection criteria, e.g. "Presets".

If "Autostore" does not show a station in the AM waveband or if the displayed stations are no longer receivable, update the stations with the strongest received signal, refer to page 161.

Changing stations



Turn the controller.

Buttons on the CD player

Press the button for the corresponding direction.

The system switches to the next displayed station.

You can also change the station with buttons on the steering wheel, refer to page 11.

Changing selection criteria

In addition to the stations currently displayed, you can have stations with another selection criterion displayed.

You can choose from the following selection criteria:

- ▷ "All stations":
Stations that can currently be received on the "FM" waveband.
- ▷ "Autostore":
The stations with the strongest received signals in the "AM" waveband.
- ▷ "Presets":
Stations you have previously stored, refer to page 162.

To change the selection criterion:

1. Move the highlight marker to the second field from the top.
2. Choose a selection criterion and press the controller.



Sampling stations, scan

The stations on the current waveband are automatically sampled in succession.

1. Select "FM" or "AM" and press the controller. "Set" is selected.
2. Press the controller. Other menu items are displayed.
3. Select "Scan" and press the controller.





The stations are sampled.

Stop sampling:

1. Press the controller.
2. Select "Scan" and press the controller.

Station sampling is interrupted and the selected station stays on.

Buttons on the CD player

  To sample stations, press the button for the corresponding direction for an extended time.

To stop scanning, press the button again.

Selecting the frequency manually

With "Manual" you can select stations that are received in addition to those displayed.

1. Select "FM" or "AM" and press the controller.
2. Move the highlight marker to the second field from the top.
3. Select "Manual" and press the controller.



4. Turn the controller to set a certain frequency.

Updating stations with best reception

If on a longer journey you move out of the reception range of the stations originally received, you can update the list of stations received with the strongest signals in the AM waveband.

1. Select "AM" and press the controller.
2. Move the highlight marker to the second field from the top.
3. Select "Autostore" and press the controller. "Set" is selected.



4. Press the controller. Other menu items are displayed.

5. Select "Autostore" and press the controller.



The display of the stations with the strongest reception is updated. The frequencies of the stations are displayed.

Storing stations

1. Select "FM" or "AM" and press the controller.
2. Move the highlight marker to the second field from the top. Turn the controller until the desired selection criterion is chosen and press the controller.
3. Select the desired frequency or station. "Set" is selected.



4. Press the controller. Other menu items are displayed.

5. Select "Store" and press the controller.

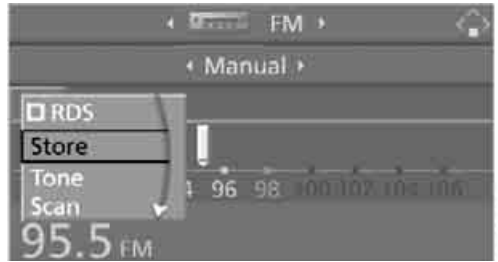

"Presets" is displayed.

6. Turn the controller until the desired memory position is selected.
7. Press the controller. The station is stored.



The channels of the last selection criterion are displayed once again after a short time.

With the ignition key in radio-ready position or higher, the stations are stored for the remote control currently in use.

Changing a memory position

1. Select "Presets" and press the controller.
2. Select the desired station. "Set" is selected.
3. Press the controller. Other menu items are displayed.

4. Select "Store" and press the controller.



5. Turn the controller until the desired memory position is selected. The number of the memory position appears beside the name or frequency of the station.
6. Press the controller. The station is stored.

RDS Radio Data System

RDS transmits additional information in the FM frequency range. If the reception conditions are good, the station names are shown on the Control Display. Where reception is poor or in the event of interference, it may take some time before the station names will appear in the display.

Switching RDS on/off*

1. Select "FM" and press the controller. "Set" is selected.
2. Press the controller. Other menu items are displayed.
3. Select "RDS" and press the controller.



RDS is activated.

Satellite radio*

You can receive over 100 different channels with high sound quality.

The channels are offered to you in predefined packages. To receive the channels of your choice, you must have this package enabled.

 With this new technology, signal losses can occur from time to time and result in audio interruptions. ◀

Enabling or disabling channels

iDrive, for operating principle refer to page 16.

1. Press the **MENU** button. This opens the start menu.
2. Move the controller backwards to call up "Entertainment".
3. Select "SAT".



4. Press the controller.

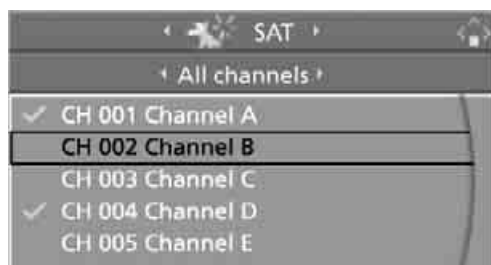

The channels are displayed.
 These channels are enabled.

Enabling

1. Select a channel that has not yet been enabled and press the controller.

A telephone number and the electronic serial number, ESN, are displayed.

 The electronic serial number is required to enable or disable. ◀

- To enable the channel:
Dial the phone number.

Disabling

- Select an enabled channel and press the controller.

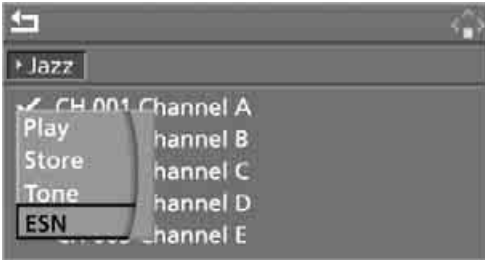

- Select "ESN" and press the controller. The electronic serial number, ESN, is displayed.

 The electronic serial number is required to disable. ◀

- To disable the channel:
Dial the phone number.

Selecting and storing a channel

- Select "SAT" and press the controller.



Channels are shown on the Control Display sorted on the basis of selection criteria.

- Select a menu item:
 - ▷ "Presets":
Up to twelve channels you have stored previously.
 - ▷ "All channels":
All channels are displayed.
 - ▷ "Categories":
All channels, sorted by categories, e.g. news, jazz.



- Press the controller.
- If "Categories" has been selected:
Select the desired category and press the controller.

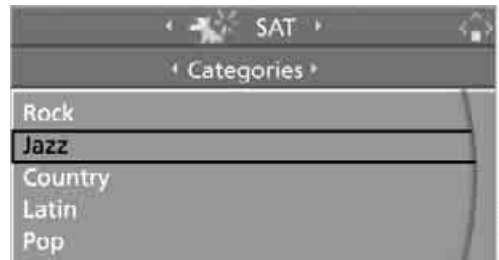

The channels of this category are displayed.

- ✓ Select a channel marked with this symbol.

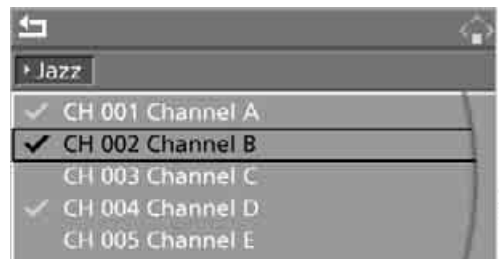

- Press the controller. Other menu items are displayed.
- Select "Play" and press the controller.

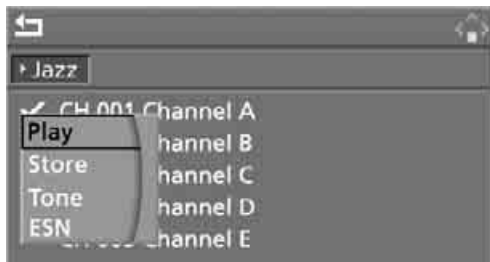

Additional information

The name of the channel and additional information on the current track are displayed, e.g. the name of the artist.

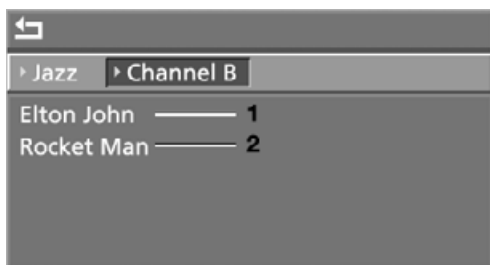

- Artist
- Track

Storing a channel

- Select the desired channel.
- Press the controller. Other menu items are displayed.
- Select "Store" and press the controller.

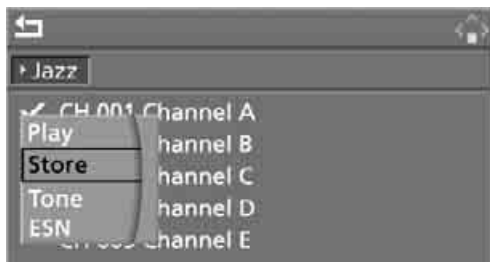

"Presets" is displayed.

- Turn the controller to select a memory location and press the controller.

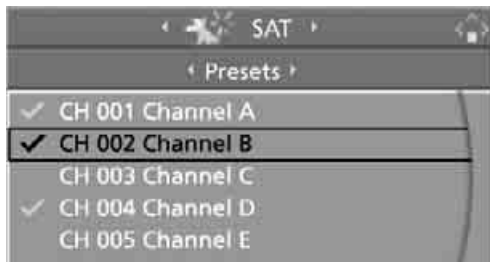

The channel is stored. The channels of the last selection criterion are displayed once again after a short time.

Changing channels with buttons on CD player

Press the button for the corresponding direction.

The system switches to the next enabled channel.

Notes

If no signal can be received for more than four seconds, a message will appear on the Control Display.

Under some circumstances, e.g. depending on environmental influences or topographic conditions, it may not be possible to receive any signal. The satellite radio cannot influence this.

A signal may not be available in tunnels or underground garages, next to high-rise buildings, in the vicinity of trees, mountains or other strong sources of radio interference.

Reception usually resumes as soon as the signal becomes available again. ◀

CD player and CD changer*

Listening to CDs



Compressed audio files*

CDs with compressed audio files, MP3s, can be played by the CD player and CD changer.

Starting the CD player

The upper drive is for audio CDs.

Insert the CD into the drive with the labeled side up.

The CD is pulled in automatically. Playback starts automatically if the sound output is on. When playing CDs with compressed audio files, it can take the CD player approx. 1 minute to read in the data, depending on the directory structure.

To start playback when there is already a CD in the drive:

iDrive, for operating principle refer to page 16.

1. Press the **MENU** button.
This opens the start menu.
2. Move the controller backwards to call up "Entertainment".

3. If necessary, move the highlight marker to the uppermost field. Select "CD" and press the controller.



4. If necessary, move the highlight marker to the second field from the top. On cars with a CD changer, select "CD" and press the controller to start the CD player.



Playback starts automatically if the sound output is switched on.

Starting the CD changer

1. Fill and insert the CD magazine, refer to page 170.
2. Press the **MENU** button.
This opens the start menu.
3. Move the controller backwards to call up "Entertainment".
4. If necessary, move the highlight marker to the uppermost field. Select "CD" and press the controller.

- If necessary, move the highlight marker to the second field from the top. Select the desired CD and press the controller.

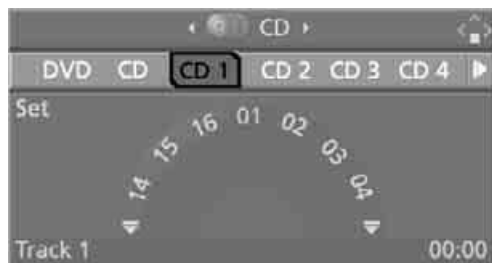

At the end of the last track, the next CD is selected and played.

If new CDs have been placed in the CD magazine, playback starts with the lowest CD, e.g. CD 1, track 1.

The CD magazine's load status is indicated on the Control Display.

Selecting a track

Buttons on the CD player

Press the button for the appropriate direction as often as necessary until the desired track is reached.

The track is displayed on the Control Display.

You can also change the track with buttons on the steering wheel, refer to page 11.

Via iDrive



Turn the controller to select a track.

Compressed audio files*

- Select a directory, if necessary, and press the controller.
- Select a track and press the controller.

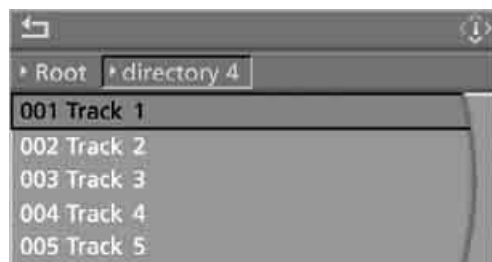
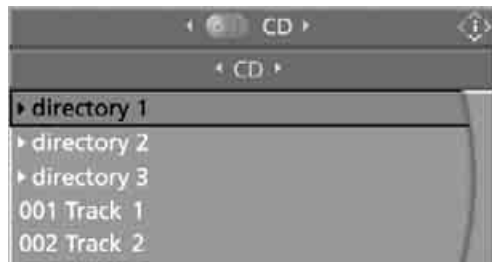

- Select "Play" and press the controller.

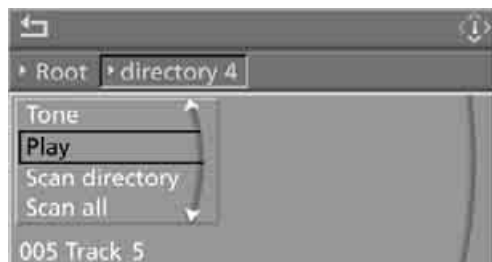

To change the directory:
Select the directory and press the controller.

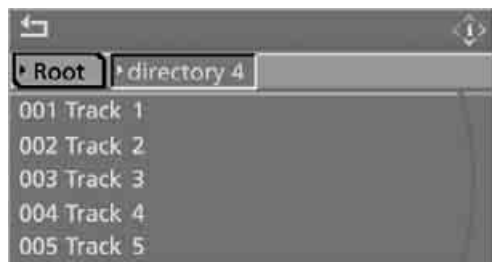

To exit from the menu:
Select the  arrow and press the controller.

Displaying information about the track*

With compressed audio files, any information about the current track that has been recorded can be displayed, e.g. the name of the artist.

1. Press the controller.
2. Select "Details" and press the controller.

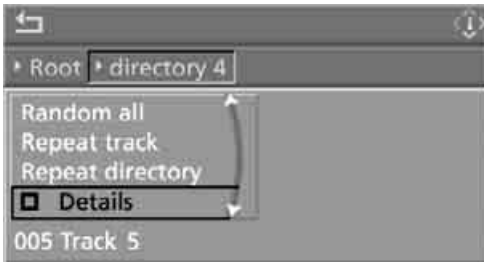

The information is shown for the current track.
The setting is stored for the remote control currently in use.

Sampling tracks, Scan

All tracks on the current CD are automatically sampled once in succession.

1. Select "Set" and press the controller.
Other menu items are displayed.



2. Select "Scan" and press the controller.

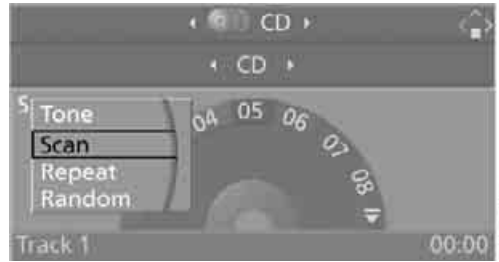

Stop sampling:

1. Press the controller.
2. Select "Scan" and press the controller.

Track sampling is interrupted and the selected track is played on.

Compressed audio files*

1. Select the current track and press the controller.
2. Select the desired menu item:
 - ▶ To sample all the tracks in the current directory, select "Scan directory" and press the controller.
 - ▶ To sample all the tracks on the CD, select "Scan all" and press the controller.

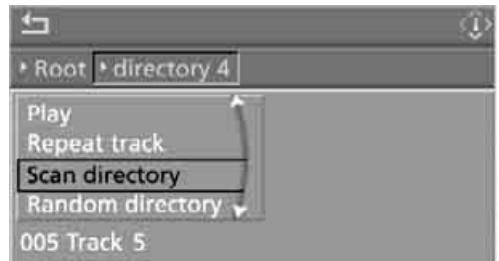

Stop sampling:

1. Press the controller.
2. Select "Scan directory" or "Scan all" and press the controller.

Sampling is interrupted and the selected track is retained.

Repeating tracks

1. Select "Set" and press the controller. Other menu items are displayed.



2. Select "Repeat" and press the controller.

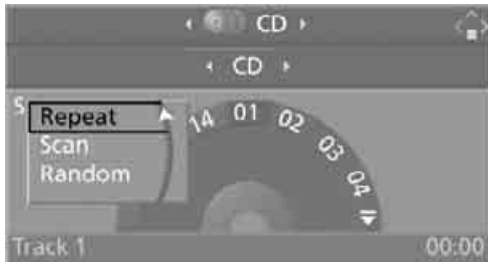

The current track on the CD is repeated.

Stop repeating:

1. Press the controller again.
2. Select "Repeat" and press the controller.

Compressed audio files*

1. Select the current track and press the controller.
2. Select the desired menu item:
 - ▶ To repeat the selected track, select "Repeat track" and press the controller.
 - ▶ To repeat all the tracks in the current directory, select "Repeat directory" and press the controller.

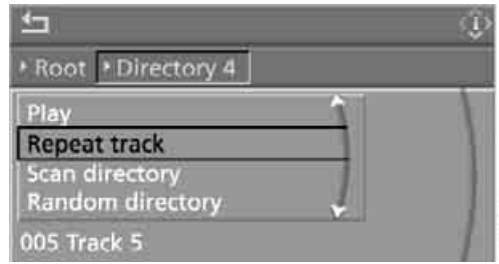

Stop repeating:

1. Press the controller.
2. Select "Repeat track" or "Repeat directory" and press the controller.

Random play sequence

The tracks on the current CD are played once each in random order.

1. Select "Set" and press the controller. Other menu items are displayed.
2. Select "Random" and press the controller.

Stop random function:

1. Press the controller.
2. Select "Random" and press the controller.

Compressed audio files*

1. Select the current track and press the controller.
2. Select the desired menu item:
 - ▷ To play all the tracks in the current directory in random order, select "Random directory" and press the controller.
 - ▷ To play all the tracks on the CD in random order, select "Random all" and press the controller.

Stop random function:

1. Press the controller
2. Select "Random directory" or "Random all" and press the controller.

Fast forward/reverse

Buttons on the CD player:

 Press and hold the button for the corresponding direction.

The tracks can be heard, but reproduction is distorted.

CD magazine

Sedan



Sports Wagon



The BMW CD changer for six CDs is behind the left side panel in the cargo bay.

Removing the CD magazine

To insert or remove CDs from the CD magazine, you must first remove it from the CD changer:

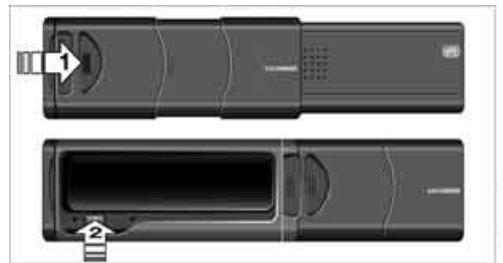

1. Push the cover to one side, arrow 1.
2. Press the button, arrow 2.
The CD magazine is ejected.

Inserting/removing CDs from the CD magazine



When loading CDs into or removing them from the CD magazine, hold them at their edges and do not touch the reflective signal-sensing area.

Inserting CDs:

Insert the CD in its slot with the label side on top.

Removing CDs:

Pull out the desired drawer, see arrow, and remove the CD.

Inserting the CD magazine

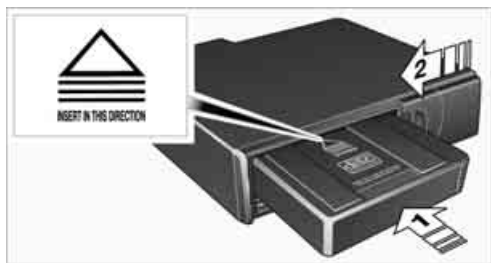

Insert the CD magazine all the way in the direction of arrow **1** and close the cover, arrow **2**.

The CD changer automatically reads in the loaded CDs and is then ready for operation.

Notes

 BMW CD/DVD players and changers are officially designated Class 1 laser products. Do not operate if the cover is damaged, otherwise severe eye damage can result. Do not use self-recorded CDs/DVDs with labels applied as these can become detached during playback due to heat build-up and can cause

irreparable damage to the device.

Only use round CDs/DVDs with a standard diameter of 12 cm and do not play CDs/DVDs with an adapter, e.g. Single-CDs, otherwise the CDs or the adapter can jam and will no longer eject.

Do not use a combined CD/DVD, e.g. DVD^{Plus}, otherwise the CD/DVD can jam and will no longer eject. ◀

General malfunctions

BMW CD/DVD changers and players have been optimized for performance in vehicles. In some instances they may be more sensitive to faulty CDs/DVDs than stationary devices would be.

If a CD/DVD cannot be played, first check if it has been inserted correctly.

Humidity

High levels of humidity can lead to condensation on the CD/DVD or the laser's scan lens and temporarily prevent playback.

Malfunctions with individual CDs/DVDs

If malfunctions only occur with individual CDs/DVDs, one of the following factors may be the cause.

Self-recorded CDs/DVDs

Possible reasons for malfunctions with self-recorded CDs/DVDs are, e.g., inconsistent data-creation or recording processes, or poor quality or high age of the CD/DVD blank.

Only label CDs/DVDs on the top, with a pen designed for this purpose.

Damaged CDs/DVDs

Avoid leaving fingerprints, as well as dust, scratches or moisture on the CDs/DVDs. Keep CDs/DVDs in protective sleeves or cases. Do not subject CDs/DVDs to temperatures over 120 °F / 50 °C, high levels of humidity or direct sunlight.

CDs/DVDs with copy protection

CDs/DVDs are often copy-protected by the manufacturer. This can mean that some CDs/

DVDs cannot be played or can only be played to a limited extent.

Care

Clean the reflective signal side of CDs/DVDs as needed by wiping it with a commercially available cleaning tissue in straight lines from the center of the disc outwards. For more information on taking care of CDs/DVDs please refer to the Caring for your vehicle brochure.

External audio device

You can connect an external audio device, for instance an MP3 player, and play audio tracks over the car's loudspeaker system. You can adjust the tone using iDrive.

Connecting

Lift up the center armrest.



- 1 Power supply for your external audio device:
Socket with removable cap
- 2 Connection for audio playback:
jack plug, 3.5 mm

To play audio tracks over the car's loudspeaker system, connect the headset or line-out port of the external device to connection **2**.

Starting audio playback

The audio device must be switched on.

iDrive, for operating principle refer to page [16](#).

1. Press the **MENU** button.
This opens the start menu.
2. Move the controller backwards to call up "Entertainment".

3. Select "AUX" and press the controller.

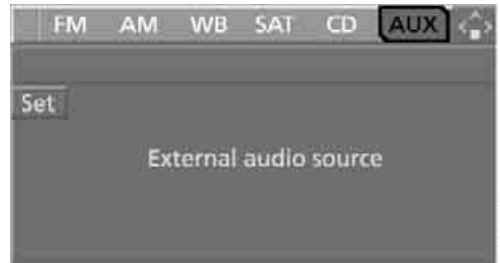

4. Adjust volume and tone, if necessary.



Communications

This chapter describes how to use the telephone, BMW Assist and TeleService.

Telephoning*

The concept

Your BMW is equipped with a full mobile phone preparation package. After pairing a suitable mobile phone with the vehicle once, you can operate the mobile phone via iDrive, the buttons on the steering wheel or via voice commands.

Once a mobile phone has been paired with your vehicle, it is automatically recognized as soon as it is inside the vehicle while the engine is running or the ignition is switched on. You can store the pairing data for up to four mobile phones simultaneously. If several mobile phones are detected at the same time, the mobile phone last paired can be operated via the vehicle.

Using the telephone inside the vehicle

Using the snap-in adapter*

The so-called snap-in adapter, a holder for mobile phones, allows you to charge the mobile phone's battery and connect the mobile phone to your vehicle's outside antenna. This ensures better network reception and consistent reproduction quality. Please contact your BMW center to find out for which mobile phones there are snap-in adapters available.



BMW discourages the use of mobile phones or other mobile communications devices inside the vehicle without a direct connection to an outside antenna. Otherwise, interference between vehicle electronics systems and the mobile communications device cannot be ruled out. In addition, there is no assurance that the radiation which results from transmission will be dissipated from the vehicle interior. ◀

Avoid operating a mobile phone recognized by the vehicle via the mobile phone's keypad, otherwise malfunctions may result.

For your safety

A car phone makes life more convenient in many ways, and can even save lives in an emergency. While you should consult your mobile phone's separate Owner's Manual for a detailed description of safety precautions and information, we request that you direct your particular attention to the following:



Only make entries when the traffic situation allows you to do so. Do not hold the mobile phone in your hand while you are driving; use the hands-free system instead. If you do not observe this precaution, your being distracted can endanger vehicle occupants and other road users. ◀

Suitable mobile phones

Please ask your BMW center which mobile phones with Bluetooth interface are supported by the mobile phone preparation package and/or which mobile phones are compatible with the snap-in adapter. By virtue of their particular software versions, these mobile phones support the functions described in this Owner's Manual. Malfunctions may occur with other mobile phones.

Care instructions

You can find what you need to know about caring for your mobile phone in the separate Caring for your vehicle brochure and in the mobile phone Owner's Manual.

Operating options

You can operate the mobile phone* using:

- ▷ The steering wheel, refer to page 10
- ▷ iDrive, refer to page 181
- ▷ Voice commands, refer to page 185

Making phone calls with the BMW Assist system*: BMW Assist calls

You can use the BMW Assist System via the hands-free unit for BMW Assist calls.

When the status information "BMW Assist" or "BMW Service" is displayed in "Communication", only BMW Assist calls are possible.

It may not be possible to establish a telephone connection using the mobile phone while a connection is being established to BMW Assist or while a call to BMW Assist is already in progress. If this happens, you must unpair the mobile phone and the vehicle if you wish to place a call with the mobile phone.

Start-up

Pairing the mobile phone with the vehicle

The following prerequisites must be met:

- ▷ The mobile phone is ready to operate
- ▷ The Bluetooth link in the vehicle, refer to page 180, and in the mobile phone are activated
- ▷ Depending on the mobile phone, some default settings may be necessary for the mobile phone: e.g. via the menu item Bluetooth switched on or the menu item Connection without confirmation.
- ▷ For pairing purposes, define any number as the Bluetooth passkey, e.g. 1. This Bluetooth passkey is no longer required after pairing has been successful.
- ▷ The ignition is switched on.

 Pair the mobile phone with the vehicle only when the car is stationary, to avoid endangering the car's occupants and other road users by being distracted. ◀

Switch on ignition

1. Insert remote control all the way into the ignition lock.
2. Switch on ignition without operating the brake or clutch or pressing the start/stop button.

Preparation via iDrive

iDrive, for operating principle refer to page 16.

3. Press the **MENU** button to call up the start menu.



4. Call up the **i** menu by pressing the controller.
5. Select "Settings" and press the controller.



6. Select "Bluetooth" and press the controller.
7. If necessary, move the highlight marker to the uppermost field. Turn the controller

until "Bluetooth" is selected and press the controller.



8. Select "Phone" and press the controller.



Preparation via the mobile phone

9. Further steps must be carried out with the mobile phone and vary depending on the model. Please refer to your mobile phone's operating instructions, e.g. under the topics of Searching for a Bluetooth device, Connecting or Pairing.

Pairing

Depending on your mobile phone, you will see messages, first in the mobile phone's display or on the Control Display, requesting you to enter the same Bluetooth passkey previously determined by you.

Message on the Control Display if the Bluetooth passkey can be entered via iDrive:

10. Select "Add device" and press the controller.



11. Enter the Bluetooth passkey.
Depending on the mobile phone, you will have approx. 30 seconds to enter your Bluetooth passkey on the mobile phone and the Control Display.

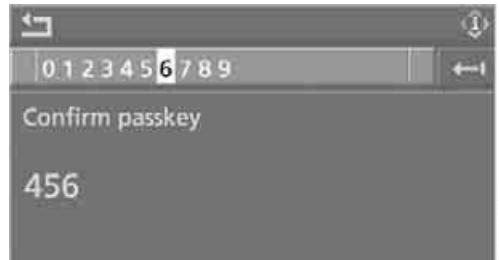

12. Select "Confirm passkey" and press the controller.
13. Wait several seconds until the list of paired mobile phones is displayed on the Control Display and "Phone" is selected.

To interrupt the mobile phone's pairing with the vehicle:

Select "Refuse connection" and press the controller.

The next time you use the mobile phone inside the vehicle, it will be recognized within no more than two minutes as long as the engine is running or the ignition is switched on.

As soon as a mobile phone is detected by the vehicle, the phone book entries stored on the SIM card or on your mobile phone are transmitted to the vehicle. Refer also your mobile phone's operating instructions, if necessary. This data transfer depends on your mobile phone and can take several minutes; please

refer to your mobile phone's operating instructions, if necessary.

Up to four mobile phones can be paired, one after the other. If a fifth mobile phone is paired, the pairing data for the last mobile phone on the list is deleted, refer also to the information below.

List of paired mobile phones

All mobile phones with pairing data stored by the vehicle can be displayed. If several mobile phones are detected by the vehicle at the same time, the mobile phone at the top of the list can be operated via the vehicle.

You can change the order of the mobile phones on the list. As long as a mobile phone from this list is selected, you cannot operate the mobile phones via the vehicle.

iDrive, for operating principle refer to page 16.

1. Press the **MENU** button to call up the start menu.
2. Call up the **i** menu by pressing the controller.
3. Select "Settings" and press the controller.
4. Select "Bluetooth" and press the controller.
5. If necessary, move the highlight marker to the uppermost field. Turn the controller until "Bluetooth" is selected and press the controller.
6. Select "Phone" and press the controller.
7. Select the desired mobile phone and press the controller.



8. Select "Move device up" and press the controller.

The selected mobile phone moves up one position on the list.



Unpairing the mobile phone from the vehicle

Should you no longer wish to operate your mobile phone via the vehicle, you can delete the mobile phone's pairing data.

iDrive, for operating principle refer to page 16.

1. Press the **MENU** button to call up the start menu.
2. Call up the **i** menu by pressing the controller.
3. Select "Settings" and press the controller.
4. Select "Bluetooth" and press the controller.
5. If necessary, move the highlight marker to the uppermost field. Turn the controller until "Bluetooth" is selected and press the controller.
6. Select "Phone" and press the controller.
7. Select the desired mobile phone and press the controller.



8. Select "Delete device" and press the controller.
The unpaired mobile phone is deleted from the list.
The phone book entries which were trans-

ferred from your mobile phone to the vehicle are also deleted in the process.

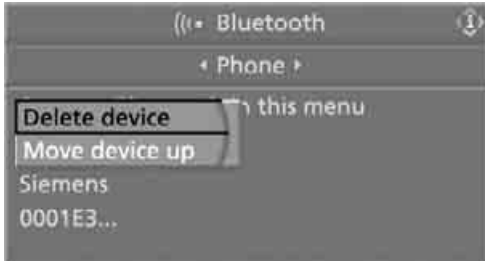

until "Bluetooth" is selected and press the controller.



Activating/deactivating the Bluetooth link

 The use of Bluetooth technology is not permitted in all countries. Observe all applicable local regulations. You can temporarily disconnect the Bluetooth link between the vehicle and the mobile phone, if necessary. ◀

If the Bluetooth link is deactivated, you can no longer operate the mobile phone via the vehicle, and other devices with a Bluetooth interface can be used in combination with the mobile phone, e.g. a laptop.

To temporarily deactivate the Bluetooth link between the vehicle and your mobile phone:

1. Take the mobile phone out of the snap-in adapter and switch it off.
2. Press the **MENU** button to call up the start menu.
3. Select the **i** menu and press the controller.
4. Select "Settings" and press the controller.
5. Select "Bluetooth" and press the controller.
6. If necessary, move the highlight marker to the uppermost field. Turn the controller

7. Select "Settings" and press the controller.  The Bluetooth link is activated.
8. Select "Bluetooth communication active" and press the controller to activate or deactivate the link.

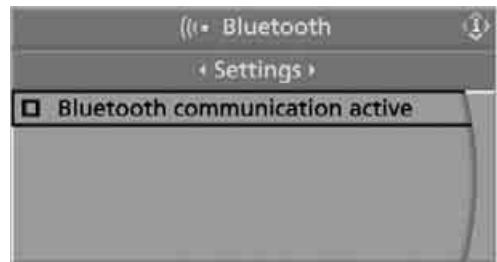

Adjusting volume

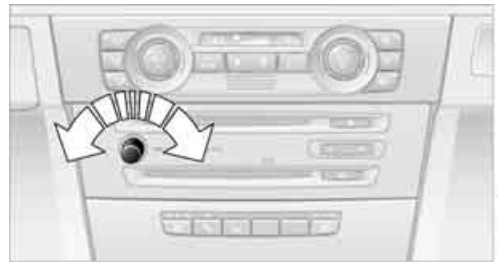

Turn the knob during a call to select the desired volume.

This volume for the hands-free system is maintained, even if the other audio sources are set to minimum volume.

You can also adjust the volume with buttons on the steering wheel, refer to page 10.

The setting is stored for the remote control currently in use.

Operation via iDrive

You can operate the following functions using iDrive:

- ▷ dialing phone numbers
- ▷ Selecting phone numbers from the phone book
- ▷ Selecting stored phone numbers, e.g. from the list of accepted calls
- ▷ Ending a call

When the ignition and radio readiness are switched off, e.g. after taking the remote control out of the ignition switch, you can continue an ongoing call via the hands-free system for no more than 25 minutes.

Requirements

The mobile phone's pairing data are stored by the vehicle and the mobile phone is operational. The engine is running or the ignition is switched on.

The mobile phone is recognized by the vehicle. iDrive, for operating principle refer to page 16.

1. Press the **MENU** button.



This opens the start menu.

2. Move the controller forwards to call up "Communication".

Receiving calls

If you have the phone number of the caller stored in the phone book and the phone number has been transmitted, the name of the entry is displayed.

Accepting a call



Select "Accept" and press the controller.

Rejecting a call

Select "Reject" and press the controller. The caller is diverted to your mailbox if it has been activated.

Calling

Dialing phone numbers

1. Select "Phone" and press the controller.



2. Select "Dial" and press the controller.
3. Enter the desired phone number by selecting the digits individually and pressing the controller. Always enter the complete phone number consisting of national dialing code, area code, and phone number. The letters correspond to the numbers on the keypad of the mobile phone. To delete an incorrect number or letter: Move the controller towards the right to select , and press the controller.

4. Select "Dial number" and press the controller.



Ending a call

1. Select the phone number and press the controller.



2. Select "End call" and press the controller.



Selecting a phone number from the phone book or from a list of stored phone numbers

Phone numbers you have dialed, received calls and phone book entries are stored in lists when the mobile phone is connected to the vehicle via Bluetooth. If the caller is listed in the phone book, the name of the entry is displayed instead of the phone number.

You can select the desired subscriber from the list and establish the connection.

Five lists are available:

- ▷ "A - Z"
The entries in your mobile phone's phone book, consisting of names and phone numbers, are sorted alphabetically.
- ▷ "Top 8"
The eight numbers dialed most frequently from the "A - Z" phone book are automatically stored in the Top 8 list. The list is sorted by frequency.
- ▷ "Redial"
The last eight phone numbers you have dialed are automatically stored. The last number dialed is at the top of the list.
- ▷ "Missed calls"
The phone numbers of the last eight rejected calls are stored. This requires the telephone number of the caller to have been transmitted.
- ▷ "Received calls"
The phone numbers of the last eight accepted calls are stored. This requires the telephone number of the caller to have been transmitted.

Selecting phone numbers from phone book

The "A - Z" list is available for your phone book entries. The phone book entries appear on the Control Display.

1. Select "Phone" and press the controller.



2. Select "A - Z" and press the controller.
3. To limit the number of displayed entries, select the initial letter of the desired entry and press the controller.

4. Select the desired entry and press the controller.

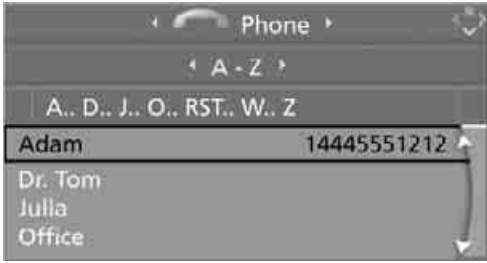

5. Select "Call" and press the controller.
The system dials the number.

If different phone numbers are stored in the mobile phone under one name, e.g. office and home, the name is shown once for each phone number.

You can change a phone number stored in the phone book, e.g. to call a specific extension:

1. Select "Phone" and press the controller.
2. Select "A - Z" and press the controller.
3. Select the desired entry and press the controller.
4. Select "Add digits" and press the controller.
5. Change the phone number.
6. Select "Dial number" and press the controller.

Dialing stored phone numbers from a list

To select an entry and establish a connection:

1. Select "Phone" and press the controller.
2. Select a list and press the controller:
 - ▷ "Top 8"
 - ▷ "Redial"
 - ▷ "Missed calls"
 - ▷ "Received calls"



3. Select the desired entry and press the controller.



4. Select "Call" and press the controller.
The system dials the number.

Deleting an individual entry

1. Select the desired entry from the list and press the controller.
2. Select "Delete" and press the controller.
The entry is deleted.



Deleting the entire list

1. Select an entry from the list and press the controller.
2. Select "Delete all numbers" and press the controller.



3. If applicable, select "Yes" and press the controller.
The list is deleted.

BMW Contact*

If you have not enabled BMW Assist, you can have several service numbers displayed:

- ▷ Roadside Assistance* of the BMW Group if you need help in the event of a breakdown
- ▷ BMW Service if you wish to schedule a service appointment, for example
- ▷ BMW Customer Relations* for information related to your vehicle

If BMW Assist is enabled, refer to page 190.

You can dial the displayed service numbers if your mobile phone is paired with the vehicle.

iDrive, for operating principle refer to page 16.

1. Press the **MENU** button.
This opens the start menu.
2. Move the controller forwards to select "Communication".

3. Select "BMW Contact" and press the controller.



4. Select "BMW Contact Numbers" and press the controller.



5. Select one of the following menu items and press the controller:
 - ▷ "Roadside Assistance"
 - ▷ "Customer Relations"
 - ▷ "Service Request"
6. Select "Call" and press the controller.
Contact will be established.

Dialing phone numbers via touch tones

Touch-tone dialing is required for access to network services or for controlling devices, e.g. for remote querying on an answering machine.

This function is available whenever there is a connection.

1. Establish connection.



2. Move the controller backwards until the bottom field is selected.
3. Select the desired touch-tone button and press the controller. Each selection is transmitted immediately and is confirmed by a tone, depending on the type of mobile phone you are using.



Switching between mobile phone and hands-free system

From mobile phone to hands-free system

You can continue ongoing calls outside of the vehicle's Bluetooth range via the hands-free system as long as the engine is running or the ignition is switched on. Depending on your mobile phone, the system automatically switches to hands-free mode.

With mobile phones that do not automatically switch to hands-free mode:

- ▷ Depending on the type of mobile phone you are using, you can continue the conversation via the hands-free system, if necessary. Refer to the display on your mobile phone

and/or your mobile phone's operating instructions.

- ▷ Press the  button above the storage compartment. The changeover can take several seconds.

From hands-free system to mobile phone

If you are making a call via the hands-free system, you can also continue the call via the mobile phone, if necessary, depending on the mobile phone model. Refer to the display on your mobile phone and/or your mobile phone's operating instructions.

Operation by voice commands*

The concept

You can operate your mobile phone without having to take a hand off the steering wheel. During your entries, you will be guided in many cases by announcements and questions.

The same prerequisites apply as for operation via iDrive, refer to page 181.

Symbols in the Owner's Manual

-  ›...‹ Say the specified commands word for word.
- ›)›...‹‹ Indicates responses of the system.

Saying commands

Activating the system

1. Briefly press the  button on the steering wheel. A sound signal indicates that you can say commands.
2. Say the command. The text or numbers that the voice command system has registered will appear on the Control Display.

Ending/canceling operation by voice commands

Briefly press the  button on the steering wheel or

 ›Cancel‹.

In dialogs where text is spoken, e.g. a name rather than a command, canceling is only possible using the button on the steering wheel.

Having the possible commands read aloud

The system recognizes specific commands that must be pronounced exactly word for word. You can have the possible commands for any function read aloud to you:

 ›Help‹

Using alternative commands

Often there is more than a single command to run a function, e.g.:

 ›Dial name‹ or ›Name‹.

Digits from zero to nine are recognized.

You can say each digit individually or group them into a sequence to accelerate the input.

Example: dialing phone numbers

Start the dialog:

Press the  button on the steering wheel.

Command	Response
›Dial number‹ e.g. ›123 456 7890‹	››Please say the number‹‹ Depending on your equipment version: ››123 456 7890. Continue?‹‹ or ››123 456 7890. And next?‹‹
›Dial‹	››Dialing number‹‹

Adjusting volume

You can adjust the volume for the instructions from the system:

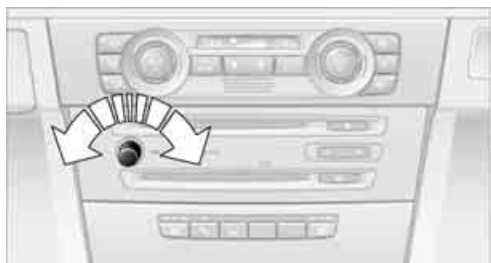

Turn the button during an instruction to select the desired volume.

This volume for the instructions is maintained, even if the other audio sources are set to minimum volume.

The setting is stored for the remote control currently in use.

Calling

Dialing phone numbers

- ›Dial number‹.
The dialog for establishing a telephone connection is opened.
- Say the phone number.
For telephone calls abroad, say ›Plus‹ and then the country code.
- ›Dial‹.
The connection to the desired subscriber is established.

Correcting phone numbers

After the last spoken sequence of digits has been repeated by the system, you can delete this sequence of digits.

- ›Correct number‹.
The digits are deleted.

The command ›Correct number‹ can be repeated as often as you like.

Deleting entry

›Delete‹ is used to delete all the digits entered so far.

Voice phone book

The phone book entries can be called up automatically from your mobile phone's memory.

Selecting an entry

The connection to the phone number of the selected entry is established.

1. ›Dial name‹.
The dialog for selecting an entry is opened.
2. Say the name when prompted.
3. Confirm the prompt with ›Yes‹.

Redialing

The ›Redial‹ command calls up "Redial".

Notes

 The commands in English were available as of this printing. Other languages are currently in preparation. To operate the mobile phone via the voice command system, refer to page 22. ◀

Important for voice commands

For voice commands, bear in mind the following:

- ▷ Pronounce the commands smoothly and at normal volume, avoiding excessive emphases and pauses.
- ▷ Keep the doors, windows and glass sunroof closed to prevent interference from outside noise.
- ▷ Avoid ambient noise in the vehicle while speaking.

Inserting/removing snap-in adapter

1. Press area **1** around the button and take off the cover.

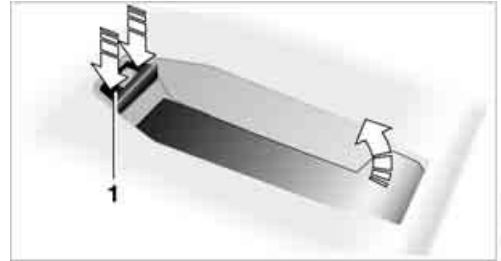

2. Insert the snap-in adapter in the front and press it downward until it engages.



To remove the snap-in adapter:
Press area **1** around the button.

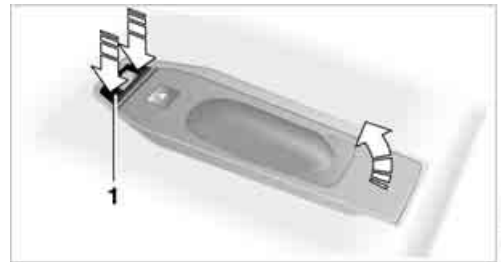

Inserting mobile phone

1. If applicable, remove the protective cap from the mobile phone's antenna connector so that the mobile phone can engage in the snap-in adapter.
2. With its buttons facing upward, slide the mobile phone up towards the electrical con-

tact points and press it downward until it engages.

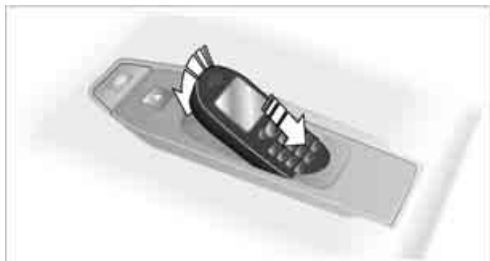

The mobile phone's battery is charged as soon as the vehicle is in radio readiness or the steering is unlocked.

 To conserve battery power, you should avoid using the mobile phone when the ignition is switched off. ◀

Remove the mobile phone

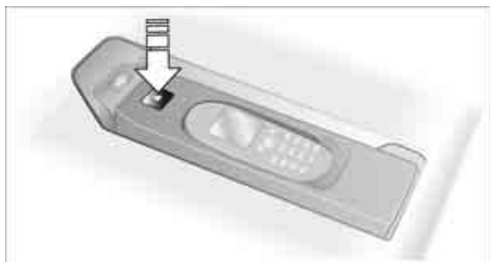

Press the button.

BMW Assist*

BMW Assist provides you with various services. For example, the position data of your vehicle can be transmitted to the BMW Assist Response Center if an emergency call* has been initiated.

Many BMW Assist services depend on the individually agreed contract.

After your contract has expired, the BMW Assist system will be deactivated by the BMW Assist Response Center without you having to visit a BMW center. After the BMW Assist system has been deactivated, no BMW Assist service will be available. The BMW Assist system can be reactivated by a BMW center after a new contract has been signed.

Requirements

You can use BMW Assist when the following requirements are met:

- ▷ The installed BMW Assist system is logged onto a mobile phone network. This network must be capable of transmitting the services.
- ▷ To transmit position data, the vehicle must be able to determine the current position.
- ▷ A GPS signal must be available in order for BMW Assist to be activated and updated.
- ▷ You have subscribed to BMW Assist with your BMW center or BMW Assist Response Center and signed a service contract. Activation must have been completed.
- ▷ BMW Assist is activated, refer to page 195.

Offered services

The following services are available via BMW Assist:

- ▷ **Emergency Request**, refer to page 229: When you press the SOS button, a connection is established to the BMW Assist Response Center. The BMW Assist

Response Center contacts you and takes further steps to help you.

- ▷ **Automatic Collision Notification:** Under certain conditions, a connection is established to the BMW Assist Response Center after a serious accident. If possible, the BMW Assist Response Center then speaks with you and takes further steps to help you.
- ▷ **Enhanced Roadside Assistance:** You can call BMW Roadside Assistance* should you require help in the event of a breakdown. If possible, the vehicle data and position data are transmitted during this call.
- ▷ **Customer Relations:** For all information related to your vehicle, you can be connected to BMW Customer Relations.
- ▷ **TeleService:** Data on your vehicle's service status or required inspections are transmitted to your BMW center either automatically before a service due date or when you request a BMW service appointment.
- ▷ **Remote Door Unlock:** Contact BMW Assist Customer Care if your remote control or key is not available and you would like to have the vehicle unlocked.
- ▷ **Stolen Vehicle Recovery:** After you report your vehicle stolen with the police, call BMW Assist Customer Care to determine its position.

In addition, optional services can be provided to you, such as Concierge service or information on directions, traffic or weather.

Press the SOS button in order to contact the BMW Assist Response Center, see below.

You can also access the BMW Assist Concierge services via the internet.

Characteristics of the offered services

The following characteristics apply to the services:

- ▶ The services offered are country-specific.
- ▶ Voice contact is established or data are transferred, depending on the equipment and the country. In some countries, it is possible to do both.
- ▶ The data transmitted can be vehicle data, for example, your current position, or the Condition Based Service CBS data.

Using services

Contacting the BMW Assist Response Center

You can establish contact with the BMW Assist Response Center via the SOS button.

1. Briefly press the cover flap to open. The arrangement of the switches and indicator lamps varies slightly among vehicle equipment versions.



2. Press the button for at least 2 seconds.

The BMW Assist Response Center will connect you with BMW Roadside Assistance.

Roadside Assistance

iDrive, for operating principle refer to page 16.

1. Press the **MENU** button. This opens the start menu.



2. Move the controller forwards to select "Communication".
3. If necessary, move the highlight marker to the uppermost field. Turn the controller until "BMW Assist" is selected and press the controller.

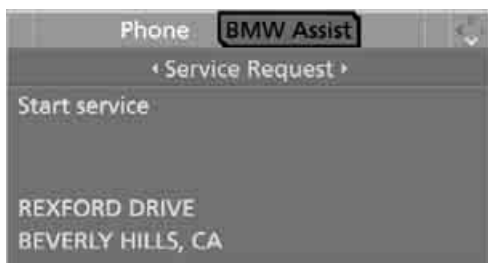

4. Select "Roadside Assistance" and press the controller.

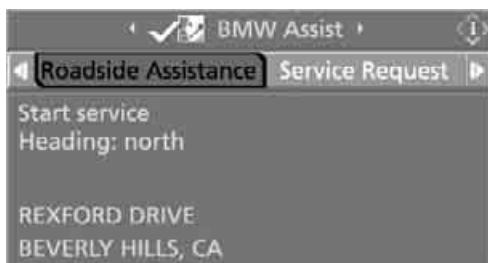

If the current location can be determined, the current vehicle position is displayed.

5. Select "Start service" and press the controller.

Contact with Roadside Assistance will be established.

TeleService

Automatic service notification*

The data on the service status of your vehicle or required inspections are transmitted automatically prior to the due date. You can check when the BMW center was notified.

1. Press the **MENU** button.
This opens the start menu.
2. Press the controller to open the **i** menu.
3. Select "Info sources" and press the controller.



4. Select "Service" and press the controller.
5. If necessary, move the highlight marker to the uppermost field. Turn the controller until "Service requirements" is selected and press the controller.

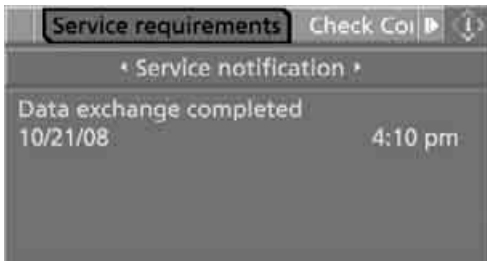

6. Select "Service notification" and press the controller.

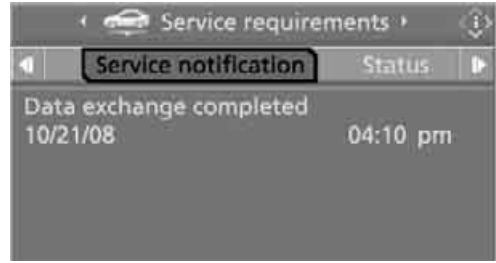

Manual service notification

You can transmit data regarding your vehicle's service status to your BMW center when you wish to arrange a service appointment.

1. Press the **MENU** button.
This opens the start menu.
2. Move the controller forwards to select "Communication".
3. If necessary, move the highlight marker to the uppermost field. Turn the controller until "BMW Assist" is selected and press the controller.

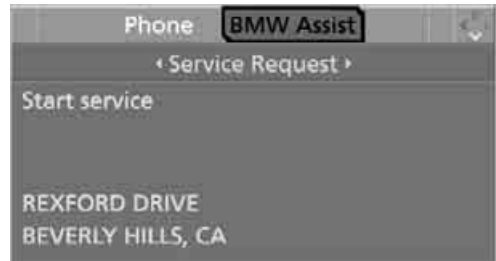

4. Select "Service Request"

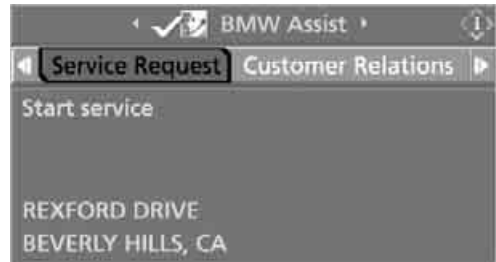

5. Press the controller.

6. Select "Start service" and press the controller.

The service-relevant data are transmitted. Your BMW center will contact you to arrange a service appointment.

Contacting BMW Customer Relations

For all information related to your vehicle you can call BMW Customer Relations.

1. Press the **MENU** button.
This opens the start menu.
2. Move the controller forwards to select "Communication".
3. If necessary, move the highlight marker to the uppermost field. Turn the controller until "BMW Assist" is selected and press the controller.

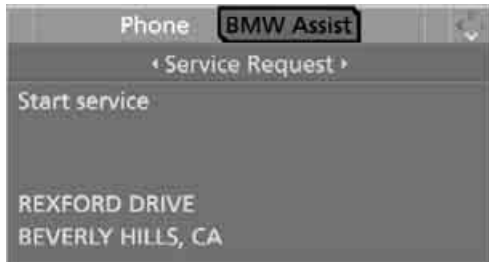

4. Select "Customer Relations".

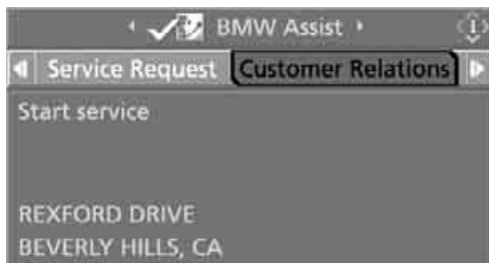

5. Press the controller.
6. Select "Start service" and press the controller.

The BMW Assist Response Center will connect you with BMW Customer Relations.

Concierge service*

When you call the BMW Assist Concierge, you can obtain information about, e.g., current events, gas stations or hotels, as well as receive the corresponding telephone numbers and addresses. Many hotels can be booked directly through the BMW Assist Concierge service.

Concierge service requires additional enabling by the BMW Assist Response Center.

Calling the Concierge

1. Press the **MENU** button.
This opens the start menu.
2. Move the controller forwards to select "Communication".
3. If necessary, move the highlight marker to the uppermost field. Turn the controller until "BMW Assist" is selected and press the controller.

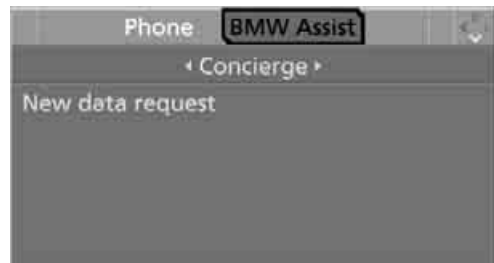

4. Select "Concierge" and press the controller.

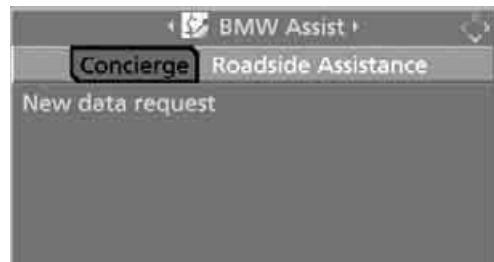

5. Select "New data request" and press the controller.

The BMW Assist Response Center will connect you with a BMW Assist Concierge.

Displaying transmitted data

Select a received message, if applicable, and press the controller.

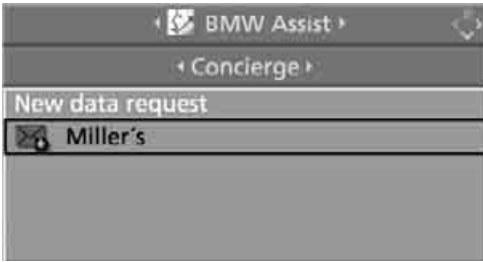

Dialing a phone number or transferring an address for destination guidance

1. Select "Options" and press the controller.



2. Select a menu item:
 - ▷ Press "Call" to make a telephone call. A prerequisite for this is that your Bluetooth mobile phone has been paired with the vehicle.
 - ▷ Press "Select as destination" to transfer the address to the navigation system for destination guidance.

Adapting BMW Assist

Displaying and updating services

If the services offered by BMW Assist change, you will be notified. In that event you may update the service functions.

1. Press the **MENU** button.
This opens the start menu.
2. Press the controller to open the **i** menu.

3. Turn the controller until "Settings" is selected and press the controller.



4. Turn the controller until "BMW Services" is selected and press the controller.



5. If necessary, move the highlight marker to the uppermost field. Turn the controller until "Service Status" is selected and press the controller.
The currently available BMW Assist services are displayed.
6. If necessary, select "Options" and press the controller.



7. Select "Update services" and press the controller.

Terminating services*

When you terminate the services, the connection to BMW Assist is deactivated.

1. Press the **MENU** button.
This opens the start menu.
2. Press the controller to open the **i** menu.
3. Turn the controller until "Settings" is selected and press the controller.
4. Turn the controller until "BMW Services" is selected and press the controller.



5. If necessary, move the highlight marker to the uppermost field. Turn the controller until "Service Status" is selected and press the controller.
6. Select "Options" and press the controller.



7. Select "Terminate services" and press the controller.

BMW Assist is blocked from use, and your vehicle's current position will not be transmitted during an emergency call*. To unblock the services, reactivate BMW Assist, see below. The contractual agreement is not affected by this. Reactivate BMW Assist, if necessary, to log on again.

Activating BMW Assist

BMW Assist must be activated to use the services.

Requirements

- ▷ Make sure that the vehicle can determine its current location. Reception is best when you have an unobstructed view to the sky.
- ▷ Leave vehicle ignition switched on during the activation process.

Activating

1. Press the **MENU** button.
This opens the start menu.



2. Press the controller to open the **i** menu.
3. Turn the controller until "Settings" is selected and press the controller.



4. Turn the controller until "BMW Services" is selected and press the controller.



5. If necessary, move the highlight marker to the uppermost field. Turn the controller

until "Service Status" is selected and press the controller.



6. Select "Enable services" and press the controller. BMW Assist is activated and data exchange with the BMW Assist Response Center begins.



Activation takes a few minutes. Progress status is displayed on the Control Display. If you open another menu, the activation process continues in the background.

Displaying vehicle data

When BMW Assist is activated, the license plate and the vehicle identification number of your vehicle may be displayed.

1. Open the start menu.
2. Press the controller to open the **i** menu.

3. Select "Settings" and press the controller.



4. Select "BMW Services" and press the controller.



5. If necessary, move the highlight marker to the uppermost field. Turn the controller until "Profile" is selected and press the controller.







Mobility

This section helps you maintain your car's mobility by supplying important information on vital topics including fuels and lubricants, wheels and tires, service, maintenance and breakdown assistance.

Refueling

⚠ Always switch off the engine before refueling, otherwise, fuel cannot be added to the tank and a message will be displayed. ◀

⚠ Take all precautionary measures and observe all applicable regulations when handling fuel. Do not carry any spare fuel containers in your vehicle. They can develop a leak and cause an explosion or cause a fire in the event of an accident. ◀

Gas cap

Opening

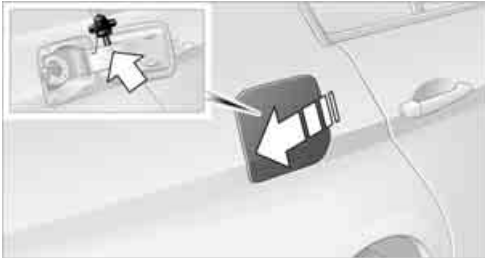

1. Open fuel filler door. To do so, lightly press the rear edge.
2. Turn the gas cap counterclockwise.
3. Place the gas cap in the bracket attached to the fuel filler door.

Closing

Fit the cap and turn it clockwise until you clearly hear a click.

⚠ Do not jam the strap between the gas cap and the vehicle. Otherwise fuel vapors could escape. A message will be displayed if the gas cap is loose or missing. ◀

Manually releasing the fuel filler door

In the event of a malfunction, you can release the fuel filler door manually:

Sedan



1. Remove the cover from the right-hand side-wall of the cargo bay.
2. Pull the knob with the fuel pump symbol. The fuel filler door is released.

Sports Wagon

1. Fold up the cargo bay floor panel.
2. Remove the cover from the right-hand side-wall of the cargo bay. To do so, turn the screws, arrows 1, 90° and take out the cover, arrow 2.

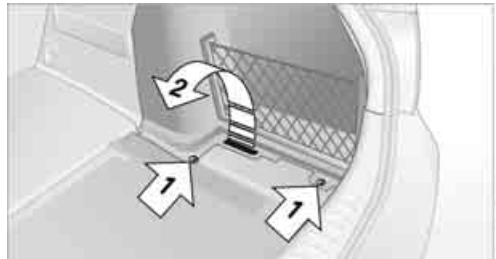

3. Pull the knob with the fuel pump symbol. The fuel filler door is released.

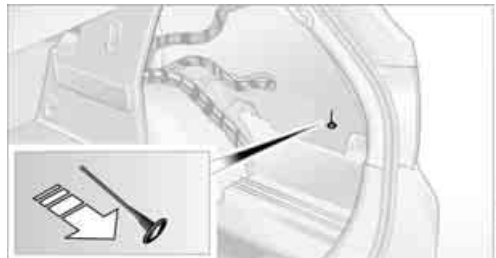

Observe the following when refueling

 When handling fuels always observe any safety guidelines posted at the service station. ◀

When refueling, insert the filler nozzle completely into the filler pipe. Avoid lifting the filler nozzle while filling the tank, as that would lead to

- ▷ premature pump shutoff
- ▷ a reduced efficiency of the fuel-vapor recovery system.

The fuel tank is full when the filler nozzle clicks off the first time.

Fuel tank capacity

Approx. 16.1 US gallons/61 liters, including the reserve capacity of 2.1 US gallons/8 liters.

 Refuel as soon as possible once your cruising range falls below 30 miles/ 50 km, otherwise engine functions are not ensured and damage can occur. ◀

Fuel specifications

 Do not fill the tank with leaded fuel, as this would cause permanent damage to the catalytic converter.

Do not fill the tank with E85, i.e. fuel containing 85% ethanol, nor with FlexFuel. Otherwise the engine and fuel supply system will be damaged. ◀

Required fuel

Super Premium Gasoline/AKI 91

This gasoline is highly recommended.

However, you may also use gasoline with less AKI. The minimum AKI Rating is:

- ▷ 323i, 328i/xi: 87
- ▷ 335i: 89.

If you use gasoline with this minimum AKI Rating, the engine may produce knocking sounds when starting at high outside temperatures. This has no effect on the engine life.

 Do not use any gasoline below the specified minimum fuel grade. Otherwise the engine could be damaged. ◀

Use high-quality brands

Field experience has indicated significant differences in fuel quality: volatility, composition, additives, etc., among gasolines offered for sale in the United States and Canada. Fuels containing up to and including 10% ethanol or other oxygenates with up to 2.8% oxygen by weight, that is, 15% MTBE or 3% methanol plus an equivalent amount of co-solvent, will not void the applicable warranties with respect to defects in materials or workmanship.

 The use of poor-quality fuels may result in drivability, starting and stalling problems especially under certain environmental conditions such as high ambient temperature and high altitude.

Should you encounter driveability problems which you suspect could be related to the fuel you are using, we recommend that you respond by switching to a recognized high-quality brand such as gasoline that is advertised as Top Tier Detergent Gasoline.

Failure to comply with these recommendations may also result in unscheduled maintenance. ◀

Wheels and tires

Tire inflation pressures

Information for your safety

It is not merely the tires' service life, but also driving comfort and, to a great extent, driving safety that depend on the condition of the tires and the maintenance of the specified tire pressure.

 Check the tire inflation pressure regularly and correct it, if necessary: at least twice a month and before starting long trips. If you fail to observe this precaution you may be driving on tires with incorrect tire pressures, a condition that can not only compromise your vehicle's driving stability, but also lead to tire damage and the risk of an accident. Do not drive with deflated, i.e. flat tires, except when using Run-Flat Tires. A flat tire will seriously impair your vehicle's handling and braking response. Attempts to drive on a flat tire can lead to loss of control over the vehicle. ◀

Checking pressure

Only check tire inflation pressure when the tires are cold. This means after a maximum of 1.25 miles/2 km driving or when the vehicle has been parked for at least 2 hours. When tires are warm, the tire inflation pressure is higher.

 After correcting tire inflation pressures, always reinitialize the Flat Tire Monitor, refer to page 90. ◀

Inflation pressure specifications

The tables below provide all the correct inflation pressures for the specified tire sizes at ambient temperature.

 The inflation pressures apply to the tire sizes approved and tire brands recommended by BMW; a list of these is available from your BMW center. ◀

For correct identification of the right tire inflation pressures, observe the following:

- ▷ Tire sizes for your vehicle

- ▷ Load conditions
- ▷ Maximum allowable driving speed

Tire inflation pressures for driving up to 100 mph or 160 km/h

For normal driving up to 100 mph or 160 km/h and to achieve optimum driving comfort, adjust pressures to the respective tire inflation pressures listed on the following pages in the columns for traveling speeds up to a maximum of 100 mph or 160 km/h.

These tire inflation pressures can also be found on the driver's-side door post when the driver's door is open.





 The maximum permissible speed for these tire pressures is 100 mph or 160 km/h. Do not exceed this speed, otherwise tire damage and accidents could occur. ◀

Tire inflation pressures for driving above 100 mph or 160 km/h







 In order to drive at maximum speeds in excess of 100 mph or 160 km/h, adjust pressures to the respective tire inflation pressures listed on the following pages in the columns for traveling speeds including those exceeding 100 mph or 160 km/h. Otherwise tire damage and accidents could occur. ◀

Observe all national and local maximum speed limits, otherwise violations of the laws could occur.

Sedan: tire inflation pressures for the 323i, for Canada only

Tire size	Pressure specifications in psi/kPa					
	Traveling speeds up to a max. of 100 mph / 160 km/h			Traveling speeds including those exceeding 100 mph / 160 km/h		
All pressure specifications in the table are indicated in psi/kilopascal with cold tires. Cold = ambient temperature						
without Sports package						
205/55 R 16 91 H M+S						
225/50 R 16 92 V						
225/50 R 16 92 H M+S	32/220	35/240	32/220	33/230	32/220	39/270
225/45 R 17 91 H M+S						
225/45 R 17 94 V M+S XL	32/220	36/250	32/220	33/230	32/220	39/270
Front: 225/45 R 17 91 V	32/220	-	32/220	-	32/220	-
Rear: 255/40 R 17 94 V	-	32/220	-	32/220	-	35/240
Front: 225/40 R 18 88 W	32/220	-	32/220	-	32/220	-
Rear: 255/35 R 18 90 W	-	36/250	-	33/230	-	39/270
Front: 225/35 R 19 88 Y XL	35/240	-	32/220	-	35/240	-
Rear: 255/30 R 19 91 Y XL	-	41/280	-	33/230	-	41/280
with Sports package						
225/50 R 16 92 V						
225/50 R 16 92 H M+S						
205/55 R 16 91 H M+S	32/220	35/240	32/220	35/240	35/240	42/290
225/45 R 17 91 H M+S						
225/45 R 17 94 V M+S XL	32/220	36/250	32/220	38/260	38/260	45/310
Front: 225/45 R 17 91 V	32/220	-	32/220	-	35/240	-
Rear: 255/40 R 17 94 V	-	32/220	-	35/240	-	42/290
Front: 225/40 R 18 88 W	32/220	-	33/230	-	36/250	-
Rear: 255/35 R 18 90 W	-	36/250	-	36/250	-	44/300
Front: 225/35 R 19 88 Y XL	35/240	-	33/230	-	38/260	-
Rear: 255/30 R 19 91 Y XL	-	41/280	-	36/250	-	44/300
More details on the permissible load and weights can be found on page 239 .						

Sedan: tire inflation pressures for the 328i

Tire size	Pressure specifications in psi/kPa					
	Traveling speeds up to a max. of 100 mph / 160 km/h			Traveling speeds including those exceeding 100 mph / 160 km/h		
All pressure specifications in the table are indicated in psi/kilopascal with cold tires. Cold = ambient temperature						
						

without Sports package

205/55 R 16 91 H M+S

225/50 R 16 92 V

225/50 R 16 92 H M+S

225/45 R 17 91 H M+S

32/220 36/250 32/220 35/240 32/220 39/270

225/45 R 17 94 V M+S XL

32/220 36/250 32/220 35/240 33/230 41/280

Front: 225/45 R 17 91 V

32/220 - 32/220 - 32/220 -

Rear: 255/40 R 17 94 V

- 32/220 - 32/220 - 36/250

Front: 225/40 R 18 88 W

32/220 - 32/220 - 32/220 -

Rear: 255/35 R 18 90 W

- 36/250 - 35/240 - 39/270

Front: 225/40 R 18 88 Y

32/220 - 32/220 - 32/220 -

Rear: 255/35 R 18 90 Y

- 36/250 - 32/220 - 36/250

Front: 225/35 R 19 88 Y XL

35/240 - 32/220 - 35/240 -

Rear: 255/30 R 19 91 Y XL

- 41/280 - 35/240 - 41/280

Tire size	Pressure specifications in psi/kPa					
	Traveling speeds up to a max. of 100 mph / 160 km/h		Traveling speeds including those exceeding 100 mph / 160 km/h			
All pressure specifications in the table are indicated in psi/kilopascal with cold tires. Cold = ambient temperature with Sports package						
205/55 R 16 91 H M+S						
225/50 R 16 92 V						
225/50 R 16 92 H M+S	32/220	36/250	32/220	36/250	36/250	44/300
225/45 R 17 91 H M+S						
225/45 R 17 94 V M+S XL	32/220	36/250	32/220	39/270	39/270	46/320
Front: 225/45 R 17 91 V	32/220	-	32/220	-	36/250	-
Rear: 255/40 R 17 94 V	-	32/220	-	35/240	-	41/280
Front: 225/40 R 18 88 W	32/220	-	33/230	-	38/260	-
Rear: 255/35 R 18 90 W	-	36/250	-	38/260	-	44/300
Front: 225/40 R 18 88 Y	32/220	-	32/220	-	32/220	-
Rear: 255/35 R 18 90 Y	-	36/250	-	35/240	-	41/280
Front: 225/35 R 19 88 Y XL	35/240	-	33/230	-	38/260	-
Rear: 255/30 R 19 91 Y XL	-	41/280	-	38/260	-	44/300

More details on the permissible load and weights can be found on page [239](#).

Sedan: tire inflation pressures for the 328xi

Tire size	Pressure specifications in psi/kPa					
	Traveling speeds up to a max. of 100 mph / 160 km/h			Traveling speeds including those exceeding 100 mph / 160 km/h		
All pressure specifications in the table are indicated in psi/kilopascal with cold tires. Cold = ambient temperature						

without Sports package:



205/55 R 16 91 H M+S						
225/50 R 16 92 H M+S	32/220	36/250	32/220	35/240	35/240	41/280
225/45 R 17 91 H M+S						
225/45 R 17 94 V M+S XL						
Front: 225/45 R 17 91 V	32/220	-	32/220	-	35/240	-
Rear: 255/40 R 17 94 V	-	32/220	-	32/220	-	36/250

with Sports package:

205/55 R 16 91 H M+S						
225/50 R 16 92 H M+S	32/220	36/250	32/220	35/240	35/240	41/280
225/45 R 17 91 H M+S						
225/45 R 17 94 V M+S XL	32/220	36/250	35/240	38/260	39/270	45/310
Front: 225/45 R 17 91 V	32/220	-	33/230	-	38/260	-
Rear: 255/40 R 17 94 V	-	32/220	-	33/230	-	39/270

More details on the permissible load and weights can be found on page [239](#).

Sedan: tire inflation pressures for the 335i

Tire size	Pressure specifications in psi/kPa					
	Traveling speeds up to a max. of 100 mph / 160 km/h		Traveling speeds including those exceeding 100 mph / 160 km/h			
All pressure specifications in the table are indicated in psi/kilopascal with cold tires. Cold = ambient temperature						
	without Sports package:					
	225/45 R 17 91 H M+S	32/220	38/260	32/220	36/250	35/240
225/45 R 17 94 V M+S XL	32/220	38/260	32/220	36/250	35/240	42/290
Front: 225/45 R 17 91 V	32/220	-	32/220	-	33/230	-
Rear: 255/40 R 17 94 V	-	33/230	-	32/220	-	36/250
Front: 225/40 R 18 88 W	32/220	-	32/220	-	36/250	-
Rear: 255/35 R 18 90 W	-	38/260	-	36/250	-	41/280
Front: 225/40 R 18 88 Y	32/220	-	32/220	-	33/230	-
Rear: 255/35 R 18 90 Y	-	38/260	-	32/220	-	38/260
Front: 225/35 R 19 88 Y XL	38/260	-	35/240	-	38/260	-
Rear: 255/30 R 19 91 Y XL	-	42/290	-	36/250	-	42/290
with Sports package:						
225/45 R 17 91 H M+S	32/220	38/260	32/220	36/250	35/240	42/290
225/45 R 17 94 V M+S XL	32/220	38/260	35/240	41/280	39/270	46/320
Front: 225/45 R 17 91 V	32/220	-	33/230	-	38/260	-
Rear: 255/40 R 17 94 V	-	33/230	-	35/240	-	41/280
Front: 225/40 R 18 88 W	32/220	-	35/240	-	39/270	-
Rear: 255/35 R 18 90 W	-	38/260	-	39/270	-	45/310
Front: 225/40 R 18 88 Y	32/220	-	32/220	-	35/240	-
Rear: 255/35 R 18 90 Y	-	38/260	-	35/240	-	41/280
Front: 225/35 R 19 88 Y XL	38/260	-	36/250	-	39/270	-
Rear: 255/30 R 19 91 Y XL	-	42/290	-	39/270	-	45/310

More details on the permissible load and weights can be found on page [239](#).

Sports Wagon: tire inflation pressures for the 328i

Tire size	Pressure specifications in psi/kPa					
	Traveling speeds up to a max. of 100 mph / 160 km/h			Traveling speeds including those exceeding 100 mph / 160 km/h		
All pressure specifications in the table are indicated in psi/kilopascal with cold tires. Cold = ambient temperature						

without Sports package:



205/55 R 16 91 H M+S						
225/50 R 16 92 H M+S	32/220	39/270	32/220	36/250	36/250	44/300
225/45 R 17 91 H M+S						
225/45 R 17 94 V M+S XL	33/230	41/280	32/220	38/260	38/260	45/310
Front: 225/45 R 17 91 V	32/220	-	32/220	-	36/250	-
Rear: 255/40 R 17 94 V	-	35/240	-	33/230	-	39/270
Front: 225/35 R 19 88 Y XL	38/260	-	32/220	-	38/260	-
Rear: 255/30 R 19 91 Y XL	-	45/310	-	38/260	-	45/310

with Sports package:

225/45 R 17 94 V M+S XL	33/230	41/280	35/240	42/290	44/300	51/350
Front: 225/45 R 17 91 V	32/220	-	32/220	-	38/260	-
Rear: 255/40 R 17 94 V	-	35/240	-	38/260	-	45/310
Front: 225/35 R 19 88 Y XL	38/260	-	33/230	-	41/280	-
Rear: 255/30 R 19 91 Y XL	-	45/310	-	41/280	-	48/330

More details on the permissible load and weights can be found on page [239](#).

Sports Wagon: tire inflation pressures for the 328xi

Tire size	Pressure specifications in psi/kPa					
	Traveling speeds up to a max. of 100 mph / 160 km/h			Traveling speeds including those exceeding 100 mph / 160 km/h		
All pressure specifications in the table are indicated in psi/kilopascal with cold tires. Cold = ambient temperature						
						

without Sports package:

205/55 R 16 91 H M+S						
225/50 R 16 92 H M+S	32/220	39/270	32/220	38/260	36/250	44/300
225/45 R 17 91 H M+S						
225/45 R 17 94 V M+S XL						
Front: 225/45 R 17 91 V	32/220	-	32/220	-	36/250	-
Rear: 255/40 R 17 94 V	-	35/240	-	32/220	-	39/270

with Sports package:

205/55 R 16 91 H M+S						
225/50 R 16 92 H M+S	32/220	39/270	32/220	38/260	36/250	44/300
225/45 R 17 91 H M+S						
225/45 R 17 94 V M+S XL	32/220	39/270	35/240	42/290	42/290	49/340
Front: 225/45 R 17 91 V	32/220	-	33/230	-	38/260	-
Rear: 255/40 R 17 94 V	-	35/240	-	36/250	-	44/300

More details on the permissible load and weights can be found on page [239](#).

Tire identification marks

Knowledge of the labeling on the side of the tire makes it easier to identify and choose the right tires.

Tire size

e.g. 225/45 R 17 91 V

Nominal width in mm

Aspect ratio in %

Radial belt construction

Rim diameter in inches

Load rating, not on ZR tires

Speed code letter, in front of the R on ZR tires

Speed code letter

Q = up to 100 mph or 160 km/h

T = up to 118 mph or 190 km/h

H = up to 131 mph or 210 km/h

V = up to 150 mph or 240 km/h

W = up to 167 mph or 270 km/h

Y = up to 186 mph or 300 km/h

Tire Identification Number

Tires with DOT codes meet the guidelines of the US Department of Transport.

DOT code:

e.g. DOT xxxx xxx 0705

Manufacturer's code for tire make

Tire size and tire design

Tire age

Tire age

The manufacturing date of tires is contained in the tire coding: DOT ... 3006 means that the tire was manufactured in week 30 of 2006.

BMW recommends that you replace all tires after 6 years at most, even if some tires may last for 10 years.

Uniform Tire Quality Grading

Quality grades can be found where applicable on the tire sidewall between tread shoulder and maximum section width. For example:

Tread wear 200 Traction AA Temperature A

DOT Quality Grades

Tread wear Traction AA A B C Temperature A B C



All passenger car tires must conform to Federal Safety Requirements in addition to these grades. ◀

Tread wear

The tread wear grade is a comparative rating based on the wear rate of the tire when tested under controlled conditions on a specified government test course. For example, a tire graded 150 would wear one and one-half (1½) times as well on the government course as a tire graded 100. The relative performance of tires depends upon the actual conditions of their use, however, and may depart significantly from the norm due to variations in driving habits, service practices and differences in road characteristics and climate.

Traction

The traction grades, from highest to lowest, are AA, A, B, and C.

Those grades represent the tire's ability to stop on wet pavement as measured under controlled conditions on specified government test surfaces of asphalt and concrete. A tire marked C may have poor traction performance.



The traction grade assigned to this tire is based on straight-ahead braking traction tests, and does not include acceleration, cornering, hydroplaning, or peak traction characteristics. ◀

Temperature

The temperature grades are A, the highest, B, and C, representing the tire's resistance to the generation of heat and its ability to dissipate heat when tested under controlled conditions on a specified indoor laboratory test wheel. Sustained high temperature can cause the material of the tire to degenerate and reduce tire life, and excessive temperature can lead to sudden tire failure. The grade C corresponds to a level of performance which all passenger car tires must meet under the Federal Motor Vehicle Safety Standard No. 109. Grades B and A represent higher levels of performance on the laboratory test wheel than the minimum required by law.



The temperature grade for this tire is established for a tire that is properly inflated and not overloaded. Excessive speed, underinflation, or excessive loading, either separately or in combination, can cause heat buildup and possible tire failure. ◀

RSC – Run-Flat Tires

You will recognize Run-Flat Tires by a circular symbol containing the letters RSC on the side of the tire, refer to page 212.

M+S

Winter and all-season tires. These have better winter properties than summer tires.

XL

Designation for specially reinforced tires.

Tire condition

Inspect your tires frequently for tread wear, signs of damage and for foreign objects lodged in the tread. Check the tread depth.

Minimum tread depth

The tread depth should not drop below 1/8 in/ 3 mm, although, for example, European legislation only specifies a minimum tread depth of

1/16 in/1.6 mm. At tread depths below 1/8 in/ 3 mm there is an increased risk of high-speed hydroplaning, even when only small amounts of water are present on the road surface. When winter tires wear down past a tread depth of 1/6 in/4 mm, they become perceptibly less suitable for winter conditions. In the interest of safety, new tires should be installed.

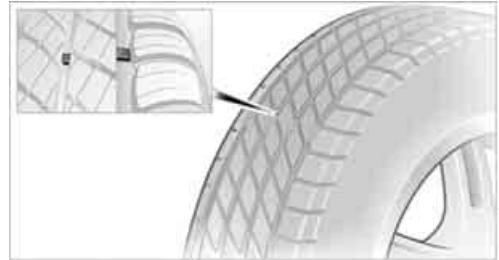

Wear indicators in the base of the tread groove are distributed around the tire's circumference; the letters TWI, for Tread Wear Indicator, on the tire's sidewalls identify tires that incorporate these wear indicators. Once the tire tread has worn down to the wear indicators, the tire has worn to a depth of 1/16 in/1.6 mm.

Wheel/tire damage

Please note that low-profile tires cause wheels, tires and suspension parts to be more susceptible to road hazard and consequential damages.

Unusual vibrations encountered during normal vehicle operation can indicate tire failure or some other vehicle defect. This can, for example, be caused by driving over curbs. The same applies to any other abnormal road behavior, such as pulling severely to the right or left.



In these cases, reduce speed immediately and have wheels and tires thoroughly checked. To do so, drive carefully to the nearest BMW center or tire shop that works according to BMW repair procedures with correspondingly trained personnel. If necessary, have the vehicle towed there.

Tire damage can be extremely dangerous for vehicle occupants and other road users. ◀

Tire age

For various reasons, such as the development of brittleness, BMW recommends tire replacement after no more than 6 years, regardless of the actual wear of the tires.

The manufacturing date of tires is contained in the tire coding:

DOT ... 0705 means that the tire was manufactured in week 07 of 2005.

Run-Flat Tires



The symbol identifying Run-Flat Tires is a circle with the letters RSC on the sidewall.

Run-Flat Tires comprise a conditionally self-supporting tire and a special rim. The reinforcement in the sidewalls ensures that the tire can continue to be used subject to certain restrictions, even if depressurized.

For information on continuing to drive with a flat tire, refer to Indication of a flat tire, page 91.

New wheels and tires

 Have new wheels and tires installed only by your BMW center or tire shop that works according to BMW repair procedures with correspondingly trained personnel. If this work is not carried out properly, there is a danger of subsequent damage and related safety hazards. Make sure that the new wheels are balanced. ◀

Retreaded tires

 BMW recommends that you do not use retreaded tires, since driving safety may

be impaired. The causes for this include potentially different tire casing structures and often wide variations in tire age, which can result in a limited service life. ◀

Correct wheels and tires

When mounting new tires or changing over from summer to winter tires and vice versa, mount Run-Flat Tires for your own safety. In the event of a flat, moreover, no spare wheel is available. Your BMW center will be glad to advise you.

 For safety reasons, BMW recommends that damaged Run-Flat Tires be replaced rather than repaired. ◀

 BMW recommends that you use only wheel and tire combinations that BMW has tested and approved for your particular vehicle. Variations in factors such as manufacturing tolerances mean that even wheels and tires with identical official size ratings could actually have different dimensions, which could lead to body contact and thus to severe accidents. If non-approved wheels and tires are used, BMW cannot evaluate their suitability, and therefore cannot guarantee their driving safety. ◀

You can inquire about the right wheel/tire combination at your BMW center.

The correct combination of wheels and tires is also necessary to ensure reliable operation of various vehicle systems such as ABS and DSC.

To maintain good handling and vehicle response, use only tires of a single brand and tread configuration. After a tire has been damaged, mount the previous wheel and tire combination again as soon as possible.

Wheels with Tire Pressure Monitor TPM electronics

When mounting new tires or changing over from summer to winter tires, or vice versa, only use wheels with TPM electronics; otherwise the Tire Pressure Monitor may not be able to detect a puncture, refer to page 91. Your BMW center will be glad to advise you.

Recommended tire brands

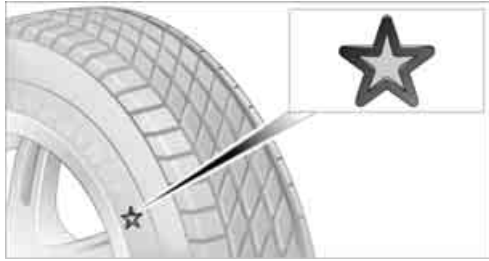

Certain makes of tire are recommended by BMW for each tire size. They are marked with a clearly visible BMW designation on the sidewall of the tire.

When properly used, these tires meet the highest standards in terms of safety and handling characteristics.

Special characteristics of winter tires

BMW recommends winter tires for use in cold winter driving conditions. Although all-season M+S tires provide better winter traction than summer tires, they generally fail to provide the same levels of cold-weather performance as winter tires.

Pay attention to speed



Always comply with the speed limit for the winter tires mounted on your car; failure to do so could result in tire damage and accidents. ◀

If the car is capable of speeds higher than that permitted for the winter tires, a label stating the maximum permitted speed for the mounted tires must be displayed in your field of view. Specialist tire dealers and your BMW center can supply these labels.

Storage

Always store wheels and tires in a cool, dry place with as little exposure to light as possible. Always protect tires against all contact with oil, grease and fuels. Do not exceed the maximum tire inflation pressure indicated on the sidewall of the tire.

Snow chains*

Only certain fine-link snow chains have been tested by BMW, classified as safe for use and recommended. Consult your BMW center for more information.

Snow chains must be mounted in pairs and on the rear wheels only. Observe the manufacturer's instructions when mounting snow chains. Do not exceed a speed of 30 mph or 50 km/h.



Do not initialize the Flat Tire Monitor if snow chains are mounted, otherwise the instrument might issue an incorrect reading. When driving with snow chains, you may find it helpful to activate DTC temporarily, refer to page 88. ◀

Under the hood

⚠ Do not work on the car unless you possess the necessary technical knowledge. If you are unfamiliar with the statutory guidelines, have any work on the vehicle performed only by a BMW center or by a workshop that work according to BMW repair procedures with correspondingly trained personnel. If this work is not carried out properly, there is a danger of subsequent damage and related safety hazards. ◀

Hood

Releasing

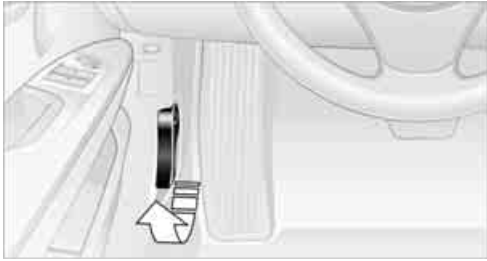

Pull the lever.

Opening



⚠ In order to avoid damage, make sure that the wiper arms are against the windshield before you open the hood. ◀

Press the release handle and open the hood.

Closing

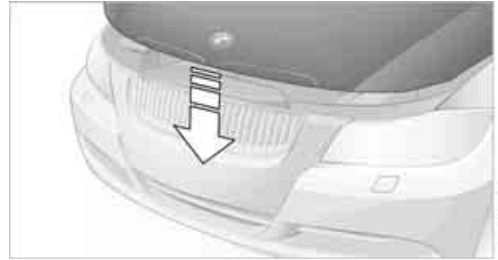

Close the hood from a height of approx. 16 in/ 40 cm with momentum. It must be clearly heard to engage.

⚠ Make sure that the closing path of the hood is clear, otherwise injuries may result.

If you see any signs while driving your vehicle that the hood is not completely closed, stop at once and close it securely. ◀

Important parts of the engine compartment



- 1 Expansion tank for coolant, refer to page 217
- 2 Washer fluid reservoir for headlamp cleaning system and window washer system, refer to page 63
- 3 Jump-starting connection, refer to page 230
- 4 Filler neck for engine oil, refer to Adding engine oil

Engine oil

The engine oil consumption is dependent on driving style and driving conditions.

Checking oil level

Your car is equipped with an electronic oil-level monitor.

For a precise measurement and display of the oil level, it is necessary that the engine be at operating temperature, i.e. after uninterrupted driving for at least approx. 6.5 miles/10 km. You can have the oil level displayed while you are driving, or while the vehicle is at a standstill on a level surface and the engine is running.

Display in the instrument cluster



1. Push button 1 in the turn indicator lever up or down repeatedly until the appropriate symbol is shown in the display, accompanied by the word "OIL".
2. Press button 2 in the turn indicator lever. The oil level is checked and the reading displayed.

Possible displays



- 1 Oil level OK
- 2 Oil level is being checked.
This can take about 3 minutes if the car is at a standstill on a level surface, or about 5 minutes while the car is on the move.
- 3 Oil level down to minimum:
Add engine oil as soon as possible, but no more than 1 US quart/1 liter, refer also to Adding engine oil on page 217.
- 4 Oil level is too high.
 Too much oil will harm the engine. Have the vehicle checked without delay. ◀
- 5 The oil level sensor is defective.
Do not add engine oil. You can continue your journey. Note the newly calculated distance remaining to the next oil service, refer to page 219. Have the system checked as soon as possible.

Display via iDrive

iDrive, for operating principle refer to page 16.

1. Press the **MENU** button.
This opens the start menu.
2. Press the controller to open the **i** menu.

3. Select "Info sources" and press the controller.



4. Select "Service" and press the controller.
5. If necessary, move the highlight marker to the uppermost field. Turn the controller until "Service requirements" is selected and press the controller.



6. If necessary, move the highlight marker to the second field from the top. Turn the controller until "Engine oil level" is selected and press the controller. The oil level is displayed.

Possible messages

- ▷ "Engine oil level O.K."
- ▷ "No measurement available: Updating engine oil level measurement..."
The engine oil level is measured. This can take about 3 minutes if the car is at a standstill on a level surface and the engine is running, and about 5 minutes while the car is on the move.
- ▷ "Oil level at the minimum! Refill with 1 quart of engine oil."
Add engine oil as soon as possible, but no more than 1 US quart/1 liter, refer also to Adding engine oil below.

- ▷ "Engine oil level too high"
 -  Too much oil will harm the engine. Have the vehicle checked without delay. ◀
- ▷ "Please observe recalculated service interval for engine oil"
 - Do not add engine oil. You can continue your journey. Note the newly calculated distance remaining to the next oil service, refer to page 77. Have the system checked as soon as possible.

Adding engine oil

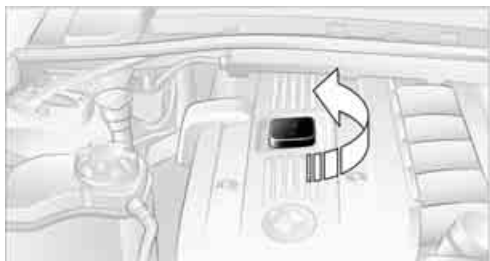

Do not add the maximum amount of 1 US quart/ 1 liter of engine oil until a corresponding message is shown on the Control Display.

 Add oil within the next 125 miles/200 km, otherwise the engine could be damaged. ◀

 Keep oils, greases, etc. out of the reach of children and comply with the relevant warnings on the containers. Otherwise, health hazards may result. ◀

Oil change

Have oil changed only at your BMW center or at a workshop that works according to BMW repair procedures with correspondingly trained personnel.

Specified engine oils

The quality of the engine oil selected has critical significance for the operation and service life of an engine. BMW continuously approves specific oils after confirming their suitability for use in its vehicles with extensive testing.

Only use approved BMW High Performance Synthetic Oil.

If BMW High Performance Synthetic Oil is not available, you can add small quantities of other synthetic oils in between oil changes. Only use oils with the API SH specification or higher.

 Your BMW center will be glad to answer any questions regarding BMW High Performance Synthetic Oil or approved synthetic oils. ◀

You can also call BMW of North America at 1-800-831-1117 or visit the website www.bmwusa.com to obtain this information.

Viscosity ratings

Viscosity is a measure of an oil's flow rating and is categorized in SAE classes.

Selecting the appropriate SAE class depends on the regional climatic conditions in which you normally drive your BMW.

 Approved oils belong to the 5W-40 and 5W-30 classes. ◀

These oils can be used for driving at all outside temperatures.

Coolant

 Do not add coolant to the cooling system when the engine is hot. Escaping coolant can cause burns. ◀

Coolant is a mixture of water and an additive. Not all commercially available additives are suitable for your BMW. Ask your BMW center for suitable additives.

 Only use suitable additives, otherwise engine damage may result. The additives are hazardous to your health. ◀

 Comply with the appropriate environmental protection regulations when disposing of coolant additives. ◀

Checking coolant level

1. The engine must be at ambient temperature.
2. Turn the cap of the expansion tank a little counterclockwise to allow any accumulated pressure to escape, then continue turning to open.
3. The coolant level is correct if it is between the maximum and minimum marks in the filler neck, refer also to the diagram next to the filler neck.



4. If the coolant is low, slowly add coolant up to the specified level; do not overfill.
5. Turn the cap until there is an audible click.
6. Have the reason for the coolant loss eliminated as soon as possible.

BMW Maintenance System

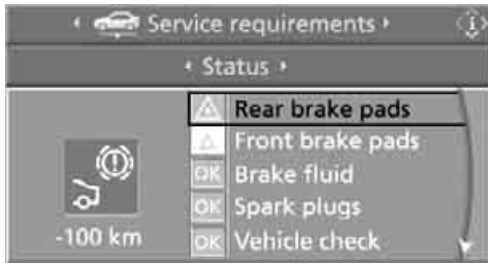

The BMW Maintenance System supports the preservation of the traffic and operating safety of your BMW. The service schedule also includes operations related to the vehicle's comfort and convenience features, such as replacement of the filters for the inside air. The objective is to optimize efforts with respect to minimal vehicle maintenance costs.

If and when you come to sell your BMW, a comprehensive record of servicing will prove a significant benefit.

CBS Condition Based Service

Sensors and special algorithms take the different driving conditions of your BMW into account. Condition Based Service uses this to determine the current and future service requirements. By letting you define a service and maintenance regimen that reflects your own individual requirements, the system builds the basis for trouble-free driving.

On the Control Display, you can have the remaining times or distances for selected maintenance tasks and any legally prescribed dates displayed, refer to page 77:

- ▷ Engine oil
- ▷ Brake pads: separately for front and rear
- ▷ Microfilter/activated-charcoal filter
- ▷ Brake fluid
- ▷ Spark plugs
- ▷ Vehicle check

- ▷ Legally mandated inspections depending on local regulations

Service data in the remote control

Your vehicle continuously stores service-requirement information in the remote control while you are driving. Your BMW Service Advisor can read out this data from the remote control unit, and propose an optimized maintenance approach. Whenever you take your car in for servicing you should therefore hand your BMW Service Advisor the remote control unit that you last used.

 Make sure that the date is always set correctly, refer to page 81; otherwise the effectiveness of Condition Based Service CBS is not assured. ◀

Service and Warranty Information Booklet for US models and Warranty and Service Guide Booklet for Canadian models

Please consult your Service and Warranty Information Booklet for US models and Warranty and Service Guide Booklet for Canadian models for additional information on service requirements.

 BMW recommends that you have service and repair operations performed at your BMW center.

Take the time to ensure that these service procedures are confirmed by entries in your vehicle's Service and Warranty Information Booklet for US models and Warranty and Service Guide Booklet for Canadian models. These entries verify that your vehicle has received the specified regular maintenance. ◀

Socket for On-Board Diagnosis OBD

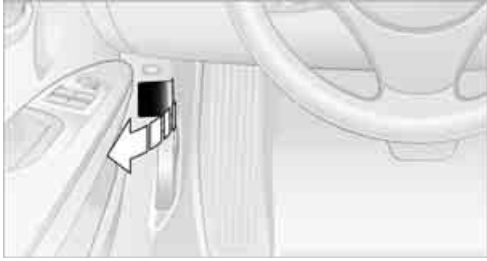

Primary components that make up exhaust emissions can be checked by a device via the OBD socket.

This socket is located on the driver's side to the left, on the bottom of the instrument panel underneath a cover.

Exhaust emission values

SERVICE
ENGINE
SOON



The warning lamps come on. The exhaust emission values have worsened. Have the car checked as soon as possible.



Canadian models display these warning lamps.

The lamps flash under certain conditions. This indicates excessive misfiring in the engine. If this happens, you should reduce your speed and visit your nearest BMW center as soon as possible. Severe engine misfiring can quickly lead to serious damage of emissions-related components, especially the catalytic converter.

Event data recorders

Your vehicle may be equipped with one or several measuring or diagnostic modules or a device for recording or sending certain vehicle data or information. In addition, if you have signed a subscription contract for BMW Assist, certain vehicle data may be transmitted or recorded in order to facilitate the corresponding services.

Care

Important information on the care and maintenance of your BMW is contained in the Caring for your vehicle brochure.

Replacing components

Onboard tool kit

Sedan



The onboard tool kit is stored in a compartment on the right-hand side of the cargo bay. Remove the cover.

Sports Wagon



The onboard tool kit is stored in a compartment on the left-hand side underneath the cargo bay floor panel.

Wiper blades

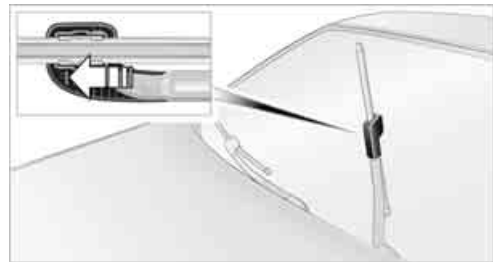

1. Fold up the wiper arm.
2. Remove the cover. To do so, press the hook on the bottom, see arrow.

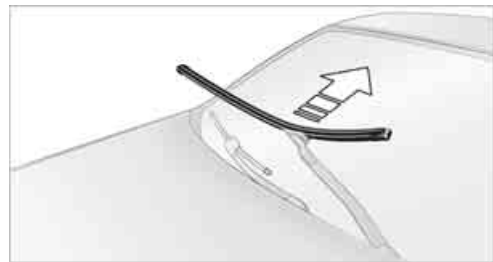

3. Fold the wiper blade upwards.
4. Remove the wiper blade in the direction of the windshield, see arrow.

! To avoid damage, make sure that the wiper arms are against the windshield before you open the engine compartment. ◀

Sports Wagon: changing rear wiper blade



1. Fold up the wiper arm.
2. Pull off the wiper blade, see arrow.
3. Insert the new wiper blade and press it on until it audibly engages.

Lamps and bulbs

Lamps and bulbs make an essential contribution to vehicle safety. They should, therefore, be handled carefully. BMW recommends having your BMW center perform any work that you do not feel competent to perform yourself or that is not described here.

 Never touch the glass of new bulbs with your bare fingers, as even minute amounts of contamination will burn into the bulb's surface and reduce its service life. Use a clean tissue, cloth or something similar, or hold the bulb by its base. ◀

You can obtain a selection of replacement bulbs at your BMW center.

 Only change bulbs while they are cool to the touch, otherwise you could suffer burns. ◀

 When working on electrical systems, always begin by switching off the consumer in question, otherwise short-circuits could result. To avoid possible injury or equipment damage when replacing bulbs, observe any instructions provided by the bulb manufacturer. ◀

For care and maintenance of the headlamps, please follow the instructions in the separate Caring for your vehicle brochure.

 If the routine for changing a particular bulb is not described here, please contact your BMW center or a workshop that works according to BMW repair procedures with correspondingly trained personnel. ◀

Light-emitting diodes LED

Light-emitting diodes installed behind translucent lenses serve as the light source for many of the controls and displays in your vehicle. These light-emitting diodes, which operate using a concept similar to that applied in conventional lasers, are officially designated as Class 1 light-emitting diodes.

 Do not remove the covers or expose the eyes directly to the unfiltered light source for several hours at a time, otherwise this could cause irritation to the retina. ◀

Xenon lamps

The service life of these bulbs is very long and the probability of a failure is very low, provided that they are not switched on and off an unusual number of times. If a xenon lamp fails nevertheless, switch on the fog lamps and continue the journey with great care, provided that local legislation does not prohibit this.

 Have any work on the xenon lamp system, including bulb replacements, performed only by a BMW center or a workshop that works according to BMW repair procedures with correspondingly trained personnel. Otherwise, if such work is carried out improperly, the high voltage in the system presents the danger of fatal injuries. ◀

Parking lamps, roadside parking lamps

In the event of a malfunction, please contact your BMW center or a workshop that works according to BMW repair procedures with correspondingly trained personnel.

Halogen lamps

H7 bulb, 55 watts

 Always wear gloves and eye protection; the atmosphere within the H7 bulb is

pressurized. Otherwise there is a risk of injury if the bulb is damaged. ◀

There are separate headlamp covers for low-beam headlamps and high-beam headlamps.

 Be careful when installing the covers, otherwise leaks could occur and cause damage to the headlamp system. ◀

 For checking and adjusting headlamp aim, please contact your BMW center. ◀

Access to the lamps

The high-beam headlamp can be accessed from the engine compartment, whereas the low-beam headlamp is accessed through a flap in the wheel well.

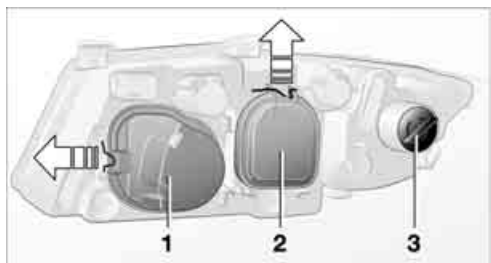

- 1 Cover for high-beam headlamp
- 2 Cover for low-beam headlamp
- 3 Turn signal bulb socket

To remove the covers:

1. Fold the respective wire bracket to the side, see arrows.
2. Flip open the cover and take it out of the guide.

Follow the same steps in reverse order to reattach the covers.

Access through the wheel well

Only for low-beam headlamps and turn signals:

1. Turn the wheel inwards.
2. Open the flap in the wheel well. To do so, turn the fastener counterclockwise using a coin, for example.



Changing low-beam and high-beam bulbs

1. Remove the relevant cover for the headlamp.
2. Disconnect the plug from the lamp.
3. Push the wire bracket to the side out of the mounting, arrow 1, and fold it down, arrow 2.

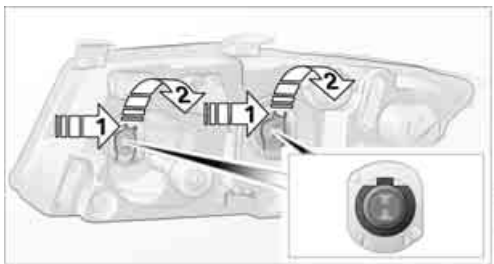

4. Remove the bulb.
5. Insert new bulb as shown in the detail of the illustration above.
6. Fold up the wire bracket and engage it.
7. Connect the plug.
8. Reattach the cover.

Parking lamps, roadside parking lamps

5-watt bulb, W5W

1. Remove the cover for the high-beam head-lamp.
2. Pull out the bulb socket, see arrow.

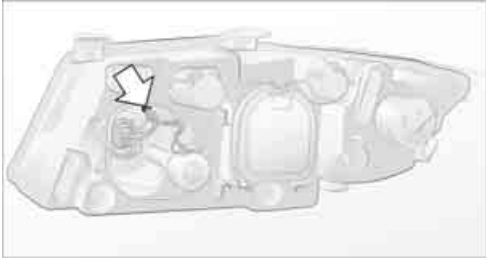

3. Remove and replace the bulb.
4. Insert bulb socket.
5. Reattach the cover.

Turn signals, front

21-watt bulb, PY21W
or PY21W Silver Vision

1. Open the flap in the wheel well, refer to Access through the wheel well on page 223.



2. Rotate turn signal bulb socket **1** to the left and remove.
3. Apply gentle pressure to the bulb while turning it to the left for removal and replacement.
4. Insert turn signal bulb socket **1**.
5. Attach the flap to the wheel well.

Tail lamps

Sedan

- ▷ Brake lamp in the luggage compartment lid: H21W bulb, 21 watts

- ▷ Other lamps: P21W bulb, 21 watts

The tail lamps are divided into two parts. One part is in the luggage compartment lid, the other is in the fender.

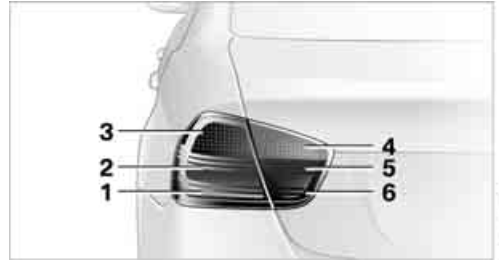

- 1 Brake lamp
- 2 Roadside parking lamp/tail lamp
- 3 Turn signal
- 4 Backup lamp
- 5 Tail lamp
- 6 Brake lamp

If one of the bulbs **2**, **5** or **6** malfunctions, please contact your BMW center or a workshop that works according to BMW repair procedures with correspondingly trained personnel.

Sports Wagon

- ▷ Brake lamp in the tailgate: H21W bulb, 21 watts
- ▷ Other lamps: P21W bulb, 21 watts

The tail lamps are divided into two parts. One part is in the tailgate, the other is in the fender.



- 1 Brake lamp
- 2 Roadside parking lamp/tail lamp

- 3 Turn signal
- 4 Backup lamp
- 5 Tail lamp
- 6 Brake lamp

Fender-mounted lamps

Sedan

1. Using a screwdriver, pry off the cover in the cargo bay or release the turn-lock fastener by turning it counterclockwise and remove the cover.
2. Loosen the bulb holder at the clip, see arrow, and pull out.

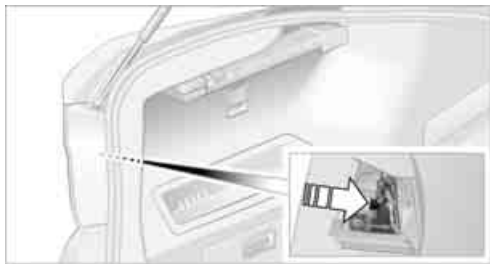

3. Apply gentle pressure to the bulb while turning it to the left for removal and replacement.
4. Re-engage the bulb holder so that it audibly clicks into place.
5. Reattach the cover in the cargo bay.

Sports Wagon

1. Left-hand lamps:
Open the flap on the left-hand side of the cargo bay.
Right-hand lamps:
Open the cargo bay floor panel. Turn the

screws on the cover, arrows **1**, 90° and take out the cover, arrow **2**.

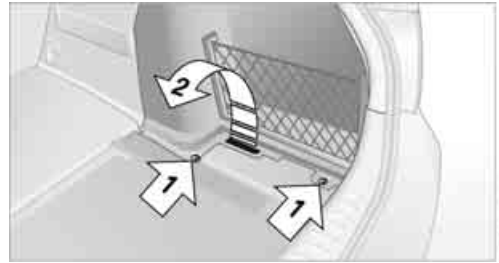

2. Loosen the bulb holder at the clip, see arrow, and pull out.

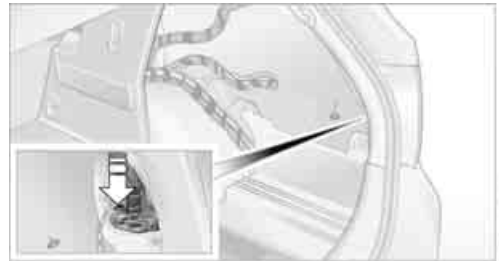

3. Apply gentle pressure to the bulb while turning it to the left for removal and replacement.
4. Re-engage the bulb holder so that it audibly clicks into place.
5. Reattach the cover in the cargo bay.

Lamps in the luggage compartment lid/ tailgate

Sedan

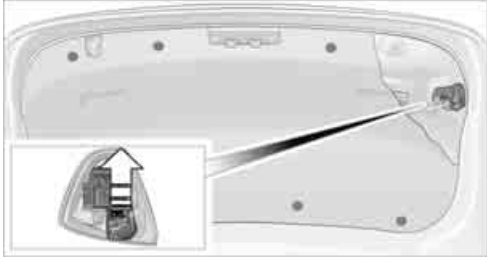

1. Pry out the plastic plugs in the trim of the luggage compartment lid using a screwdriver and remove the trim.
2. Unfasten the bulb holder at the clip, see arrow, and remove.
3. Apply gentle pressure to the bulb while turning it to the left for removal and replacement.
4. Re-engage the bulb holder so that it audibly clicks into place.
5. Reattach the trim of the luggage compartment lid.

Sports Wagon

1. Use a screwdriver to press out the cover at the clips, see arrows, and fold it downward.

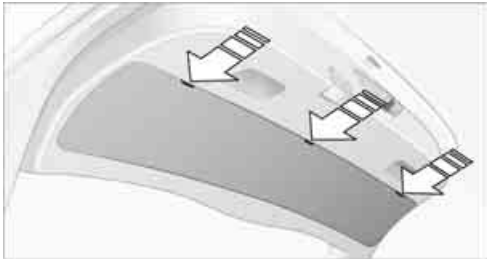

2. Fold away the foam insulating material.

3. Release the bulb holder at the clip, see arrow, and remove.

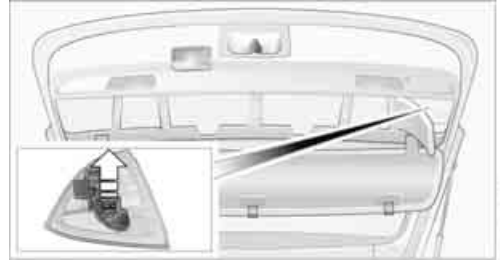

4. Apply gentle pressure to the bulb while turning it to the left for removal and replacement.
5. Re-engage the bulb holder so that it audibly clicks into place.
6. Reattach the trim of the tailgate.

License plate lamp

C5W bulb, 5 watts



1. Using a screwdriver, push the lamp to the right in the flap of the lamp housing.
2. Take out the lamp towards the left and change the bulb.
3. Insert the lamp.

Center brake lamp

This lamp uses LED technology for operation. In the event of a malfunction, please contact your BMW center or a workshop that works according to BMW repair procedures with correspondingly trained personnel.

Changing wheels

Your BMW is equipped with Run-Flat Tires as standard. This removes the need to change a wheel immediately in the event of a puncture.

For information on continuing to drive with a damaged tire, refer to Indication of a flat tire on page 91.

The symbol identifying Run-Flat Tires is a circle with the letters RSC on the sidewall, refer to Run-Flat Tires, page 212.

When mounting new tires or changing over from summer to winter tires and vice versa, mount Run-Flat Tires for your own safety. In the event of a flat, no spare wheel is available. Your BMW center will be glad to advise you. Refer also to New wheels and tires, page 212.

 The tools for changing wheels are available as optional accessories from your BMW center. ◀

Jack mounting points

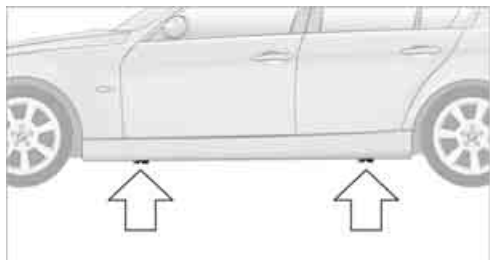

The jacking points are at the positions shown in the illustration.

Vehicle battery

Battery care

The battery is 100% maintenance-free, the electrolyte will last for the life of the battery when the vehicle is operated in a temperate climate. Your BMW center will be glad to advise in all matters concerning the battery.

Charging the battery

Only charge the battery in the vehicle via the terminals in the engine compartment with the engine off. Connections, refer to Jump starting on page 230.

Disposal



Have old batteries disposed of by your BMW center or hand them in to a recycling center. Maintain the battery in an upright position for transport and storage. Always secure the battery against tipping over during transport. ◀

Power failure

After a temporary power loss, the functioning of some equipment may be limited and require reinitialization. Individual settings may likewise have been lost and will have to be programmed:

- ▷ Time and date
These values must be updated, refer to page 80.
- ▷ Radio
In some cases, stations may have to be stored again, refer to page 162.
- ▷ Navigation system
Operability must be waited for, refer to page 130.
- ▷ Panorama glass roof
It may only be possible to raise the sunroof, if applicable. The system must be initialized. Please contact your BMW center.
- ▷ Seat and mirror memory
The positions must be stored again, refer to page 48.
- ▷ Inside rearview mirror with digital compass
The system must be calibrated, refer to page 109.

Fuses



Never attempt to repair a blown fuse and do not replace a defective fuse with a substitute of another color or amperage rating, otherwise this could lead to a circuit overload, ultimately resulting in a fire in the vehicle. ◀

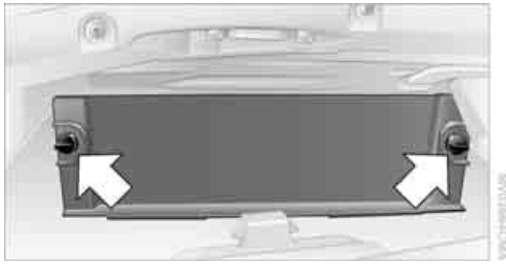

Open the cover in the glove compartment and remove it.

Spare fuses and a pair of plastic forceps are set in holders on the distributor box.

See the rear of the cover for information on fuse assignment.

Giving and receiving assistance

Emergency call*

Conditions for an emergency call:

- ▷ Equipment version with full mobile phone preparation package. This equipment makes it possible to initiate an emergency call even if no mobile phone is paired with the vehicle.
- ▷ BMW Assist is activated. Activating BMW Assist, refer to page 195.
- ▷ Radio readiness is on.
- ▷ The BMW Assist system is logged on to a mobile phone network.
- ▷ The emergency calling system is operable.

Once your service contract for BMW Assist expires, the BMW Assist system can be deactivated by a BMW center without you having to visit a workshop. Once the BMW Assist system has been deactivated, emergency calls are not possible. The BMW Assist system can be reactivated by a BMW center after a new contract has been signed.

Initiating an Emergency Request call

1. Briefly press the cover flap to open.



2. Press the button for at least 2 seconds.

The LED in the button lights up. As soon as the voice connection to the BMW Assist Response Center has been established, the LED flashes.

Once the BMW Assist Response Center has received your Emergency Request, the BMW Assist Response Center contacts you and takes further steps to help you.

If the circumstances allow this, remain in the vehicle until the connection has been established. You will then be able to provide a detailed description of the situation.

If the current location of your vehicle can be determined, it will be transmitted to the BMW Assist Response Center.

If the LED is flashing but the BMW Assist Response Center cannot be heard over the hands-free system, it is possible that the hands-free system is malfunctioning. You may still be heard by the BMW Assist Response Center, however.

Under certain conditions, an emergency call is automatically initiated immediately after a severe accident. This Automatic Collision Notification is not affected by the button being pressed.

 For technical reasons, the emergency calling services cannot be guaranteed for the most unfavorable conditions. ◀

Roadside Assistance

The BMW Group's Roadside Assistance service is there to assist you around the clock in the event of a breakdown, including on weekends and public holidays.

The phone numbers of the Roadside Assistance in your home country can be found in the Contact brochure.

In vehicles equipped with BMW Assist, you can establish contact with the BMW Group's Roadside Assistance for breakdown assistance directly via iDrive, refer to page 191.

First aid pouch*

Some of the articles contained in the first aid pouch have a limited service life. Therefore, check the expiration dates of the contents reg-

ularly and replace any items in good time, if necessary.

Sedan



The first aid pouch is located on the right-hand side of the cargo bay in a storage area.

Sports Wagon



The first aid pouch is located in the cargo bay behind the left-hand trim panel.

Warning triangle*

Sedan



The warning triangle is located on the left-hand side of the cargo bay. Press the tab to take it out.

Sports Wagon



The warning triangle is located behind the left-hand trim panel in the cargo bay. Press the tab to take it out.

Jump starting

If the car's own battery is flat, your BMW's engine can be started by connecting two jumper cables to another vehicle's battery. You can also use the same method to help start another vehicle. Only use jumper cables with fully-insulated clamp handles.

⚠ Do not touch any electrically live parts when the engine is running, or a fatal accident may occur. Carefully adhere to the following sequence, both to prevent damage to one or both vehicles, and to guard against possible personal injuries. ◀

Preparation

1. Check whether the battery of the other vehicle has a voltage of 12 volts and approximately the same capacitance in Ah. This information can be found on the battery.
2. Switch off the engine of the assisting vehicle.
3. Switch off any consumers in both vehicles.

⚠ There must not be any contact between the bodies of the two vehicles, otherwise there is a danger of shorting. ◀

Connecting jumper cables

 Connect the jumper cables in the correct order, so that no sparks which could cause injury occur. ◀

Your BMW has a jump-starting connection in the engine compartment which acts as the battery's positive terminal, refer also to the Engine compartment overview on page 215. The cap is marked with +.

1. Pull the cap of the BMW jump-starting connection up to remove.



2. Attach one terminal clamp of the plus/+ jumper cable to the positive terminal of the battery or a starting-aid terminal of the vehicle providing assistance.
3. Attach the second terminal clamp of the plus/+ jumper cable to the positive terminal of the battery or a starting-aid terminal of the vehicle to be started.
4. Attach one terminal clamp of the minus/- jumper cable to the negative terminal of the battery or to an engine or body ground of the assisting vehicle.
Your BMW has a special nut as body ground or negative pole.



5. Attach the second terminal clamp of the minus/- jumper cable to the negative termi-

nal of the battery or to the engine or body ground of the vehicle to be started.

Starting the engine

1. Start the engine of the donor vehicle and allow it to run for a few minutes at slightly increased idle speed.
2. Start the engine on the other vehicle in the usual way.
If the first start attempt is not successful, wait a few minutes before another attempt in order to allow the discharged battery to recharge.
3. Let the engines run for a few minutes.
4. Disconnect the jumper cables by reversing the above connecting sequence.

If necessary, have the battery checked and recharged.

 Never use spray fluids to start the engine. ◀

Tow-starting, towing away

 Observe the applicable laws and regulations for tow-starting and towing vehicles. ◀

 Do not transport any passengers other than the driver in a vehicle that is being towed. ◀

Using a tow fitting

The screw-in tow fitting must always be carried in the car. It can be screwed in at the front or rear of the BMW.

Sedan: it is stored in the onboard tool kit underneath the cover on the right-hand side of the cargo bay, refer to page 221.

Sports Wagon: it is stored in the onboard tool kit underneath the cover on the left-hand side of the cargo bay, refer to page 221.

 Use only the tow fitting provided with the vehicle and screw it all the way in. Use the tow fitting for towing on paved roads only. Avoid lateral loading of the tow fitting, e.g. do not lift

the vehicle by the tow fitting. Otherwise the tow fitting and the vehicle could be damaged. ◀

Access to screw thread

Rectangular cover panel in bumper:
Press on the upper edges of the cover panel.

Front

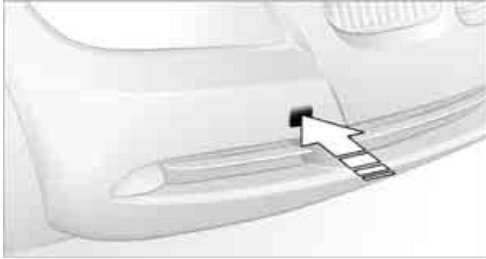

Rear

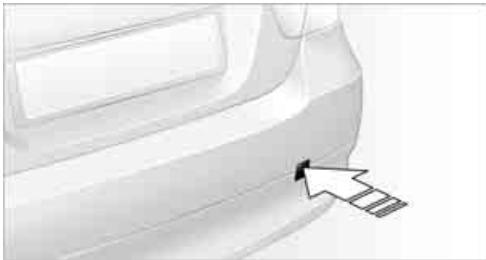

Being towed

⚠ Make sure that the ignition is switched on, refer to page 57, otherwise the low-beam headlamps, tail lamps, turn signal indicators and windshield wipers may be unavailable. If the electrical system fails, do not attempt to tow-start or tow away the car. The electric steering wheel lock cannot be disengaged and the car is not steerable. Jump starting, refer to page 230. Power steering assistance is not available when the engine is not running. Thus, braking and steering will require increased effort. ◀

Switch on the hazard warning flashers, depending on local regulations.

Manual transmission

Gearshift lever in idle position.

Automatic transmission

Selector lever in position N.

Changing selector lever positions, refer to page 60.

⚠ Do not exceed a towing speed of 45 mph or 70 km/h and a towing distance of 90 miles/150 km, otherwise the automatic transmission may be damaged. ◀

Towing methods

In some countries, it is illegal to tow your vehicle with a tow bar or tow rope on public highways.

Please familiarize yourself with the relevant towing regulations for the country in which you are driving.

With a tow bar

⚠ The towing vehicle must not be lighter than the towed vehicle, otherwise it may be impossible to maintain control. ◀

The tow fittings used should be on the same side on both vehicles. Should it prove impossible to avoid mounting the tow bar at an angle, please observe the following:

- ▷ Clearance and maneuvering capability will be sharply limited during cornering.
- ▷ The tow bar will generate lateral forces if it is attached offset.

⚠ Attach the tow bar to the tow fittings only, as attaching it to other parts of the vehicle could result in damage. ◀

With a tow rope

When starting off in the towing vehicle, make sure that the tow rope is taut.

⚠ To avoid jerking and the associated stresses on vehicle components when towing, always use nylon ropes or nylon straps. Attach the tow rope to the tow fittings only, as attaching it to other parts of the vehicle could result in damage. ◀

With a tow truck

Without xDrive

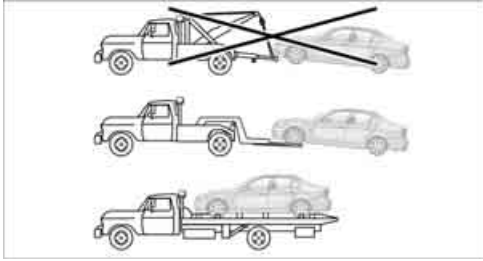

Have the BMW transported with a tow truck with a so-called lift bar or on a flat bed.

 Do not lift the vehicle by a tow fitting or body and chassis parts, otherwise damage may result. ◀

With xDrive

 Do not tow a BMW with xDrive with just the front or rear axle raised, otherwise the wheels could lock up and the transfer case could be damaged. ◀

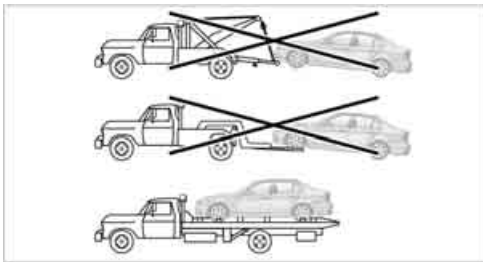

Have the BMW transported on a flatbed surface only.

Tow-starting

Avoid tow-starting the vehicle whenever possible; instead, jump-start the engine, refer to page 230. Vehicles with a catalytic converter should only be tow-started when the engine is cold, vehicles with an automatic transmission cannot be tow-started at all.

 If the electrical system fails, do not tow or tow-start the vehicle, as it would be impossible to release the electric steering-

wheel lock and the vehicle could not be steered. ◀

1. Switch on hazard warning flashers, comply with local regulations.
2. Switch on the ignition, refer to page 57.
3. Shift into 3rd gear.
4. Have the vehicle tow-started with the clutch depressed and slowly release the clutch. After the engine starts, immediately depress the clutch completely again.
5. Stop at a suitable location, remove the tow bar or rope and switch off the hazard warning flashers.
6. Have the vehicle checked.

 With xDrive: do not activate Hill Descent Control HDC when the vehicle is being tow-started, page 88. ◀



Reference

This chapter contains technical data, short commands for the voice command system and an index that will help you find information most quickly.

Technical data

Engine data

Sedan

		323i (Canada)	328i/xi	335i
Displacement	cu in/cm ³	152.4/2,497	182.8/2,996	181.8/2,979
Number of cylinders		6	6	6
Maximum power output	hp	200	230	300
at engine speed	rpm	6,000	6,500	5,800
Maximum torque	lb ft/Nm	180/244	200/270	300/407
at engine speed	rpm	4,000-5,000	2,750	1,400-5,000

Sports Wagon

		328i/xi
Displacement	cu in/cm ³	182.8/2,996
Number of cylinders		6
Maximum power output	hp	230
at engine speed	rpm	6,500
Maximum torque	lb ft/Nm	200/270
at engine speed	rpm	2,750

Dimensions

Sedan

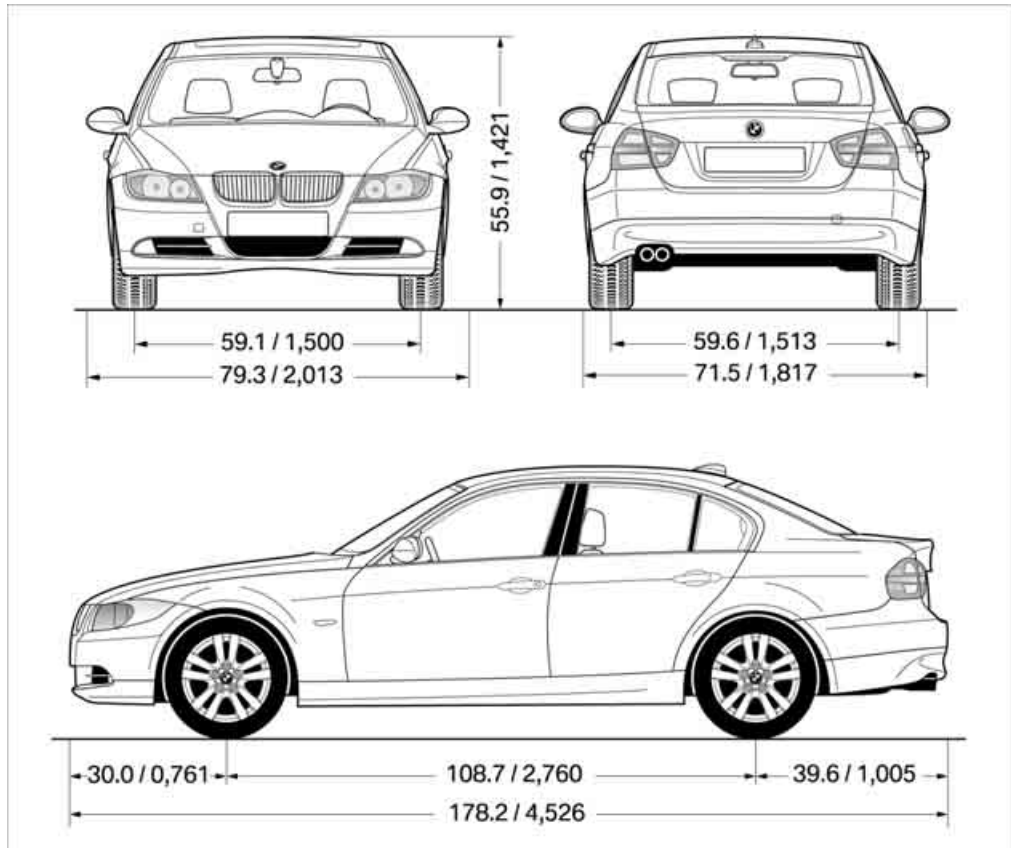

All dimensions given in inches/mm.

Smallest turning circle diam.: 36 ft 1 in/11.0 m, with xDrive: 38 ft 9 in/11.8 m.

Sports Wagon

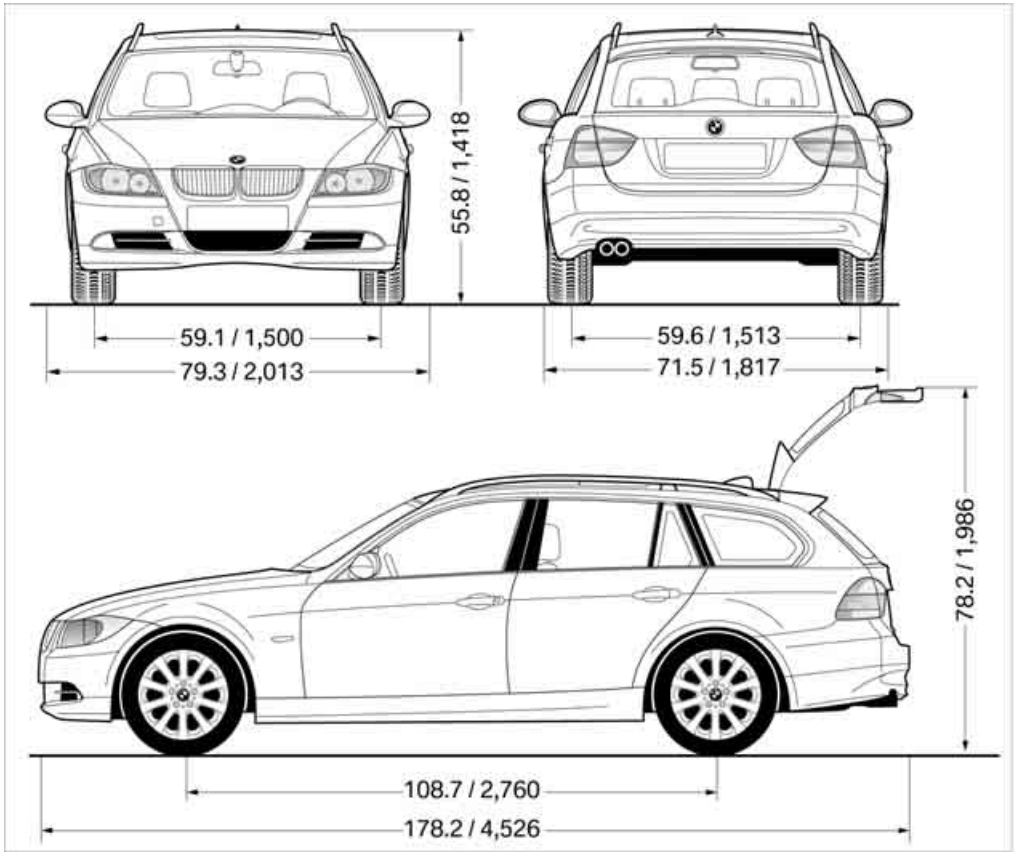

All dimensions given in inches/mm.

Smallest turning circle diam.: 36 ft 1 in/11.0 m, with xDrive: 38 ft 9 in/11.8 m.

Weights

Sedan

		323i (Canada)	328i	328xi
Curb weight				
▷ with manual transmission	lbs/kg	3,274/1,485	3,340/1,515	3,582/1,625
▷ with automatic transmission	lbs/kg	3,329/1,510	3,406/1,545	3,627/1,645
Approved gross weight				
▷ with manual transmission	lbs/kg	4,332/1,965	4,398/1,995	4,641/2,105
▷ with automatic transmission	lbs/kg	4,387/1,990	4,464/2,025	4,685/2,125
Load	lbs/kg	1,058/480	1,058/480	1,058/480
Approved front axle load	lbs/kg	2,083/945	2,116/960	2,293/1,040
Approved rear axle load	lbs/kg	2,403/1,090	2,458/1,115	2,502/1,135
Approved roof load capacity	lbs/kg	165/75	165/75	165/75
Cargo bay capacity	cu ft/l	16.2/460	16.2/460	16.2/460

			335i
Curb weight			
▷ with manual transmission	lbs/kg		3,593/1,630
▷ with automatic transmission	lbs/kg		3,605/1,635
Approved gross weight			
▷ with manual transmission	lbs/kg		4,652/2,110
▷ with automatic transmission	lbs/kg		4,663/2,115
Load	lbs/kg		1,058/480
Approved front axle load	lbs/kg		2,238/1,015
Approved rear axle load	lbs/kg		2,531/1,145
Approved roof load capacity	lbs/kg		165/75
Cargo bay capacity	cu ft/l		15.9/450

Never exceed either the approved axle loads or the gross vehicle weight.

Sports Wagon

		328i	328xi
Curb weight			
▷ with manual transmission	lbs/kg	3,527/1,600	3,770/1,710
▷ with automatic transmission	lbs/kg	3,593/1,630	3,814/1,730
Approved gross weight			
▷ with manual transmission	lbs/kg	4,630/2,100	4,872/2,210
▷ with automatic transmission	lbs/kg	4,696/2,130	4,916/2,230
Load	lbs/kg	1,102/500	1,102/500
Approved front axle load	lbs/kg	2,127/965	2,326/1,055
Approved rear axle load	lbs/kg	2,646/1,200	2,646/1,200
Approved roof load capacity	lbs/kg	165/75	165/75
Cargo bay capacity	cu ft/l	16.2/460 - 48.9/1,385	16.2/460 - 48.9/1,385

Never exceed either the approved axle loads or the gross vehicle weight.

Capacities

			Notes
Fuel tank	US gal/liters	approx. 16.1/61	Fuel grade: page 201
including reserve of	US gal/liters	approx. 2.1/8.0	
Window washer system			For more details: page 64
including headlamp washers	US quarts/liters	approx. 6.3/6.0	

Short commands for the voice command system*

With short commands you can carry out certain functions directly, regardless of which menu

item is selected. Here are the important short commands for the voice command system.

Assistance window

Function	Command
To call up assistance window 20	›Assistance window‹
To select display in the assistance window 20	›Assistance window map facing north‹, ›Assistance window map direction of travel‹, ›Assistance window arrow display‹, ›Assistance window perspective‹, ›Assistance window current position‹, ›Assistance window trip computer‹ or ›Assistance window onboard info‹
To change the scale in the assistance window 145	›Assistance window scale ... feet‹ or ›Assistance window scale ... miles‹

Communication

Function	Command
To open phone 181	›Phone‹
To dial phone number 181	›Dial number‹
To display phone book 182	›A to Z‹
To select from phone book 182	›Call ...‹ or ›Dial name‹
To display "Top 8" 182	›Top 8‹
Redialing 182	›Redial‹
To display "Received calls" 182	›Received calls‹
To display "Missed calls" 182	›Missed calls‹
To display "Bluetooth" 177	›Bluetooth‹
To call up BMW Assist 195	›BMW Assist‹
"BMW Service", to open services 191	›BMW Service‹
To open "BMW Contact" 184	›BMW Contact‹
To open "BMW Contact Numbers" 184	›BMW Contact numbers‹
To open "Roadside Assistance" 191	›Roadside Assistance‹

Navigation

Function	Command
To call up navigation 137	›Navigation‹
To display current position 150	›Current position‹
To open "Enter address" 131	›Enter address‹
To open "New destination" 131	›New destination‹
To display "Input map" 136	›Input map‹
To open "Information" 137	›Info menu‹
To display address book 138	›Address book‹ or ›From address book‹
To display destination list 138	›Destination list‹
To switch on destination guidance 143	›Start guidance‹
To switch off destination guidance 143	›Stop guidance‹
To display route criteria 141	›Route preference‹
To switch on voice instructions 146	›Navigation info on‹
To switch off voice instructions 146	›Navigation info off‹
To repeat voice instructions 146	›Repeat navigation info‹
To show arrow display 144	›Arrow display‹
To display map 145	›Map‹, ›Map facing north‹, ›Map direction of travel‹ or ›Perspective‹
To call up a route 133 , 147	›Route menu‹
To open "New route" 147	›New route‹
To change scale 145	›Scale ... miles‹ or ›Scale ... feet‹
To display towns/cities and streets along the route 146	›Route list‹

Onboard info

Function	Command
To open "Car Data" 74	›Car Data‹
To display onboard info 74	›Onboard info‹
To display trip computer 75	›Trip computer‹
To open speed limit 84	›Limit‹
To open stopwatch 84	›Stopwatch‹
To activate road-speed limit 84	›Limit on‹
To deactivate road-speed limit 84	›Limit off‹

Entertainment

Function	Command
Tone control 157	›Audio‹
To switch on radio 160	›Radio on‹, ›FM‹ or ›AM‹
To open "FM" 160	›FM menu‹
To open "AM" 160	›AM menu‹
To open "All stations" 160	›FM All stations‹
To select radio station 160	›Station‹ e.g. ›Station WNYC‹ or ›Choose station‹
To open "Presets" 160	›FM presets‹ or ›AM presets‹
To open "Manual" 161	›FM manual‹ or ›AM manual‹ or ›Choose frequency‹, ›Frequency ... Megahertz‹
To select preset radio station 162	›Preset ...‹ e.g. ›Preset 1‹
To open strongest radio station 161	›AM Autostore‹
To open "SAT" 164	›SAT radio menu‹
To switch on satellite radio 164	›SAT radio‹
To open "Presets" of satellite radio 165	›SAT radio presets‹
To open "All channels" of satellite radio 164	›SAT radio all channels‹
To open "Categories" of satellite radio 164	›SAT radio categories‹
To call up CD player 166	›CD menu‹
To switch on CD player 166	›CD‹
To call up CD changer 166	›CD changer menu‹
To switch on CD changer 166	›CD changer‹
To select a CD in the CD changer 166	›CD 1...6‹
To select track 167	›CD track ...‹
To select a CD and track in the CD changer 167	›CD 1...6 track ...‹
To select track 167	›Track ...‹
To call up DVD 166	›DVD player menu‹
To switch on DVD 166	›DVD player‹
To select music track on DVD 167	›DVD track ...‹
To start sound output for external audio device 173	›Audio Aux on‹

Climate

Function	Command
To open "Vent settings" 102	›Vent settings‹
To open "Automatic programs" 103	›Automatic programs‹

i menu

Function	Command
To open the i menu	›Settings menu‹
"Display off" 21	›Display off‹
To open "Info sources"	›Info sources‹
To open "Settings"	›Settings‹
To open "Door locks" 29, 32	›Door locks‹
To open "Steering wheel buttons" 51	›Steering wheel buttons‹
To open "Lighting" 62	›Lighting‹
To open "BMW Service" 191	›BMW Service‹
To open "Service requirements" 78, 190	›Service requirements‹
To open "Service" 78, 190	›Service‹
To display "Check Control messages" 82	›Check Control messages‹
To open "BMW Services" settings 195	›BMW Service settings‹
To set brightness of Control Display 85	›Brightness‹
To open "Units" 72	›Units‹
To open "Languages" 85, 146	›Languages‹
To open "Time" 80	›Time‹
To open "Date" 81	›Date‹
To open "PDC" 86	›PDC‹
To open "FTM" 90	›FTM‹

Everything from A-Z

Index

"..." Identifies Control Display texts used to select individual functions and refers you to the page where these texts can be found.

A

- ABS Antilock Brake System [87](#)
- ACC, refer to Active cruise control [66](#)
- Accident, refer to Initiating an Emergency Request call [229](#)
- Activated-charcoal filter for automatic climate control [105](#)
- "Activation time" [105](#)
- Active cruise control [66](#)
 - indicator lamps [68](#)
 - malfunction [69](#)
 - selecting distance [67](#)
 - sensor [69](#)
- Active steering [94](#)
 - warning lamp [94](#)
- Adaptive Head Light [99](#)
- "Add digits" on the mobile phone [183](#)
- Additives
 - coolant [217](#)
- "Address book" in navigation [139](#)
- Address for navigation
 - deleting [140](#)
 - entering [131](#), [134](#), [139](#)
 - selecting [139](#)
 - storing [139](#)
 - storing current position [139](#)
- "Add to destination list" [134](#), [136](#)
- Adjusting temperature inside the car, refer to Automatic climate control [102](#)
- Adjusting the thigh support [45](#)
- Adjusting the tone during audio operation, refer to Tone control [157](#)
- Adjustment in audio mode
 - front-to-rear [157](#)
 - right/left balance [157](#)
- Airbags [95](#)
 - indicator/warning lamp [96](#)
 - sitting safely [44](#)
- Air conditioning mode
 - automatic climate control [102](#)
 - ventilation [104](#)
- Air distribution
 - automatic [103](#)
 - individual [102](#)
- Air flow rate [103](#)
- Airing, refer to Ventilation [104](#)
- Air pressure, refer to Tire inflation pressure [202](#)
- Air recirculation, refer to Recirculated-air mode [103](#)
- "Air recirculation on / off" [52](#)
- Air supply
 - automatic climate control [102](#)
 - ventilation [104](#)
- Air vents [101](#)
- AKI, refer to Fuel specifications [201](#)
- Alarm system [35](#)
 - avoiding unintentional alarms [36](#)
 - interior motion sensor [36](#)
 - switching off an alarm [36](#)
 - tilt alarm sensor [36](#)
- "All channels" for satellite radio [164](#)
- All-season tires, refer to Winter tires [213](#)
- "All stations", displaying with the radio [160](#)
- All-wheel drive, refer to xDrive [88](#)
- "AM", waveband [156](#), [160](#)
- Ambient air, refer to Recirculated-air mode [103](#)
- Antenna for mobile phone [176](#)
- Antifreeze
 - coolant [217](#)
 - washer fluid [63](#)
- Anti-theft alarm system, refer to Alarm system [35](#)
- Anti-theft system [29](#)
- Approved axle loads, refer to Weights [239](#)
- Approved gross vehicle weight, refer to Weights [239](#)
- Armrest, refer to Center armrest [110](#)
- Arrival time, refer to Computer [74](#)
- Arrival time, refer to Starting destination guidance [143](#)
- "Arrow display" in navigation [144](#)
- Arrow view for navigation [144](#)
- Ashtray
 - front [112](#)
 - rear [112](#)
- Assistance systems, refer to Driving stability control systems [87](#)
- Assistance window [20](#)
 - refer to iDrive [20](#)
- AUC Automatic recirculated-air control [103](#)
- "Audio" [159](#)

Audio [156](#)
– controls [156](#)
– switching on/off [156](#)
– tone control [157](#)
– volume [157](#)
"Audio", refer to Tone control [157](#)
Audio device, external [111](#)
"Auto. headlamps" [98](#)
Automatic
– air distribution [103](#)
– air flow rate [103](#)
– cruise control [64](#), [66](#)
– headlamp control [97](#)
– service notification [192](#)
– storing of stations [161](#)
Automatic climate control [101](#)
– automatic air distribution [103](#)
– settings via iDrive [102](#)
Automatic curb monitor [50](#)
"Automatic programs" with automatic climate control [103](#)
Automatic recirculated-air control AUC [103](#)
Automatic station search [161](#)
Automatic transmission with Steptronic [59](#)
– interlock [59](#), [60](#)
– overriding selector lever lock [61](#)
– shiftlock, refer to Changing selector lever position [60](#)
– sport program [60](#)
– towing [231](#)
– tow-starting [231](#)
"Automatic ventilation" [105](#)
AUTO program for automatic climate control [103](#)
"Autostore"
– on the radio [162](#)
"AUX" [156](#), [173](#)
"AUX" for external audio device [173](#)
AUX-IN
– port [111](#)
AUX-In, refer to External audio device [173](#)

Average fuel consumption [74](#)
– setting the units [77](#)
Average speed [74](#)
"Avoid ferries" in navigation [142](#)
"Avoid highways" in navigation [141](#)
Avoid highways in navigation [141](#)
Avoiding unintentional alarms [36](#)
"Avoid tollroads" in navigation [142](#)
Axle loads, refer to Weights [239](#)
"A - Z" [182](#)

B

Backrest contour, refer to Lumbar support [46](#)
Backrests, refer to Seat adjustment [45](#)
Backrest width adjustment [46](#)
Back seats
– refer to Rear seats [47](#)
Backup lamps
– replacing bulbs [225](#), [226](#)
Backup lamps, refer to Tail lamps [224](#)
Balance, tone control [157](#)
Band-aids, refer to First-aid pouch [229](#)
Bar, refer to Towing methods [232](#)
Bass, tone control [157](#)
Bass sounds, refer to Tone control [157](#)
Bass sounds, refer to Treble and bass [157](#)
Battery [227](#)
– charging [227](#)
– disposal [38](#), [227](#)
– jump starting [230](#)
– remote control [28](#)
– temporary power failure [227](#)
Battery renewal
– remote control [38](#)
– remote control for vehicle [38](#)

Being towed [232](#)
Belts, refer to Safety belts [49](#)
Belt tensioner, refer to Safety belts [49](#)
Beverage holders, refer to Cup holders [111](#)
Blower, refer to Air flow rate [103](#)
Bluetooth, refer to separate Owner's Manual
"BMW Assist" [191](#), [192](#), [193](#)
BMW Assist
– activating [195](#)
– Concierge service [193](#)
– contacting BMW Customer Relations [193](#)
– Roadside Assistance [191](#)
– services offered [190](#)
– TeleService [192](#)
"BMW Contact" [184](#)
"BMW Contact Numbers" [184](#)
BMW Homepage [4](#)
BMW Maintenance System [219](#)
"BMW Services" [194](#), [195](#), [196](#)
BMW webpage [4](#)
Bottle holders, refer to Cup holders [111](#)
Bracket for telephone or mobile phone
– refer to Snap-in adapter in the center armrest storage compartment [110](#)
Brake assist, refer to Dynamic Brake Control DBC [87](#)
Brake fluid, refer to Service requirements [77](#)
Brake Force Display [94](#)
Brake lamps
– replacing bulbs [225](#), [226](#)
– two-stage [94](#)
Brake pads [122](#)
– breaking in [122](#)
Brake rotors [123](#)
– brakes [122](#)
– breaking in [122](#)

- Brakes
 - ABS [87](#)
 - BMW Maintenance System [219](#)
 - breaking in [122](#)
 - parking brake [59](#)
 - service requirements [77](#)
- Brakes, refer to Braking safely [123](#)
- Brake system [122](#)
 - BMW Maintenance System [219](#)
 - breaking in [122](#)
 - disc brakes [123](#)
- Breakdown services, refer to Roadside Assistance [229](#)
- Breaking in the clutch [122](#)
- Breaking in the differential, refer to Engine and differential [122](#)
- Break-in period [122](#)
- Brightness of the Control Display [85](#)
- "Brightness" on the control display [85](#)
- Bulb changing, refer to Lamps and bulbs [222](#)
- Burned fuel
 - refer to Average consumption [74](#)
- Button for starting the engine, refer to Start/stop button [57](#)
- Buttons on the steering wheel [11](#)

C

- California Proposition 65 warning [6](#)
- "Call" [183](#), [194](#)
- Call
 - accepting [181](#)
 - displaying accepted [183](#)
 - ending [182](#)
 - in absence [183](#)
 - starting [181](#)
- Calling
 - from phone book [182](#)
 - from Top 8 list [183](#)
 - redialing [183](#)
- Can holders, refer to Cup holders [111](#)
- Capacities [241](#)
- Capacity of the cargo bay [239](#)
- Car battery, refer to Vehicle battery [227](#)
- Car care, refer to Caring for your vehicle brochure
- Car-care products, refer to Caring for your vehicle brochure
- "Car Data" [74](#)
- Care, refer to Caring for your vehicle brochure
- Cargo, securing [125](#)
- Cargo bay [114](#)
 - capacity [239](#)
 - convenient access [37](#)
 - folding up the floor panel [117](#)
 - lamp, refer to Interior lamps [100](#)
 - opening from inside [33](#)
 - opening from outside [33](#)
 - partition net [115](#)
 - roll-up cover [114](#)
- Cargo bay lid, refer to Luggage compartment lid/tailgate [32](#)
- Cargo bay net, refer to Partition net [115](#)
- Cargo loading
 - securing cargo [125](#)
 - stowing cargo [125](#)
 - vehicle [124](#)
- Caring for artificial leather, refer to Caring for your vehicle brochure
- Caring for leather, refer to Caring for your vehicle brochure
- Caring for plastic, refer to Caring for your vehicle brochure
- Caring for the carpet, refer to Caring for your vehicle brochure
- Caring for the vehicle finish, refer to Caring for your vehicle brochure
- Car jack
 - jacking points [227](#)
- Car key, refer to Integrated key/remote control [28](#)
- Car phone [176](#)
 - installation location, refer to Center armrest [110](#)
 - refer to Mobile phone [176](#)
 - refer to separate Owner's Manual
- Car radio, refer to Radio [160](#)
- Car wash [124](#)
 - also refer to Caring for your vehicle brochure
 - with convenient access [38](#)
- Catalytic converter, refer to Hot exhaust system [122](#)
- "Categories" for satellite radio [164](#)
- CBS Condition Based Service [219](#)
- "CD" [156](#), [166](#)
- CD changer [166](#)
 - compressed audio files [166](#)
 - controls [156](#)
 - fast forward/reverse [170](#)
 - installation location [170](#)
 - playing a track [168](#)
 - random order [169](#)
 - repeating a track [169](#)
 - selecting a CD [166](#)
 - selecting a track [167](#)
 - switching on/off [156](#)
 - tone control [157](#)
 - volume [157](#)

- CD player [166](#)
 - compressed audio files [166](#)
 - controls [156](#)
 - fast forward/reverse [170](#)
 - playing a track [168](#)
 - random order [169](#)
 - repeating a track [169](#)
 - selecting a track [167](#)
 - switching on/off [156](#)
 - tone control [157](#)
 - volume [157](#)
- Center armrest [110](#)
- Center brake lamp
 - replacing bulbs [226](#)
- Center console, refer to
 - Around the center console [14](#)
- "Central locking" [30](#)
- Central locking
 - from inside [32](#)
 - from outside [29](#)
- Central locking system [29](#)
 - convenient access [36](#)
 - hotel function [34](#)
- Changes, technical, refer to
 - For your own safety [5](#)
- Changing bulbs, refer to
 - Lamps and bulbs [222](#)
- Changing the language on the
 - Control Display [85](#)
- Changing the measurement units on the
 - Control Display [77](#)
- Changing wheels [227](#)
- Chassis number, refer to
 - Engine compartment [215](#)
- Check Control [82](#)
- "Check Control messages" [84](#)
- Check Gas Cap [200](#)
- Child-restraint fixing system
 - LATCH [55](#)
- Child-restraint systems [53](#)
- Child-safety lock [56](#)
- Child seats, refer to
 - Transporting children safely [53](#)
- Chrome parts, care, refer to
 - Caring for your vehicle brochure
- Cigarette lighter, refer to
 - Lighter [112](#)
- Cleaning, refer to
 - Caring for your vehicle brochure
- Cleaning headlamps [63](#)
 - washer fluid [64](#)
- "Climate" [102](#)
- Clock [72](#)
 - 12h/24h mode [81](#)
 - setting time [80](#)
- Closing
 - from inside [32](#)
 - from outside [29](#)
- Clothes hooks [111](#)
- Cockpit [10](#)
- Cold start, refer to
 - Starting the engine [58](#)
- Combined instrument, refer to
 - Instrument cluster [12](#)
- Comfort access, refer to
 - Convenient access [36](#)
- Comfort area, refer to
 - Around the center console [14](#)
- "Communication" [181](#), [191](#), [192](#), [193](#)
- Compact disc, refer to
 - CD changer [166](#)
 - CD player [166](#)
- Compartment for remote control, refer to
 - Ignition lock [57](#)
- Compass [108](#)
- Computer [74](#)
 - displays on Control Display [74](#)
 - hour signal [81](#)
- Computer, refer to
 - iDrive [16](#)
- "Concert hall" for Tone control [158](#)
- "Concierge" [193](#)
- Concierge service [193](#)
- Condensation, refer to
 - When the vehicle is parked [124](#)
- Condition Based Service
 - CBS [219](#)
- Configuring settings, refer to
 - Personal Profile [28](#)
- Confirmation signals for locking/unlocking the vehicle [30](#)
- Connecting vacuum cleaner, refer to
 - Connecting electrical appliances [112](#)
- Consumption, refer to
 - Average consumption [74](#)
- Consumption display
 - average consumption [74](#)
- Consumption indicator
 - Energy Control [73](#)
- "Continue guidance to destination?" [144](#)
- Control Center, refer to
 - iDrive [16](#)
- Control Display
 - brightness [85](#)
 - changing the language [85](#)
 - switching off/on [21](#)
- Control Display, refer to
 - iDrive [16](#)
- Controller, refer to
 - iDrive [16](#)
- Controls and displays [10](#)
- Control unit, refer to
 - iDrive [16](#)
- Convenient access [36](#)
 - replacing the battery [38](#)
 - what to observe before entering a car wash [38](#)
- Convenient operation
 - glass sunroof [30](#)
 - glass sunroof with convenient access [37](#)
 - windows [30](#)
 - windows with convenient access [37](#)
- Coolant [217](#)
 - checking level [218](#)
- Coolant temperature [73](#)
- Cooling, maximum [103](#)
- Cooling fluid, refer to
 - Coolant [217](#)
- Cooling system, refer to
 - Coolant [217](#)
- Cornering lamps, refer to
 - Adaptive Head Light [99](#)
- Correct tires [212](#)

Courtesy lamps, refer to
 Interior lamps [100](#)
 Cross-hairs in navigation [136](#)
 Cruise control [64](#)
 – active [66](#)
 – malfunction [65](#)
 Cruising range [74](#)
 Cup holders [111](#)
 Curb weight, refer to
 Weights [239](#)
 Current fuel consumption,
 refer to Energy Control [73](#)
 "Current position" [150](#)
 Current position
 – displaying [150](#)
 – entering [139](#)
 – storing [139](#)
 "Customer
 Relations" [184](#), [193](#)

D

Dashboard, refer to
 Cockpit [10](#)
 Dashboard, refer to
 Instrument cluster [12](#)
 Dashboard lighting, refer to
 Instrument lighting [100](#)
 Data, technical [236](#)
 – dimensions [237](#)
 – engine [236](#)
 – weights [239](#)
 "Date" [82](#)
 Date
 – setting [81](#)
 – setting format [82](#)
 "Date format" [82](#)
 "Daytime running lamps" [98](#)
 Daytime running lamps [98](#)
 DBC Dynamic Brake
 Control [87](#)
 DCC, refer to Cruise
 control [64](#)
 "Deactivated" [49](#)
 Deactivating front passenger
 airbags [95](#)
 Deadlocking, refer to
 Locking [30](#)

Decommissioning the vehicle
 – refer to Caring for your
 vehicle brochure
 Defect
 – door lock [31](#)
 – fuel filler door [200](#)
 – glass sunroof [40](#)
 – panorama glass roof [42](#)
 Defogging windows [104](#)
 Defrost, windows [104](#)
 Defrosting windows [104](#)
 Defrosting windows and
 removing condensation
 – automatic climate
 control [104](#)
 Defrosting windshield, refer to
 Defrosting windows [104](#)
 Defrost position, refer to
 Defrosting windows [104](#)
 "Delete address book" in
 navigation [140](#)
 "Delete all numbers" on the
 mobile phone [184](#)
 "Delete data" in
 navigation [140](#)
 "Delete" for mobile
 phone [183](#)
 Destination address
 – deleting [140](#)
 – entering [131](#), [134](#)
 Destination for navigation
 – entry [131](#)
 – navigation list [138](#)
 – selecting from address
 book [139](#)
 – selecting using
 information [137](#)
 – storing [139](#)

Destination guidance [143](#)
 – canceling voice
 instructions [52](#)
 – changing specified
 route [141](#)
 – displaying route [144](#)
 – displaying routes [144](#)
 – distance and arrival [143](#)
 – starting [143](#)
 – terminating/continuing [143](#)
 – voice instructions [146](#)
 – volume of voice
 instructions [147](#)
 Destination list for navigation
 system [138](#)
 Destinations recently driven
 to [138](#)
 Detour, refer to Driving around
 a traffic jam [150](#)
 Detour during navigation [150](#)
 "Detour" in navigation [150](#)
 "Dial" for mobile phone [181](#)
 "Dial number" [182](#)
 Digital clock [72](#)
 Digital compass [108](#)
 Dimensions [237](#)
 Directional indicators, refer to
 Turn signals [61](#)
 Direction instructions, refer to
 Voice instructions [146](#)
 Directory for navigation, refer
 to Address book [138](#)
 Displacement, refer to Engine
 data [236](#)
 Display, refer to iDrive
 controls [16](#)
 Display lighting, refer to
 Instrument lighting [100](#)
 "Display off" [21](#)
 Displays
 – on the Control Display [16](#)
 Displays, refer to Instrument
 cluster [12](#)
 Displays and controls [10](#)
 Disposal
 – coolant [217](#)
 – remote control battery [38](#)
 – vehicle battery [227](#)

Distance control, refer to
Active cruise control [66](#)
Distance remaining to service,
refer to Service
requirements [77](#)
"Distance to dest." [75](#)
Distance warning, refer to
PDC Park Distance
Control [86](#)
Door key, refer to Remote
control with integrated
key [28](#)
Door lock [31](#)
"Door locks" [29](#), [31](#), [32](#), [78](#)
Doors, emergency
operation [31](#)
DOT Quality Grades [210](#)
Draft-free ventilation [104](#)
Drinks holders, refer to Cup
holders [111](#)
Drive-off assistance, refer to
Dynamic Stability Control
DSC [87](#)
Drive-off assistant [89](#)
Driving around a traffic
jam [150](#)
Driving lamps, refer to Parking
lamps/low beams [97](#)
Driving notes [122](#)
Driving off on hills, refer to
Drive-off assistant [89](#)
Driving route, refer to
Displaying route [144](#)
Driving stability control
systems [87](#)
Driving through water [123](#)
Driving tips, refer to Driving
notes [122](#)
Dry air, refer to Cooling
function [104](#)
DSC Dynamic Stability
Control [87](#)
DTC Dynamic Traction
Control [88](#)
– indicator/warning lamp [88](#)
DVD for navigation [130](#)
Dynamic Brake Control
DBC [87](#)

"Dynamic route" in
navigation [142](#)
Dynamic Stability Control
DSC
– indicator/warning lamp [88](#)
Dynamic Traction Control
DTC
– indicator/warning lamp [88](#)

E

EBV Electronic brake-force
distribution [87](#)
Eject button, refer to Buttons
on the CD player [156](#)
Electric
– seat adjustment [45](#)
Electrical malfunction
– door lock [31](#)
– driver's door [31](#)
– fuel filler door [200](#)
– glass sunroof [40](#)
– luggage compartment lid/
tailgate [33](#)
– panorama glass roof [42](#)
Electric seat adjustment [45](#)
Electric steering wheel
lock [57](#)
– with convenient access [37](#)
Electronic brake-force
distribution EBV [87](#)
Electronic oil level check [215](#)
Emergency actuation,
automatic transmission,
refer to Overriding selector
lever lock [61](#)
Emergency call [229](#)
Emergency operation
– fuel filler door, manual
release [200](#)
Emergency operation, refer to
Closing manually
– glass sunroof [40](#)
– panorama glass roof [42](#)
Emergency operation, refer to
Manual operation
– door lock [31](#)

Emergency release
– luggage compartment lid
from inside [34](#)
Emergency services, refer to
Roadside Assistance [229](#)
Emissions test, refer to
Service requirements [77](#)
"Enable services" [196](#)
"End call" [182](#)
Energy-conscious driving,
refer to Energy Control [73](#)
Energy Control [73](#)
Engine
– breaking in [122](#)
– data [236](#)
– overheated, refer to Coolant
temperature [73](#)
– speed [236](#)
– starting [58](#)
– starting, convenient
access [36](#)
– switching off [58](#)
Engine compartment [215](#)
Engine coolant, refer to
Coolant [217](#)
Engine oil
– adding [217](#)
– BMW Maintenance
System [219](#)
– capacity [241](#)
– checking level [215](#)
– intervals between changes,
refer to Service
requirements [77](#)
"Engine oil level" [216](#)
Engine output, refer to Engine
data [236](#)
Engine speed, refer to Engine
data [236](#)
Engine starting, refer to
Starting the engine [58](#)
"Enter address" [132](#)
Entering a destination
country [132](#)
Entering a house number or
intersection [133](#)
Entering a street [133](#)
Entering destination [132](#)
Entering the address [134](#)

Entering the intersection [133](#)
 "Entertainment" [156](#)
 Entry lamps, refer to Interior lamps [100](#)
 Environmentally friendly driving, refer to Energy Control [73](#)
 "Equalizer", refer to Tone control [158](#)
 Equalizer, refer to Tone control [158](#)
 Error messages, refer to Check Control [82](#)
 "ESN" [164](#)
 ESP Electronic Stability Program, refer to DSC Dynamic Stability Control [87](#)
 Event data recorders [220](#)
 Exhaust system, refer to Hot exhaust system [122](#)
 Expanding the cargo bay [115](#)
 Exterior mirrors [50](#)
 – adjusting [50](#)
 – automatic dimming feature [51](#)
 – automatic heating [50](#)
 – folding in and out [50](#)
 External audio device [111](#), [173](#)
 Eyes
 – for tow-starting and towing away [231](#)
 – for tying down loads [125](#)

F

Fader, tone control [157](#)
 Failure messages, refer to Check Control [82](#)
 Failure of an electrical consumer [227](#)
 False alarm
 – avoiding unintentional alarm [36](#)
 – switching off an alarm [36](#)
 Fastening safety belts, refer to Safety belts [49](#)

Fastest route for navigation [141](#)
 Fast forward
 – CD changer [170](#)
 – CD player [170](#)
 "Fast route" in navigation [141](#)
 Filter
 – refer to Microfilter/activated-charcoal filter for automatic climate control [105](#)
 Fine wood, refer to Caring for your vehicle brochure
 First aid pouch [229](#)
 Fixture for remote control, refer to Ignition lock [57](#)
 Flashlight, refer to Rechargeable flashlight [110](#)
 Flash when locking/unlocking [30](#)
 Flat
 – Run-Flat Tires [212](#)
 – Tire Pressure Monitor TPM [91](#)
 Flat tire
 – Tire Pressure Monitor [91](#)
 Flat Tire Monitor FTM [90](#)
 – indicating a flat tire [91](#)
 – indicator/warning lamp [91](#)
 – initializing the system [90](#)
 – malfunction [91](#)
 – snow chains [90](#), [213](#)
 – system limits [90](#)
 Flat tires, refer to Tire condition [211](#)
 Floor mats, carpets, refer to Caring for your vehicle brochure
 Fluid reservoir, refer to Washer fluid reservoir [64](#)
 "FM", waveband [156](#), [160](#)
 FM, waveband [160](#)
 Fog lamps [99](#)
 – indicator lamp [13](#), [99](#)
 Folding in the mirrors, before driving into a car wash [50](#)
 Folding rear seat backrest [115](#)
 Folding up the floor panel [117](#)
 Footbrake, refer to Braking safely [123](#)

Footwell lamps, refer to Interior lamps [100](#)
 For your own safety [5](#)
 Four-wheel drive, refer to xDrive [88](#)
 Front airbags [95](#)
 FTM, refer to Flat Tire Monitor [90](#)
 Fuel [201](#)
 – average consumption [74](#)
 – display [73](#)
 – high-quality brands [201](#)
 – quality [201](#)
 – specifications [201](#)
 – tank contents, refer to Capacities [241](#)
 Fuel clock, refer to Fuel gauge [73](#)
 Fuel display, refer to Fuel gauge [73](#)
 Fuel-efficient driving, refer to Energy Control [73](#)
 Fuel filler door [200](#)
 – releasing in the event of electrical malfunction [200](#)
 Fuses [227](#)

G

Garage door opener, refer to Integrated universal remote control [107](#)
 Gasoline, refer to Required fuel [201](#)
 Gasoline display, refer to Fuel gauge [73](#)
 Gasoline engine, checking oil level [215](#)
 Gear indicator
 – automatic transmission with Steptronic [59](#)
 Gearshift lever
 – automatic transmission with Steptronic [60](#)
 – manual transmission [59](#)
 Gearshifts
 – automatic transmission with Steptronic [60](#)
 – manual transmission [59](#)

General driving notes [122](#)
Glass sunroof, electric [39](#)
– closing after electrical malfunction [40](#)
– convenient operation [30, 31](#)
– initializing [40](#)
– opening, closing [40](#)
– operation with convenient access [37](#)
– pinch protection system [40](#)
– power failure [40](#)
– raising [39](#)
– remote control [30](#)
Glove compartment [110](#)
– rechargeable flashlight [110](#)
GPS navigation, refer to Navigation system [130](#)
Grills [101](#)
Gross vehicle weight, refer to Weights [239](#)

H

Halogen lamps
– replacing bulbs [222](#)
Handbrake, refer to Parking brake [59](#)
Hand lamp, refer to Rechargeable flashlight [110](#)
Hands-free system [14](#)
Hazard warning flashers [14](#)
HDC Hill Descent Control [88](#)
Head airbags [95](#)
Headlamp control, automatic [97](#)
Headlamp cover [222](#)
Headlamp flasher [61](#)
– indicator lamp [11, 13](#)
Headlamps
– care, refer to Caring for your vehicle brochure
– replacing bulbs [222](#)
Head restraints [46](#)
– front, removing [47](#)
– rear, removing [47](#)
– sitting safely [44](#)
Heated
– mirrors [50](#)
– rear window [104](#)
– seats [48](#)
Heating
– mirrors [50](#)
– rear window [104](#)
– residual heat [104](#)
– seats [48](#)
Heating and ventilation, refer to Climate [101](#)
Heating while at a standstill, refer to Using residual heat [104](#)
Heavy loads, refer to Stowing cargo [125](#)
Height, refer to Dimensions [237](#)
Height adjustment
– seats [45](#)
– steering wheel [51](#)
High beams [99](#)
– headlamp flasher [99](#)
– indicator lamp [13](#)
– replacing bulbs [222](#)
High water, refer to Driving through water [123](#)
Highways, refer to Route criteria [141](#)
Hill Descent Control HDC [88](#)
Hills [123](#)
Holders for cups [111](#)
Home address [140](#)
"Home address" in navigation [141](#)
Homepage BMW [4](#)
Hood [214](#)
Hooks for shopping bags [116](#)
Horn [10, 11](#)
Hotel function [34](#)
Hot exhaust system [122](#)
"Hour memo" [81](#)
"House number" in destination entry [134](#)
Hydraulic brake assist, refer to Dynamic Brake Control DBC [87](#)
Hydroplaning [123](#)

I
Ice warning, refer to Outside temperature warning [72](#)
ID3 tag, refer to Information about the track [168](#)
Identification marks
– Run-Flat Tires [212](#)
– tire coding [210](#)
iDrive [16](#)
– adjusting brightness [85](#)
– assistance window [20](#)
– automatic climate control [102](#)
– changing language [85](#)
– changing units of measure and display format [77](#)
– confirming selection or entry [19](#)
– controls [16](#)
– displays, menus [17](#)
– menu guidance [17](#)
– operating principle [16](#)
– overview [16](#)
– selecting a menu item [19](#)
– setting the date and time [80](#)
– start menu [17](#)
– status information [20](#)
– switching menu pages [19](#)
– symbols [18](#)
iDrive operating principle [16](#)
Ignition [57](#)
– switched off [57](#)
– switched on [57](#)
Ignition key, refer to Remote control with integrated key [28](#)
Ignition key position 1, refer to Radio readiness [57](#)
Ignition key position 2, refer to Ignition on [57](#)
Ignition lock [57](#)
i menu [18](#)
Indicator and warning lamps [13](#)
– Tire Pressure Monitor TPM [93](#)
Individual air distribution [102](#)

- Individually programmable buttons on steering wheel [51](#)
 - Inflation pressure, refer to Tire inflation pressure [202](#)
 - Inflation pressure monitoring, refer to Tire Pressure Monitor TPM [91](#)
 - Information
 - on another location [137](#)
 - on country [137](#)
 - on current position [137](#)
 - on destination location [137](#)
 - Information menu, refer to i menu [18](#)
 - "Information on destination" [138](#)
 - "Info sources" [78](#)
 - Initializing
 - active steering [94](#)
 - after power failure [227](#)
 - compass, refer to Calibrating [109](#)
 - Flat Tire Monitor FTM [90](#)
 - glass sunroof [40](#)
 - panorama glass roof [42](#)
 - "Input map" [136](#)
 - Installation location
 - CD changer [170](#)
 - drive for navigation DVD and audio CD [130](#)
 - telephone [110](#)
 - Instructions for navigation system, refer to Voice instructions [146](#)
 - Instrument cluster [12](#)
 - Instrument lighting [100](#)
 - Instrument panel, refer to Cockpit [10](#)
 - Integrated key [28](#)
 - Integrated universal remote control [107](#)
 - Interesting destination for navigation [137](#)
 - "Interim time" [85](#)
 - Interior lamps [100](#)
 - remote control [30](#)
 - Interior motion sensor [36](#)
 - Interior rearview mirror [51](#)
 - automatic dimming feature [51](#)
 - compass [108](#)
 - Interlock, refer to Disengaging the remote control [59](#)
 - Intermittent mode of the wipers [62](#)
- J**
- Jacking points [227](#)
 - Joystick, refer to iDrive [16](#)
 - Jumpering, refer to Jump starting [230](#)
 - Jump starting [230](#)
- K**
- Key, refer to Integrated key/remote control [28](#)
 - Keyless go, refer to Convenient access [36](#)
 - Keyless opening and closing, refer to Convenient access [36](#)
 - Key Memory, refer to Personal Profile [28](#)
 - Kick-down [60](#)
 - automatic transmission with Steptronic [60](#)
 - Knock control [201](#)
- L**
- Lamps
 - automatic headlamp control [97](#)
 - parking lamps/low beams [97](#)
 - Lamps and bulbs, replacing bulbs [222](#)
 - "Language / Units" [77](#)
 - "Language / Units" in navigation [146](#)
 - "Languages" in navigation [146](#)
 - "Languages" on the control display [85](#)
 - Lap-and-shoulder belt, refer to Safety belts [49](#)
 - Lashing eyes, refer to Securing cargo [125](#)
 - Last destinations, refer to Destination list [138](#)
 - "Last seat pos." [49](#)
 - LATCH child-restraint fixing system [55](#)
 - LED Light-emitting diodes [222](#)
 - Length, refer to Dimensions [237](#)
 - License plate lamp, replacing bulbs [226](#)
 - Light-emitting diodes LED [222](#)
 - Lighter [112](#)
 - connecting electrical appliances [112](#)
 - "Lighting" [62](#), [98](#)
 - Lighting
 - instruments [100](#)
 - lamps and bulbs [222](#)
 - vehicle, refer to Lamps [97](#)
 - Light-metal alloy wheels, care, refer to Caring for your vehicle brochure
 - Light switch [97](#)
 - "Limit" [84](#)
 - Limit, refer to Speed limit [84](#)
 - Load securing equipment, refer to Securing cargo [125](#)
 - Lock buttons, doors, refer to Locking [32](#)
 - Locking
 - adjusting confirmation signal [30](#)
 - from inside [32](#)
 - from outside [30](#)
 - without remote control, refer to Convenient access [36](#)
 - Locking and unlocking doors
 - confirmation signals [30](#)
 - from inside [32](#)
 - from outside [29](#)
 - Low beams [97](#)
 - automatic [97](#)
 - replacing bulbs [222](#)

Lower back support, refer to
Lumbar support [46](#)
Luggage compartment lid [32](#)
– convenient access [37](#)
– emergency operation, refer
to Opening manually [33](#)
– emergency release [34](#)
– locking or unlocking
separately [34](#)
– opening from inside [33](#)
– opening from outside [33](#)
– opening manually [33](#)
– remote control [30](#)
Luggage rack, refer to Roof-
mounted luggage rack [126](#)
Lumbar support [46](#)

M

M+S tires, refer to Winter
tires [213](#)
Maintenance, refer to Service
Booklet
Maintenance system [219](#)
Malfunction
– automatic transmission with
Steptronic [61](#)
– luggage compartment lid/
tailgate [33](#)
– tires [91](#)
Malfunction warnings, refer to
Check Control [82](#)
Manual mode, automatic
transmission with
Steptronic [60](#)
"Manual" on the radio [161](#)
Manual operation
– door lock [31](#)
– driver's door [31](#)
– fuel filler door [200](#)
– glass sunroof [40](#)
– luggage compartment lid/
tailgate [33](#)
– panorama glass roof [42](#)
– transmission lock, automatic
transmission [61](#)
Manual transmission [59](#)

Map
– changing scale [145](#)
– destination entry [136](#)
"Map direction of travel" [145](#)
"Map facing north" [145](#)
Master key, refer to Remote
control with integrated
key [28](#)
Maximum cooling [103](#)
Maximum speed
– with winter tires [213](#)
Measurements, refer to
Dimensions [237](#)
Memory, refer to Seat and
mirror memory [48](#)
MENU button [16](#)
Menus
– Control Display [17](#)
Menus, refer to iDrive [16](#)
Microfilter
– BMW Maintenance
System [219](#)
– for automatic climate
control [105](#)
Microfilter/activated-charcoal
filter
– BMW Maintenance
System [219](#)
Microphone
– telephone [14](#)
– voice input [14](#)
Mirror dimming feature [51](#)
Mirrors [50](#)
– automatic curb monitor [50](#)
– exterior mirrors [50](#)
– heating [50](#)
– interior rearview mirror [51](#)
– memory, refer to Seat and
mirror memory [48](#)
"Missed calls" [182](#)
Missed calls [183](#)

Mobile phone
– accepted calls [183](#)
– adjusting volume [180](#)
– calling [181](#)
– ending call [182](#)
– installation location, refer to
Center armrest [110](#)
– missed calls [183](#)
– operation via iDrive [181](#)
– redialing [183](#)
– refer to separate Owner's
Manual
– Top 8 [183](#)
– touch tone dialing [184](#)
Mobile phone, installation
location, refer to Center
armrest [110](#)
Mobile phone, refer to the
separate Owner's Manual
Mobile phone in the
vehicle [122](#)
Mobile phones, use inside the
car, refer to Mobile phone in
the vehicle [122](#)
Modifications, technical, refer
to For your own safety [5](#)
Monitor, refer to iDrive
controls [16](#)
Monitoring system for tire
pressures, refer to Flat Tire
Monitor [90](#)
"Monitor on / off" [52](#)
Most recent mobile phone
numbers [183](#)
MP3, refer to Compressed
audio files [166](#)
Multifunctional steering
wheel, refer to Buttons on
the steering wheel [11](#)
Multifunction switch
– refer to Turn signals/
headlamp flasher [61](#)
– refer to Wiper system [62](#)
Multimedia screen, refer to
iDrive [16](#)
Music tracks, refer to
Tracks [167](#)
"Mute on / off" [52](#)

N

"Navigation" [131](#)
 Navigation address
 – home address [140](#)
 Navigation announcements,
 refer to Switching voice
 instructions on/off [146](#)
 Navigation destination
 – manual entry [131](#), [134](#)
 – selecting via language [134](#)
 – selecting via map [136](#)
 Navigation drive, location [130](#)
 Navigation DVD [130](#)
 Navigation system [130](#)
 – address book [138](#)
 – changing a route [147](#)
 – destination entry [131](#)
 – destination guidance in
 assistance window [130](#)
 – destination list [138](#)
 – displaying current
 position [150](#)
 – entering a destination
 manually [131](#), [134](#)
 – last destinations [138](#)
 – navigation DVD [130](#)
 – opening [131](#)
 – route display [144](#)
 – route list [146](#)
 – searching for a special
 destination [137](#)
 – selecting destination using
 information [137](#)
 – selecting destination via
 map [136](#)
 – selecting route criteria [141](#)
 – starting destination
 guidance [143](#)
 – switching off, refer to
 Terminating/continuing
 destination guidance [143](#)
 – terminating/continuing
 destination guidance [143](#)
 – voice instructions [146](#)
 – volume adjustment [147](#)
 "Navigation voice
 instructions" via buttons on
 the steering wheel [52](#)

Neck support, refer to Head
 restraints [46](#)
 Nets, refer to Storage
 compartments [111](#)
 "New address" in
 navigation [139](#)
 "New data request" for BMW
 Assist [193](#)
 "New destination" [131](#), [136](#)
 "New route" [147](#)
 New tires [212](#)
 "Next entertainment
 source" [52](#)
 North-facing map [145](#)
 Nozzles [101](#)
 Number of cylinders, refer to
 Engine data [236](#)
 Nylon rope, refer to Tow
 rope [232](#)

O

OBD socket, refer to Socket
 for On-Board Diagnosis [220](#)
 Octane ratings, refer to Fuel
 specifications [201](#)
 Odometer [72](#)
 Oil, refer to Engine oil [215](#)
 Oil consumption [215](#)
 Oil level [215](#)
 Old batteries, refer to
 Disposal [227](#)
 "On a new destination" in
 navigation [137](#)
 "Onboard info" [75](#)
 Onboard tool kit [221](#)
 "On destination" [137](#)
 "On location" [137](#)
 Opening and closing
 – convenient access [36](#)
 – from inside [32](#)
 – from outside [29](#)
 – using the door lock [31](#)
 – via the remote control [29](#)

Operation by voice for mobile
 phone [185](#)
 – adjusting volume [187](#)
 – canceling [186](#)
 – correcting phone
 number [187](#)
 – dialing phone number [187](#)
 – placing a call [187](#)
 – redialing [188](#)
 – voice commands [185](#)
 – voice phone book [187](#)
 "Options" [194](#)
 Orientation menu, refer to
 Start menu [17](#)
 Outlets
 – refer to Ventilation [104](#)
 Output, refer to Engine
 data [236](#)
 Outside-air mode
 – automatic climate
 control [103](#)
 Outside-temperature
 display [72](#)
 – changing units of
 measure [77](#)
 – in computer [77](#)
 Outside temperature
 warning [72](#)
 Overheated engine, refer to
 Coolant temperature [73](#)
 Overriding selector lever
 lock [61](#)

P

Panorama glass roof [41](#)
 – closing after electrical
 malfunction [42](#)
 – comfort position [41](#)
 – convenient operation [30](#)
 – initializing [42](#)
 – opening, closing [41](#)
 – pinch protection system [42](#)
 – power failure [42](#)
 – raising [41](#)
 – remote control [30](#)
 Park assistant, refer to Park
 Distance Control [86](#)
 "Parked car operation" [105](#)

"Parked car ventilation" [105](#)
Parked car ventilation [105](#)
Parked car ventilation/heating
– activating switch-on times [106](#)
– preselecting switch-on times [105](#)
– switching on and off directly [105](#)
Parking
– vehicle [58](#)
Parking aid, refer to PDC Park Distance Control [86](#)
Parking brake [59](#)
– indicator lamp [59](#)
Parking lamps [97](#)
Parking lamps/low beams [97](#)
– replacing bulbs [223](#)
Partition net [115](#)
Passenger-side mirror tilt function [50](#)
"Pathway lighting" [98](#)
Pathway lighting [98](#)
"PDC" [86](#)
PDC Park Distance Control [86](#)
Personal Profile [28](#)
"Perspective" [145](#)
Phone book [181](#)
Phone numbers
– deleting from phone book [183](#)
– dialing [181](#)
– most recent numbers [183](#)
– selecting in phone book [183](#)
– Top 8 [183](#)
Pinch protection system
– glass sunroof, electric [40](#)
– panorama glass roof [42](#)
– windows [39](#)
Placing a call, refer to telephone owner's manual
"Play" for audio mode [167](#)
"Play" for satellite radio [165](#)
Pollen
– refer to Microfilter/activated-charcoal filter for automatic climate control [105](#)

Position
– displaying [150](#)
– saving, refer to Storing current position [139](#)
Power failure [227](#)
Power seats [45](#)
Power windows [38](#)
– safety switch [39](#)
Power windows, refer to Windows [38](#)
Preselecting the switch-on times for parked car ventilation/heating [105](#)
"Presets" displaying with the radio [160](#)
"Presets" for satellite radio [164](#)
Pressure, tires [202](#)
Pressure monitoring, tires [90](#)
– Flat Tire Monitor [90](#)
Pressure monitoring of tires, refer to Tire Pressure Monitor TPM [91](#)
"Profile" [196](#)
Programmable buttons on the steering wheel [11](#)
Protection function, refer to Pinch protection system
– glass sunroof, electric [40](#)
– panorama glass sunroof [42](#)
– windows [39](#)
Providing medical assistance, refer to First aid pouch [229](#)
Puncture
– Flat Tire Monitor [90](#)

R

Radio
– autostore [161](#)
– controls [156](#)
– listening to stations [160](#)
– sampling stations [161](#)
– satellite radio [163](#)
– selecting a waveband [156](#), [160](#)
– selecting the frequency manually [161](#)
– station search [161](#)
– stations with best reception [161](#)
– storing stations [162](#)
– switching on/off [156](#)
– tone control [157](#)
– volume [157](#)
Radio position, refer to Radio readiness [57](#)
Radio readiness [57](#)
– switched off [57](#)
– switched on [57](#)
Radio-remote key, refer to Remote control with integrated key [28](#)
Rain sensor [62](#)
"Random", refer to Random play [169](#)
"Random all" for audio mode [170](#)
"Random directory" for audio mode [170](#)
Random play [169](#)
"RDS" Radio Data System [163](#)
Reading lamps [100](#)
Rear lamps, refer to Tail lamps [224](#)
– replacing bulbs [225](#), [226](#)
Rear seat backrest, folding [115](#)
Rear seats
– adjusting head restraints [47](#)
– folding [115](#)
– folding head restraint down and up [47](#)
– folding the backrests [115](#)

- Rear turn signals
 - replacing bulbs [225](#)
- Rear ventilation [105](#)
- Rearview mirror, refer to Mirrors [50](#)
- Rear window
 - cleaning [63](#)
 - opening [35](#)
- Rear window blind, refer to Roller sun blinds [110](#)
- Rear window defroster [104](#)
- Rear window safety switch [39](#)
- Rear window wiper [63](#)
 - changing rear wiper blade [222](#)
- "Received calls" [182](#)
- Receiving level of mobile phone, refer to Status information [20](#)
- Rechargeable flashlight [110](#)
- Recirculated-air mode [103](#)
- Recirculation of air, refer to Recirculated-air mode [103](#)
- Reclining seat, refer to Backrest [45](#)
- Recording times, refer to Stopwatch [84](#)
- "Redial" on the mobile phone [182](#)
- Refueling [200](#)
- Releasing
 - hood [214](#)
- Remaining distance, refer to Cruising range [74](#)
- Remote control [28](#)
 - battery renewal [38](#)
 - convenient access [36](#)
 - garage door opener [107](#)
 - luggage compartment lid [30](#)
 - malfunction [31](#), [38](#)
 - removing from the ignition lock [57](#)
 - service data [219](#)
 - tailgate [30](#)
- "Repeat directory" for audio mode [169](#)
- "Repeat" for audio mode [169](#)
- "Repeat track" for audio mode [169](#)
- Replacement remote control [28](#)
- Replacing bulbs, refer to Lamps and bulbs [222](#)
- Replacing tires [212](#)
- Replacing tires, refer to New wheels and tires [212](#)
- Reporting safety defects [6](#)
- Reserve warning, refer to Fuel gauge [73](#)
- "Reset" [90](#), [92](#)
- Reset, refer to Resetting tone settings [159](#)
- "Reset" for stopwatch [85](#)
- "Reset" for tone settings [159](#)
- Residual heat [104](#)
- Restraint systems
 - for children [53](#)
 - refer to Safety belts [49](#)
- Reverse
 - CD changer [170](#)
 - CD player [170](#)
- Reverse gear
 - automatic transmission with Steptronic [60](#)
 - manual transmission [59](#)
- Road map [145](#)
- "Roadside Assistance" [191](#)
- Roadside Assistance [191](#), [229](#)
- Roadside parking lamps [99](#)
 - replacing bulbs [223](#)
- Roadworthiness test, refer to Service requirements [77](#)
- Roller blind
 - sun blinds [110](#)
- Roof load capacity [239](#)
- Roof-mounted luggage rack [126](#)
- Rope, refer to Tow-starting, towing away [232](#)
- Rotary/pushbutton, refer to iDrive [16](#)
- Route [141](#)
 - changing [147](#)
 - display [144](#)
 - displaying arrow view [144](#)
 - displaying maps [145](#)
 - displaying streets and towns/cities [146](#)
 - displaying town [146](#)
 - list [146](#)
 - selecting [141](#)
 - selecting criteria [141](#)
- RSC Runflat System Component, refer to Run-Flat Tires [212](#)
- Rubber parts, refer to Caring for your vehicle brochure
- Runflat System Component RSC, refer to Run-Flat Tires [212](#)
- Run-Flat Tires [212](#)
 - continuing driving with a damaged tire [91](#)
 - flat tire [91](#)
 - Flat Tire Monitor [91](#)
 - new tires [212](#)
 - replacing [212](#)
 - tire inflation pressure [202](#)
 - winter tires [213](#)

S

- Safety-belt height adjustment [49](#)
- Safety belts [49](#)
 - damage [50](#)
 - indicator/warning lamp [49](#)
 - reminder [49](#)
 - sitting safely [44](#)
- Safety belts, care, refer to Caring for your vehicle brochure

- Safety systems
 - airbags [95](#)
 - Antilock Brake System ABS [87](#)
 - brake system [87](#)
 - driving stability control systems [87](#)
 - Dynamic Stability Control DSC [87](#)
 - safety belts [49](#)
- Safety tires, refer to Run-Flat Tires [212](#)
- "SAT" [156](#), [163](#)
- Satellite radio [163](#)
 - displaying additional information [165](#)
 - enabling [163](#)
 - selecting channel [164](#)
 - storing channel [164](#)
- "Scan"
 - sampling radio stations [161](#)
 - sampling tracks on CD [168](#)
- Scan
 - CD changer [168](#)
 - CD player [168](#)
 - radio [161](#)
- "Scan all" for audio mode [168](#)
- "Scan directory" for audio mode [168](#)
- Screen, refer to iDrive controls [16](#)
- Screw thread for tow fitting [232](#)
- SDARS, refer to Satellite radio [163](#)
- Seat adjustment
 - electric [45](#)
 - mechanical [45](#)
- Seat and mirror memory [48](#)
- Seat backrests in the rear
 - folding [113](#)
- Seat belt reminder, refer to 'Fasten safety belts' reminder [49](#)
- Seat heating [48](#)
- Seats [45](#)
 - adjusting electrically [45](#)
 - adjusting the seats [45](#)
 - heating [48](#)
 - memory, refer to Seat and mirror memory [48](#)
 - saving a setting, refer to Seat and mirror memory [48](#)
 - sitting safely [44](#)
- Securing cargo [118](#)
- Securing the vehicle
 - from inside [32](#)
 - from outside [29](#)
- "Select as destination" [137](#), [194](#)
- "Select current speed" [84](#)
- Selecting a country for navigation [132](#)
- Selecting an audio source [156](#)
- Selecting distance for active cruise control [67](#)
- Selecting menu items [19](#)
- Selecting new scale for navigation [145](#)
- Selecting the frequency manually [161](#)
- Selector lever
 - automatic transmission with Steptronic [60](#)
- Selector lever interlock, refer to Changing selector lever position, Shiftlock [60](#)
- Selector lever positions
 - automatic transmission with Steptronic [60](#)
- "Service" [78](#), [192](#), [216](#)
- Service, refer to Roadside Assistance [229](#)
- Service car, refer to Roadside Assistance [229](#)
- Service data in the remote control [219](#)
- Service Interval Display, refer to Condition Based Service CBS [219](#)
- "Service notification" [192](#)
- "Service Request" [184](#), [192](#)
- Service requirement display, refer to Condition Based Service CBS [219](#)
- "Service requirements" [78](#), [192](#), [216](#)
- Service requirements [77](#)
- "Service Status" [195](#)
- "Set date" [82](#)
- "Set time" [81](#)
- "Settings" [194](#), [195](#), [196](#)
- Settings
 - changing settings on the Control Display [85](#)
 - clock, 12h/24h mode [81](#)
 - date format [82](#)
 - language [85](#)
- Settings and information [76](#)
- "Settings" for unlocking [29](#)
- Settings menu, refer to i menu [17](#)
- Setting times, refer to Preselecting switch-on times [105](#)
- Shifting gears
 - automatic transmission with Steptronic [60](#)
 - manual transmission [59](#)
- Shiftlock
 - automatic transmission, refer to Changing selector lever positions [60](#)
- Short commands for the voice command system [242](#)
- Shortest route in navigation, refer to Selecting route [141](#)
- "Short route" in navigation [141](#)
- "Show current position" [137](#)
- "Show destination position" [137](#)
- Shuffled, refer to Random
 - CD changer [169](#)
 - CD player [169](#)
- Side airbags [95](#)
- Side window blind, refer to Roller sun blinds [110](#)
- Side windows, refer to Windows [38](#)

- Signal horn, refer to Horn [10](#), [11](#)
- Sitting safely [44](#)
 - with airbags [44](#)
 - with head restraint [44](#)
 - with safety belts [44](#)
- Ski bag [117](#)
- Sliding/tilt sunroof
 - refer to Panorama glass roof [41](#)
- Sliding/tilt sunroof, refer to Glass sunroof, electric [39](#)
- Slot for remote control [57](#)
- Smokers' package, refer to Ashtray [112](#)
- Snap-in adapter, refer to Center armrest storage compartment [110](#)
- Socket, On-Board Diagnosis OBD [220](#)
- Socket, refer to Connecting electrical appliances [112](#)
- Song search, refer to Playing a track [168](#)
- SOS, refer to Initiating an Emergency Request call [229](#)
- Sound output for entertainment on/off [156](#)
- Spare fuses [227](#)
- Spare fuses, refer to Fuses [227](#)
- Spark plugs, refer to Service requirements [77](#)
- Speaking, refer to Voice instructions for navigation system [146](#)
- Speed
 - Run-Flat Tires [91](#)
 - with winter tires [213](#)
- Speed-dependent volume control [157](#)
- Speed limit [84](#)
- Speed limit warning, refer to Speed limit [84](#)
- Speedometer [12](#)
- "Speed volume", refer to Tone control [158](#)
- Split rear seat backrest, refer to Expanding the cargo bay [115](#)
- Spray nozzles, refer to Cleaning windshield and headlamps [63](#)
- Stability control, refer to Driving stability control systems [87](#)
- Start/stop button [57](#)
 - starting the engine [58](#)
 - switching off the engine [58](#)
- "Start guidance" [134](#), [138](#), [140](#), [143](#)
- Starting, refer to Starting the engine [58](#)
- Starting assistance, refer to Jump starting [230](#)
- Starting difficulties
 - jump starting [230](#)
 - temperature [58](#)
- Starting the engine
 - start/stop button [57](#)
- Start menu [17](#)
- "Start service" [191](#)
- "State / Province" in destination entry [132](#)
- Station
 - refer to Radio [160](#)
- "Status" [78](#)
- Status of this Owner's Manual at time of printing [5](#)
- Steering wheel [51](#)
 - adjustment [51](#)
 - arrested, refer to Electric steering wheel lock [51](#)
 - buttons on steering wheel [11](#)
 - freely programmable buttons [51](#)
 - lock [57](#)
 - lock, refer to Electric steering wheel lock [51](#)
 - locking with convenient access [37](#)
 - programmable buttons [51](#)
- "Steering wheel buttons" [52](#)
- Steering with variable ratio, refer to Active steering [94](#)
- Steptronic, refer to Automatic transmission with Steptronic [59](#)
- "Stopwatch" [85](#)
- Stopwatch [84](#)
- Storage compartments [111](#)
- Storage nets [116](#)
- "Store" for satellite radio [165](#)
- "Store in address book" in navigation [139](#)
- "Store" on the radio [162](#)
- Storing current position [139](#)
- Storing radio stations [162](#)
- Storing seat positions, refer to Seat and mirror memory [48](#)
- Storing tires [213](#)
- Stowage, refer to Storage compartments [111](#)
- "Street" in destination entry [133](#)
- Summer tires, refer to Wheels and tires [202](#)
- Sun blinds [110](#)
- Surface ice, refer to Outside temperature warning [72](#)
- "Surround Settings", refer to Tone control [158](#)
- Switches, refer to Cockpit [10](#)
- Switching off
 - engine [58](#)
- Switching off the engine
 - start/stop button [57](#)
- Switching on
 - audio [156](#)
 - CD changer [156](#)
 - CD player [156](#)
 - radio [156](#)
- Switching on the hour signal [81](#)
- Switching the cooling function on and off [104](#)
- Symbols [4](#)
 - status information [20](#)
 - traffic info for navigation system [147](#)

T

Tachometer [72](#)

- Tailgate
 - convenient access [37](#)
 - emergency operation, refer to [Opening manually 33](#)
 - opening from inside [33](#)
 - opening from outside [33](#)
 - opening manually [33](#)
 - remote control [30](#)
- Tail lamps [224](#)
 - replacing bulbs [225, 226](#)
- Tank contents, refer to [Capacities 241](#)
- Technical data [236](#)
 - capacities [241](#)
 - dimensions [237](#)
- Technical modifications, refer to [For your own safety 5](#)
- Telematics, refer to [TeleService, BMW Assist 190](#)
- Telephone
 - installation location, refer to [Center armrest 110](#)
 - refer to separate [Owner's Manual](#)
- Telephone, refer to [Mobile phone 176](#)
- "Telephone list" [52](#)
- TeleService [192](#)
- Temperature
 - automatic climate control [102](#)
 - changing unit of measure [77](#)
 - coolant, refer to [Coolant temperature 73](#)
- Temperature display
 - outside temperature [72](#)
 - outside temperature warning [72](#)
 - setting the units [77](#)
- Tempomat, refer to [Cruise control 64](#)
- Tensioning straps, refer to [Securing cargo 125](#)
- "Terminate services" [195](#)
- "Text language" [85](#)
- "Theater" for Tone control [158](#)
- The individual vehicle [5](#)
- Third brake lamp, refer to [Center brake lamp 226](#)
- Through-loading system [113](#)
- Through-loading system, refer to [Expanding the cargo bay 115](#)
- "TI" [148](#)
- Tilt alarm sensor [36](#)
- Tilt function, passenger-side mirror [50](#)
- "Time" [81](#)
- "Time / Date" [80, 81, 82](#)
- "Time format" [81](#)
- Timer, refer to [Preselecting switch-on times 105](#)
- "Timer 1" for parked car ventilation/heating [106](#)
- "Timer 2" for parked car ventilation/heating [106](#)
- Tire inflation pressure [202](#)
 - loss [91, 92](#)
- Tire pressure monitoring, refer to [Flat Tire Monitor 90](#)
- Tire Pressure Monitor [TPM 91](#)
 - resetting the system [92](#)
 - system limitations [91](#)
 - warning lamp [93](#)
- Tire puncture, refer to [Flat Tire Monitor 91](#)
- Tire Quality Grading [210](#)
- Tires
 - age [210, 212](#)
 - air loss [93](#)
 - breaking in [122](#)
 - changing, refer to [Changing wheels 227](#)
 - condition [211](#)
 - damage [211](#)
 - inflation pressure [202](#)
 - labels [210](#)
 - minimum tread depth [211](#)
 - new wheels and tires [212](#)
 - pressure monitoring, refer to [Flat Tire Monitor 90](#)
 - pressure monitoring, refer to [Tire Pressure Monitor TPM 91](#)
 - puncture [91](#)
 - replacing [212](#)
 - Run-Flat [212](#)
 - size [210](#)
 - storage [213](#)
 - tread depth [211](#)
 - wear indicators, refer to [Minimum tread depth 211](#)
 - wheel/tire combination, refer to [Correct wheels and tires 212](#)
 - winter tires [213](#)
- TMC station, refer to [Traffic information 147](#)
- "Tone" [157](#)
- Tone in audio mode
 - adjusting [157](#)
 - middle setting [159](#)
- Tools, refer to [Onboard tool kit 221](#)
- "Top 8" for mobile phone [182](#)
- Torque, refer to [Engine data 236](#)
- Touch tone dialing [184](#)
- Tow bar [232](#)
- Tow fitting [231](#)
 - screw thread [232](#)
- Tow fittings for tow-starting and towing away [231](#)

- Towing [231](#)
 - car with automatic transmission [231](#)
 - methods [232](#)
 - Towing and tow-starting [231](#)
 - Town/city for destination [132](#)
 - "Town / City" in destination entry [132](#)
 - Tow rope [232](#)
 - Tow-starting [231](#), [233](#)
 - "TPM" [92](#)
 - TPM, refer to Tire Pressure Monitor [91](#)
 - Tracks
 - random play sequence [169](#)
 - sampling, Scan [168](#)
 - searching for [168](#)
 - Track width, refer to Dimensions [237](#)
 - Traction control, refer to DSC Dynamic Stability Control [87](#)
 - "Traffic Info" [148](#)
 - Traffic information for navigation
 - calling up [148](#)
 - display on the route map [149](#)
 - during destination guidance [149](#)
 - switching on/off [147](#)
 - Traffic information message list [148](#)
 - Traffic jam
 - displaying traffic information [147](#)
 - driving around [150](#)
 - Transmission
 - automatic transmission with Steptronic [59](#)
 - manual transmission [59](#)
 - overriding selector lever lock for automatic transmission with Steptronic [61](#)
 - Transmission interlock
 - refer to Changing selector lever position [60](#)
 - refer to P Park [60](#)
 - Transporting children safely [53](#)
 - Transport securing device, refer to Securing cargo [125](#)
 - Tread depth, refer to Minimum tire tread [211](#)
 - Treble, refer to Tone control [157](#)
 - Treble, refer to Treble and bass [157](#)
 - Treble, tone control [157](#)
 - "Trip computer" [75](#)
 - Trip computer [75](#)
 - Trip-distance counter, refer to Trip odometer [72](#)
 - "Triple turn signal" [62](#)
 - Triple turn signal activation [62](#)
 - Trip odometer [72](#)
 - Trunk, refer to Cargo bay [114](#)
 - Trunk lid, refer to Luggage compartment lid/tailgate [32](#)
 - Turning circle, refer to Dimensions [237](#)
 - Turn signal indicators [61](#)
 - indicator/warning lamp [12](#)
 - replacing bulbs [224](#)
 - triple turn signal [62](#)
 - Tying down loads, refer to Cargo loading [125](#)
- U**
- Underbody protection, refer to Caring for your vehicle brochure
 - Uniform Tire Quality Grading/UTQR [210](#)
 - "Units" [77](#)
 - Units
 - average consumption [77](#)
 - temperature [77](#)
 - Universal garage door opener, refer to Integrated universal remote control [107](#)
 - Universal mobile phone preparation package, refer to separate Owner's Manual
 - Universal remote control [107](#)
 - Unlatching, refer to Unlocking [36](#)
 - "Unlock button" [30](#)
 - Unlocking
 - from inside [32](#)
 - from outside [29](#)
 - luggage compartment lid [37](#)
 - tailgate [37](#)
 - without remote control, refer to Convenient access [36](#)
 - "Update services" [194](#)
- V**
- Vehicle
 - battery [227](#)
 - breaking in [122](#)
 - care, refer to Caring for your vehicle brochure
 - cargo loading [124](#)
 - Identification Number, refer to Engine compartment [215](#)
 - measurements, refer to Dimensions [237](#)
 - parking [58](#)
 - washing, refer to Caring for your vehicle brochure
 - weight [239](#)
 - "Vehicle / Tires" for unlocking [29](#)
 - Vehicle jack [227](#)
 - Vehicle position, refer to Displaying current position [150](#)
 - Ventilation [104](#)
 - draft-free [104](#)
 - in the rear [105](#)
 - Ventilation, refer to Climate [101](#)
 - Ventilation while at a standstill [105](#)
 - Vents, refer to Ventilation [104](#)
 - "Vent settings" [102](#)
 - Voice commands
 - overview [22](#)
 - short commands [242](#)
 - Voice instructions for navigation system [146](#)
 - muting [52](#), [146](#)
 - repeating [52](#), [146](#)
 - switching on/off [146](#)
 - volume [147](#)

- Voice phone book [187](#)
- Volume [156](#)
- audio sources [156](#)
- fuel tank, refer to Capacities [241](#)
- mobile phone [180](#)
- speed-dependent control [157](#)
- voice instructions [147](#)

W

- Warning and indicator lamps [13](#)
- Warning messages, refer to Check Control [82](#)
- Warning triangle [230](#)
- Washer fluid [63](#)
- content of the reservoir [64](#)
- Washer fluid reservoir [64](#)
- Washing the car, refer to Caring for your vehicle brochure
- Waste tray, refer to Ashtray [112](#)
- Water on roads, refer to Driving through water [123](#)
- Waveband with the radio [160](#)
- "WB" [156](#)
- Wear indicators in tires, refer to Minimum tread depth [211](#)
- Weights [239](#)
- Wheel/tire combination, refer to Correct wheels and tires [212](#)
- Wheelbase, refer to Dimensions [237](#)
- Wheels, new [212](#)
- Wheels and tires [202](#)
- Width, refer to Dimensions [237](#)
- Windows [38](#)
- convenience operation [30](#)
- opening, closing [38](#)
- operation with convenient access [37](#)
- pinch protection system [39](#)
- rear window [35](#)
- safety switch [39](#)

- Windows, indicator on Control Display [16](#)
- Windshield
- cleaning [63](#)
- defrosting and removing condensation [104](#)
- Windshield wash [62](#)
- filling capacity, reservoir [241](#)
- nozzles [63](#)
- rear window [63](#)
- reservoir for washer fluid [64](#)
- washer fluid [64](#)
- Windshield wiper blades, changing [221](#)
- Windshield wipers, blades, care, refer to Caring for your vehicle brochure
- Windshield wipers, refer to Wiper system [62](#)
- Winter tires [213](#)
- setting speed limit [84](#)
- storage [213](#)
- Wiper blade replacement [221](#)
- Wiper system [62](#)
- "With highways" in navigation [141](#)
- Wooden trim, refer to Caring for your vehicle brochure
- Word-matching principle for navigation [142](#)
- Work in the engine compartment [214](#)
- Wrench/screwdriver, refer to Onboard tool kit [221](#)

X

- xDrive [88](#)
- Xenon lamps
- replacing bulbs [222](#)

Y

- Your individual vehicle
- settings, refer to Personal Profile [28](#)

Refueling

So that you always have access to the data you need when refueling, you are recommended to enter the relevant figures for your car in the table provided below. Consult the index for individual specifications.

Fuel

Quality

Please enter your preferred fuel here.

Engine oil

Preferred oil specifications

Do not add engine oil until the corresponding warning lamp in the instrument cluster lights up, refer to page [217](#).

Tire inflation pressures

	Summer tires Front	Rear	Winter tires Front	Rear
Up to 4 persons				
5 persons or 4 plus luggage				

More about BMW

bmwusa.com



The Ultimate
Driving Machine

01 41 0 012 928 ue iDrive

